

Mounting instructions

seamed metal roofs

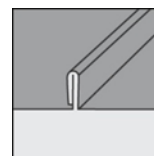

TABLE OF CONTENTS

1	Notes	1
2	Maintenance of the mounting system	4
3	novotegra for seamed metal roofs	4
4	System components, tools and equipment	5
4.1	What is required for mounting	5
4.2	Installation system components – mounting versions	6
4.3	Mounting system components – optional.....	7
5	Installing the mounting system	8
5.1	Clamp mounting.....	8
5.2	Rail mounting	8
5.3	Module mounting	9
5.4	Mounting versions.....	10
5.5	Direct fixing insertion system	13
6	Warranty / product liability (exclusion)	15

1 Notes

The following instructions are generally valid for our mounting system novotegra and are to be applied or interpreted accordingly regardless of the respective roof and mounting system type.

Safety information

Mounting tasks may only be carried out by qualified and competent persons. During the work protective clothing in accordance with the relevant national regulations and guidelines must be worn.

Mounting must be carried out by at least two persons to ensure help in case of an accident.

All relevant national and locally applicable health and safety regulations, accident prevention regulations, standards, construction standards and environmental protection regulations as well as all regulations of the employers' liability insurance associations must be complied with.

The national regulations for working at height / on the roof must be complied with.

Electrical work must be carried out in compliance with the national and locally applicable standards and guidelines and the safety rules for electrical work.

Earthing / equipotential bonding of the mounting system must be carried out in accordance with the national and locally applicable standards and guidelines.

Categorisation into hazard classes

To alert the user of potential danger situations the hazard classes analogous to ANSI Z 535 are used. The hazard class describes the risk if the safety information is not observed.

Warning symbol with signal word

Hazard class analogous to ANSI Z 535



DANGER! describes an immediate danger. If it is not avoided, death or serious injury will result.



WARNING! describes a potential danger. If it is not avoided, death or serious injury might result.



CAUTION! describes a potential danger. If it is not avoided, light or minor injury might result.



NOTE! describes a potentially harmful situation. If it is not avoided, the plant or objects in its vicinity might be damaged.

General information

After receipt the goods must be inspected for completeness using the accompanying delivery note.

novotegra GmbH does not accept the costs, nor can we guarantee subsequent express deliveries if missing material is only noticed during mounting.

Since our mounting systems are subject to continuous development, mounting processes or components may change. Therefore, please check the current status of the mounting instructions on our website prior to mounting. We are also happy to send you current versions upon request.

The mounting system is suitable for the attachment of PV modules with standard market dimensions. Please find more detailed information about this in chapter 3.

The usability of the mounting system for the respective project must be checked for each individual case on the basis of the roof cover / roof construction / facade present.

The roof cover / roof construction / facade must meet the requirements of the mounting system with regard to load bearing capacity, support structure and condition.

Requirements for the material of the roof construction / roof cover / facade:

Wooden components (rafters/purlins): min. strength class C24, no fungus infection or rot

Tensile strength R_m , min for trapezoidal metal: steel 360 N/mm²; aluminium 195 N/mm²

Wall construction material: concrete, brick or sand-lime brick in solid or hollow block design.

The load bearing capacity of the roof / roof construction (rafters, purlins, trapezoidal metal, concrete floors, number of adhesive points, folded seams, etc.) or the facade (wall construction materials) must be checked by the user or a check be commissioned.

Physical building aspects concerning insulation penetrations (e.g. condensation) must be taken into account by the user.

Notes on mounting

The components of the novotegra mounting system are intended exclusively for the attachment of PV modules. Dependent on the roof type of the building the designated mounting system components must be used.

A condition for the intended use of the novotegra mounting system is the mandatory compliance with the specifications in these instructions regarding safety information and mounting.

In case of unintended use and non-compliance with the safety information and mounting instructions and non-utilisation of the corresponding mounting components or use of third party components not belonging to the mounting system any warranty and liability claims against the manufacturer are voided. The user is liable for damage and resulting consequential damage to other components, such as PV modules, or the building as well as personal injury.

The user must read the mounting instructions prior to mounting. Unresolved issues must be clarified with the manufacturer prior to mounting. The mounting sequence in these instructions must be adhered to.

It must be ensured that a copy of the mounting instructions is accessible in the immediate vicinity of the work on site.

The mounting specifications (module load, attachment, clamping areas etc.) of the module manufacturer must be observed and complied with.

Prior to mounting the mounting system must be statically calculated with the loads to be assumed for the building project in accordance with the national standards. Information relevant to mounting (e.g. roof hook distance, lengths of bolts, overhang and protrusions or distance of base trough and required ballast) must be determined by the static calculation using the design software www.solar-planit.

The permissible roof inclination for using the mounting system according to these installation instructions is 0 to 60 degrees for roof-parallel installation on a pitched roof and 0 to 5 degrees for elevated installation on a flat roof. Facade systems must be mounted parallel to the facade.

For roof-parallel installation with the clamping system, two module support rails per module must be mounted symmetrically under the modules for equal load transfer into the substructure. Alternatively, the roof-parallel installation can also be installed with insertion rails.

The specified tightening torques must be adhered to and checked randomly on site.

Notes on static calculations

The mounting system must generally be statically calculated for each individual project using the design software Solar-Planit. Excluding façade systems, the calculation for this will be carried out by the company novotegra GmbH.

The static calculation only determines the load bearing capacity of the novotegra mounting system and also takes account of the attachment to the building (rafters, purlins, trapezoidal metal, facade etc.). The load transfer within the building is not considered (customer static calculations).

The load bearing capacity of the mounting system components is determined on basis of the planned module layout and the underlying building information (project data recording). Deviations from the planning on site may lead to different results.

The load assumptions (load and roof division) are country-specific in accordance with the specifications of the Eurocode load standards. The determination of the loads to be assumed for Switzerland is in accordance with SIA 261.

At pitched roof, the modules may not be fitted above the gable end, ridge and eaves or the facade (increased wind load). At the ridge the modules may be fitted up to max. a theoretical horizontal line with the ridge tile and perfectly flush with the gable end. In the eaves area the modules may reach to max. the end of the roof cover due to loads.

In case of an exposed building position (with wind load e.g. at the edge of a slope) or snow accumulation (e.g. dormer or catchment grill or roof structures like domelights etc) the specifications of the Eurocode load standards or SIA 261 (Switzerland) must be taken into account by the user within his own responsibility. The design software does not consider these cases.

The static calculation of the mounting system is based on the symmetrical placement of the modules on the mounting rails at the longitudinal side of the modules (roof-parallel clamping systems) or on the support components (elevation) for equal load transfer into the substructure. For the insertion system a cross rail arrangement is expected for equal load transfer.

The results calculated with the design software, such as distances of the fasteners (e.g. roof hooks, stock screws, saddle clamps etc.), rail lengths and number of fasteners (e.g. direct attachment on the trapezoidal metal), overhang (e.g. rail and roof hook protrusions) or distances between the base troughs and number of fixing materials (e.g. rail joint) and the other calculation notes must be considered and complied with.

novotegra has been tested and certified by TÜV Rheinland:



2 Maintenance of the mounting system

The mounting system must be checked for stability and operation at regular intervals during the system maintenance.

In addition to the visual inspection of the components, we recommend a random check of the connections and the safe and correct position of the ballast on the base rails and ballast troughs.

Removal is possible in reverse order in the work steps mentioned below.

The maintenance work must be carried out by a specialist company with proven experience in electrical systems and work on mounting systems.

3 novotegra for seamed metal roofs

The contents of this installation manual describe the construction of the substructure on folded seam roof (standing and round seam roofs) or profile sheet roofs (Zambelli RibRoof 465 and 500 or Domico GBS). The maximum permissible module width is 1.34 m for the respective mounting system to be used.

The structural calculation of the mounting system only considers the fastening of the mounting system to the roof covering. The static calculation of the roof covering by the load from the PV construction must be carried out by the customer.

The seam and profile sheet clamps must be attached to every seam in the area of the module array and are suitable for roof coverings made from steel and copper sheet, titanium zinc, aluminium and stainless steel. Depending on the thickness of the sheet and the roofing material, stainless steel saddles may need to be installed beneath the clamps, depending on the clamp.





4 System components, tools and equipment

4.1 What is required for mounting

Clamping system

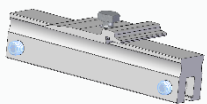
Image	Tool	Component*	Product group
		standing seam clamp set Material: stainless steel and Aluminium Tool: Hexagon socket wrench/bit 5 mm Special long nut socket AF18	Roof attachment
		C-rail Material: Aluminium Tool: Special long nut socket AF18	Profile rails
		Rail connector set Material: Aluminium and stainless steel Tool: Special long nut socket AF18	Rail connectors and expansion joints
		Middle clamp set Material: Aluminium, cast Aluminium and stainless steel Tool: Socket bit AF8	Module attachment
		End clamp set Material: Aluminium, cast Aluminium and stainless steel Tool: Socket bit AF8	Module attachment
		Module slip guard Material: stainless steel	Module protection and rail top cover

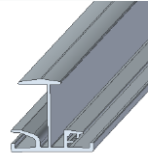
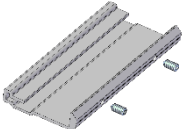
Insertion system

		Standing seam clamp set 150 M8 IR Material: stainless steel and Aluminium Tool: Hexagon socket wrench	Roof attachment
		Insertion rail Material: Aluminium	Profile rails
		Rail connector set IR Material: Aluminium Tool: Hexagon socket wrench	Rail connectors and expansion joints
		Rail connector IR 5 x 100 Material: stainless steel	Rail connectors and expansion joints

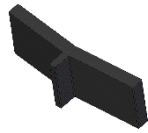

EPDM-T protection IR
Material: EPDM

Module protection
and rail top cover

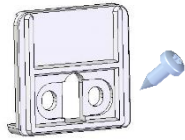

Edge stop set IR
Material: Aluminium and stainless steel
Tool: TORX bit TX30

Module protection
and rail top cover

* The components vary depending on the requirements of the roof, the structural analysis and the choice of components and may deviate from the images above.

Image



Tool

Cordless
screwdriver

Component*

TORX bit TX40
Socket 8 mm

Product group

Component
attachments, clamp
mounting



Torque key
up to at least
50 Nm

Special long nut socket AF18

Rail assembly



Torque key
up to at least
12 Nm

Socket 8 mm

Clamp assembly



Mitre saw

Rail section

4.2 Installation system components – mounting versions

Image

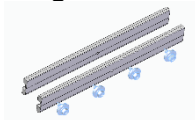

Tool



Component**

Rail connector set C47 S
Material: Aluminium and stainless steel

Product group

Rail connectors and
expansion joints











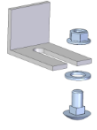

Expansion joint*
Material: Aluminium and stainless steel
Tool: Special long nut socket AF18

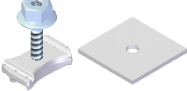
Module support rail

** Required components depending on construction of substructure (e.g. cross rail configuration), system expansion (e.g. using floating bearings) or module arrangement (e.g. horizontal module installation).

4.3 Mounting system components – optional

Image	Tool	Component***	Product group
		C-rail end cap Material: Aluminium and stainless steel Tool: Special long nut socket AF18	Module protection and rail top cover
		Top cover C-rail 2,000 mm Material: Aluminium	Module protection and rail top cover
		End cap C-rail black	Module protection and rail top cover
		Mounting-Set C-rail with plate	Accessories and optional components
		Grounding connector set AF 18 Material: stainless steel Tool: Special long nut socket AF18	Accessories and optional components
		Cable-tie clip for profile flange	Cable fixing
		Cable clip d = 10 mm	Cable fixing
		Contact latch module clamp	Accessories and optional components

*** Optionally available installation system components, e.g. for improving the aesthetics of the system, cable routing or earthing of the installation system.

5 Installing the mounting system

Prior to installation, the module array must be measured out on the roof and the position of the fastening equipment (e.g. roof hooks, hanger bolts, seam clamps, etc.) determined, taking the structural analysis into account.

The individual installation steps for vertical module installation are described below. References are made to installation variants (IV) for the various design possibilities. The associated work steps are described at the end.

5.1 Clamp mounting

Marking out the clamp axis

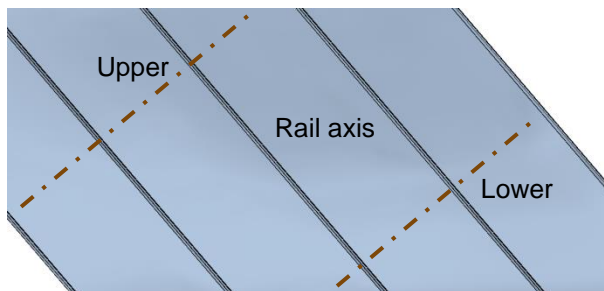

The clamps must be installed centred under the C rails. To do this, first mark out the axis on the roof covering or mark it with the cord. Two rail axes must be provided for each row of modules.

⚠ WARNING

Scaffolding must be constructed in accordance with the relevant regulations.

Attaching the clamps

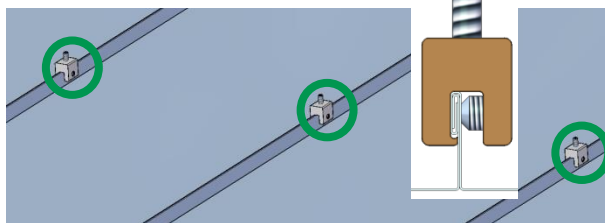

Place the clamp on the seam and fasten using the setscrew. The clamps must not be installed on or near the metal retainers. The image shows the clamp for standing seam roofs. Clamps as per MV 1 and MV 2 are available depending on the roof covering.

NOTICE

Tightening torque for setscrew 18 Nm

5.2 Rail mounting

Installing the rail

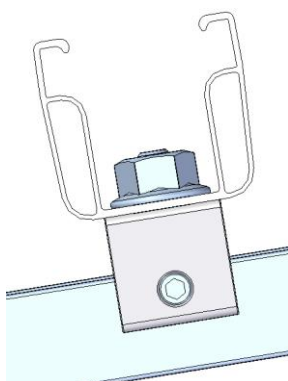

Place the C-rail on the clamp and tighten the rail using the locking bolt. If installing in a cross rail configuration, the upper rail is fastened using cross rail connectors (MV 3).

NOTICE

Tightening torque for locking bolts: 50 Nm.

Connecting the rails

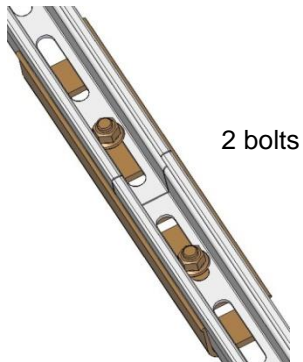

Push the ends of the rails tightly together, place the rail connectors centrally and screw together using the bolts contained in the set. Maximum uninterrupted rail length 3.06 m, after this expansion joints or installation of expansion joints for the C-rail (MV 4).

NOTICE

Tightening torque for locking bolts: 50 Nm.

WARNING

The accident prevention regulations must be complied with during cutting to size

5.3 Module mounting

Securing the module

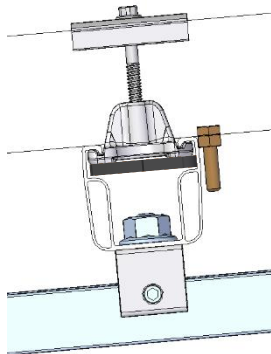

Prior to installing the module, the module slip guard must be mounted on the holes in the frame above the lower rail side (IV 5a/b).

Clamping the module

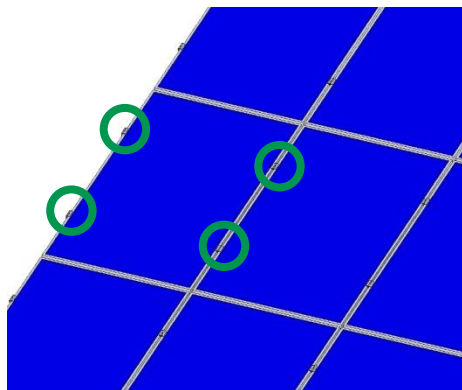

Following this, fasten the modules to the rails using end and middle clamps.

Installing the end and middle clamps

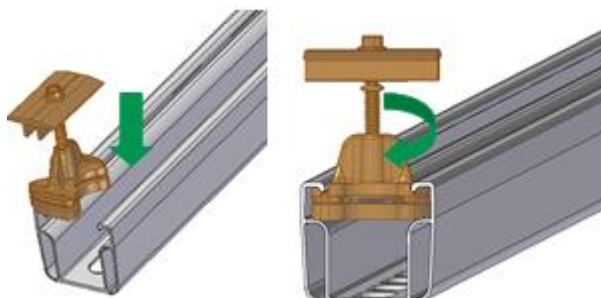

Insert the end or middle clamps into the rail cavity from above at the clamping position. Next, turn the rail nut in the rail and push the module clamps onto the module frame.

Space requirement for end and middle clamps

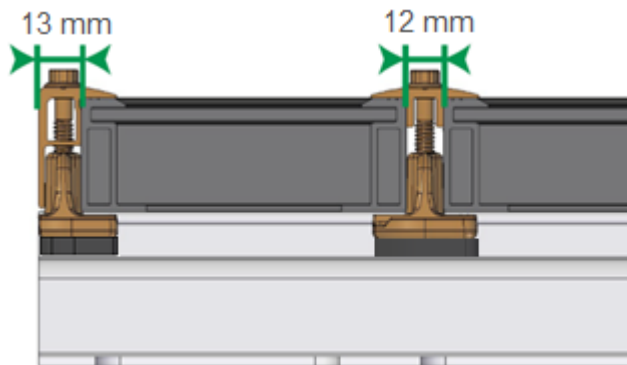

The end clamp can also be installed flush with the rail end.

Push the modules fully to the rail nuts of the middle clamps.

NOTICE

Tightening torque for middle clamps: 12 Nm, tightening torque for end clamps: 8 Nm.

5.4 Mounting versions

Explanation of the installation variants depending on the roof construction or design variants (e.g. round seam clamps or cross rail configuration).

MV 1 – Clamp set for copper roof covering

Stainless steel saddle

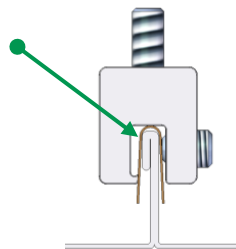
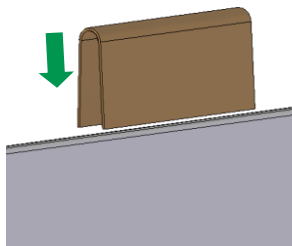

Standing seam clamp set for copper:

- For copper standing seam roofs
- Install the stainless steel saddle (image left)
- Place the clamp in position
- Fasten the clamp with the setscrew
- Tightening torque 20 Nm

NOTICE

The clamps must not be installed on or near the metal retainers.

MV 2 – Clamp set variants

MV 2.1 Rounded seam clamp set

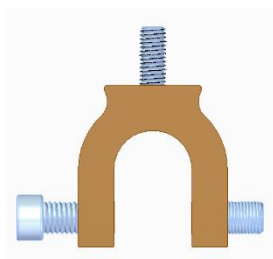

Variant 1

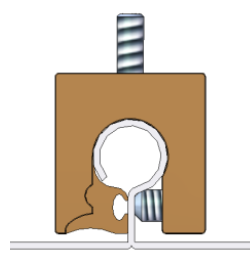

Variant 2

Round seam clamp set:

- For Kalzip roof coverings
- Place the clamp in position
- Push in the clamp insert
- Fasten the clamp with the setscrew
- Tightening torque 15 – 17 Nm

NOTICE

The clamps must not be installed on or near the metal retainers.

MV 2.2 Profiled metal sheet clamp set ZD

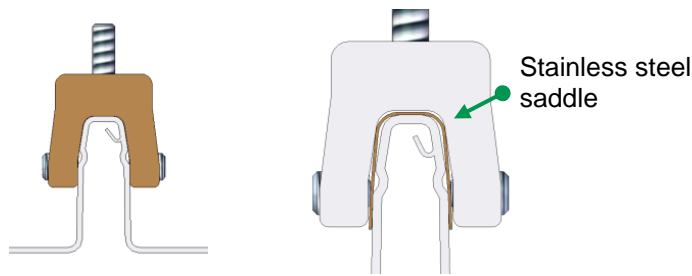

For Zambelli RibRoof 465 and Domico GBS roof coverings

- Material thickness = 0.7 mm requires installation of a stainless steel saddle (image right)
- Place the clamp in position
- Fasten the clamp with the setscrew on both sides
- Tightening torque for material thickness > 0.7 mm = 15 Nm
- Tightening torque for material thickness = 0.7 mm = 17 Nm

NOTICE

The clamps must not be installed on or near the metal retainers.

MV 2.3 Profile metal sheet clamp set Z

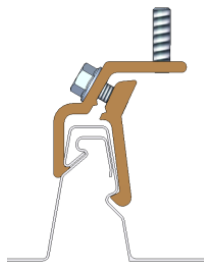

Profile sheet clamp set Z:

For Zambelli RibRoof 500 roof coverings
Place the clamp in position and click into place

Fasten the clamp with both screws (open-end wrench 13 mm)

Tightening torque 25 Nm

The clamps must not be installed on or near the metal retainers.

MV 3 – Rail connectors

MV 3.1 – Mounting of the rail connector C47 S

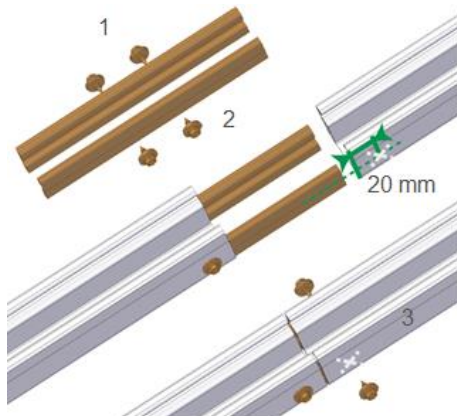

Push the rail connector set (1) halfway into one of the rails to be connected (2) and secure it there with a drilling screw each on both sides approx. 20 mm from the rail end. Next push the other rail completely onto the rail connector set until both rail ends make contact (3) and screw it tight as described above. Maximum uninterrupted rail length 5,50 m, then consider system separation or expansion joint.

WARNING

The accident prevention regulations must be complied with during cutting to size.

MV 3.2 – Installing expansion joints on C-rails

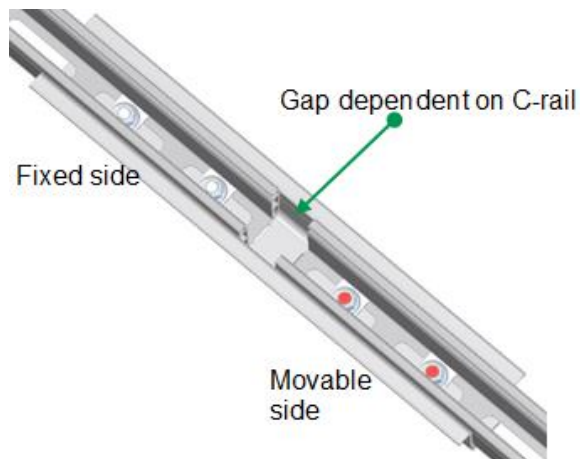

Place rail ends onto the gap, apply the rail connector and connect it to the rail at the fixed and movable sides using the mounting screws. Tighten the screws firmly on the fixed side. The screws on the movable side are coated in red and must be released again after tightening (approx. ½ turn). Maximum rail length with expansion joint 5,50 m, then consider system separation or expansion joint.

NOTICE

Self-locking nut tightening torque fixed side 50 Nm.

Distance of adjacent rail ends

C-rail 38 and 47: 20 mm

C-rail 71 and 95: 40-50 mm

MV 4 Module slip guard for modules with box frame

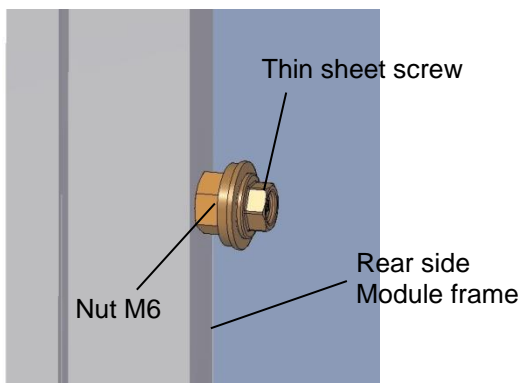

Push the nut over the screw and screw the thin metal screw into the module frame without pre-drilling.

NOTICE

The thin metal screw must not be overtightened.

MV 5 – Grounding

Assembly of contact latch

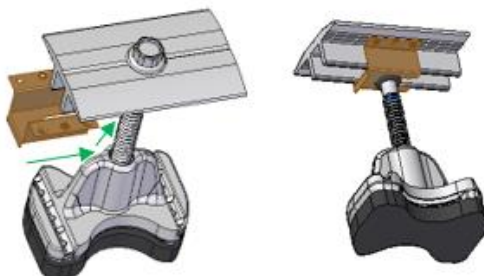

Push the contact latch on the sliding plate over the vertical webs of the middle clamp up to the screw.

NOTICE

Mounting of the middle clamp with the contact latch attached is carried out as described previously in chapter 5.3.

5.5 Direct fixing insertion system

Measuring the insertion rails

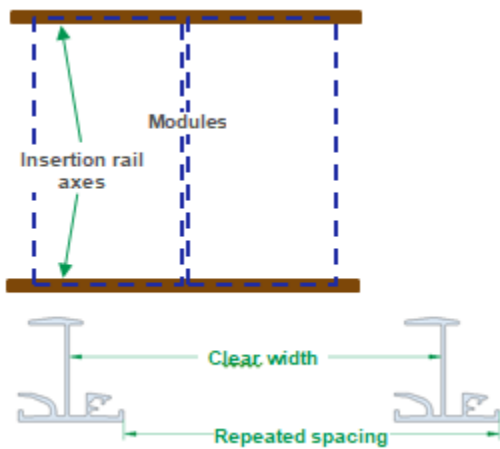

Mark the mounting axes of the insertion rails on the trapezoidal metal raised beads dependent on the module orientation – portrait or landscape.

NOTICE

Repeated spacing = module length $L + 12$ mm

Clear rail width = module length $L + 10$ mm
For mounting modules in landscape the module width instead of the module length must be used.

Insertion system on short profiles according to MV 4 to 7.

Frameless modules:

Repeated spacing = module length $L + 22$ mm

Clear rail width = module length $L + 20$ mm

Mounting the standing seam clamp set 150 M8 IR

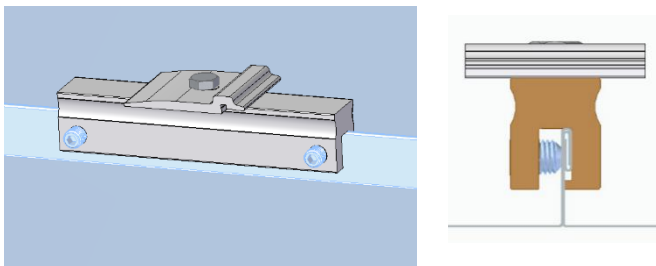

Place the clamp on the seamed metal and fix it with both grub screws. The clamps must not be mounted on or in the area of sheet metal clamps.

NOTICE

Tightening torque of the grub screws 18 Nm

Installation of the insertion rails

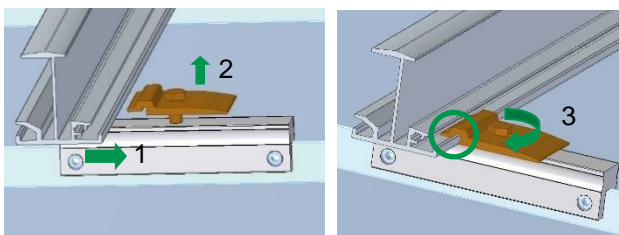

Place the insertion rail on the standing seam clamp 150 M8 IR, push it against the cross rail connector IR(1) and hook it into the holding flange (2), align the rail and tighten the hexagon screw (3).

NOTICE

Tightening torque for the hexagon screw 25 Nm.

Position of the standing seam clamp 150 M8 IR

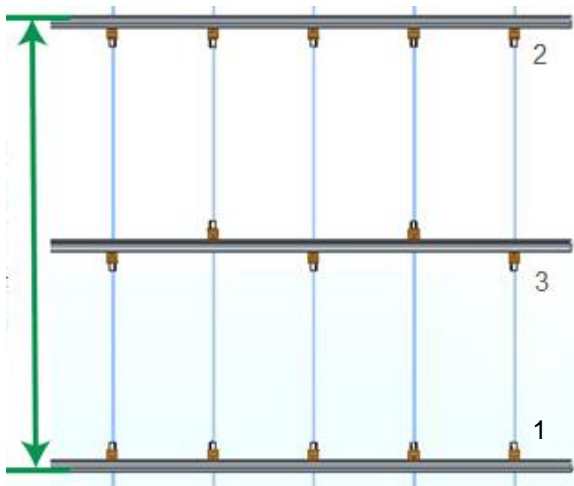

For the top and bottom insertion rail of the module field the standing seam clamp 150 is fitted on the inside in each case (1,2), at the centre insertion rails the standing seam clamp 150 must be fitted alternating at the top and the bottom at the mounting flange (3).

NOTICE

Length of module field =
Repeated spacing x number of module fields
+ width of insert rail

Maximum rail length without interruption
5,50 m

Connect the insertion rails

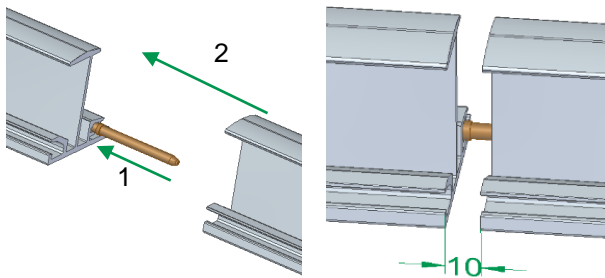

Push the connector into the secured rail piece up to half way into the screw channel, then push the loose rail piece with the screw channel onto the connector with a 10 mm gap between the rail ends, then attach the second rail piece.

NOTICE

Mounting Rail connector IR on short profiles according to MV 7.

WARNING

Rails secured only through the connector are not permitted. Both rail pieces must be attached using trapezoidal sheet brackets.

5.6 Module mounting: insertion system

Module installation insertion system

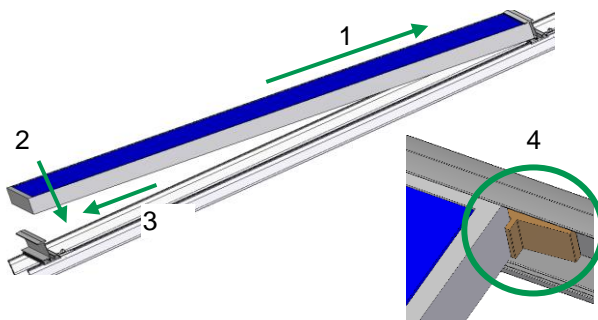

Place the module onto the top insertion rail and push it up (1). Then lower the module onto the bottom insertion rail (2) and push it down against the insertion rail (3). Mount the next modules following the same principle, the gap between the modules must be min. 3 mm.

NOTICE

Install the EPDM-T protection IR between the modules (4) with a module inclination <math>< 10^\circ</math> or as theft protection.

Edge stop mounting

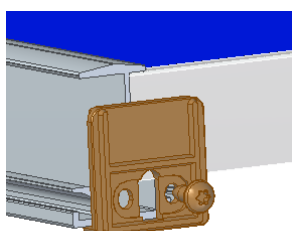

Fit an edge stop at the end of a module row at each insertion rail with a metal screw in the screw channel.

NOTICE

The opening of the edge stop must expose the drainage channel of the insertion rail.

6 Warranty / product liability (exclusion)

In addition to the above-mentioned regulations and safety notices the applicable regulations and rules of technology must be observed by the installing specialist company.

The installer is responsible for the dimensioning of the mounting system.

The installer is responsible for the connection of the interfaces between the mounting system and the building. This also includes the tightness of the building envelope.

For flat roofs the roof insulation must be evaluated by the installer on site within his own responsibility regarding the material of the sealing layer, resistance, ageing, compatibility with other materials, overall condition of the roof insulation, need for a separating layer between the roof insulation and the mounting system. The required and necessary measures or precautions for the protection of the roof insulation for the mounting of the substructure of a PV system must be initiated by the installer with the aid of a specialist tradesman where necessary. novotegra GmbH does not accept liability for faulty or inadequate measures and precautions for the protection of the roof insulation!

The installer must review the friction coefficient used in the calculation for the verification of the slip safety of PV systems on flat roofs on site. Friction coefficients determined on site can be taken into account by entering them in the Solar-Planit planning tool. novotegra GmbH does not guarantee the correctness of the assumed values and is not liable for damage due to the use of incorrect values.

The specifications of the module, cable and inverter manufacturers must be observed. If these contradict the mounting instructions, always consult the novotegra GmbH sales team before mounting the novotegra mounting system or – in the case of components not supplied by novotegra GmbH – the manufacturer concerned.

During the preparation of the offers for novotegra by our sales staff the local conditions are not always sufficiently known, which is why changes to the offered quantities may result during installation. These changes relate mainly to the number of fasteners for the building envelope (for example roof hooks). In this case the additionally required components must always be installed in accordance with the dimensioning.

novotegra GmbH is not liable for incorrect or incomplete data collection sheets. Error-free and fully completed data collection sheets are essential for correct dimensioning.

The information in the mounting instructions, the warranty terms and the information about the liability exclusion must be noted.



novotegra

novotegra GmbH

Eisenbahnstraße 150
72072 Tübingen | Deutschland

Tel. +49 7071 98987-0
Fax +49 7071 98987-10

info@novotegra.com
www.novotegra.com

