



PROMOFOLDER
01/04/2024 - 30/09/2024

NIEUWIGHEDEN

Artikel	Pagina
WT001GZ	9
JV002GZ	20
191L77-9	25
1911V6-0	25
1910N6-8	26
EUADML818	69
EUAML012G	69
1913G0-9	70
1911L1-0	76
VC011GZ	79
VC010GZ	80
VS001GZ	85
LS0816F	103
LS1110F	103
MAC210Q	106
LM003GZ	112
LM003GM102	112
LM004GZ	112
LM004GM102	112
UV001GZ	113
UB003CZ	122
1913P8-6	126
DUP180Z	128
DCU601Z	129
DCU602Z	129

COMBOPACKS









Artikel	Pagina
Combopacks XGT	22-23
Combopacks LXT	57-59
Combopacks CXT	70
Combopacks cleaning	77
Combopacks slijpers	96
Combopacks zaagmachines	101
Combopacks tuin	131

PROMOTIES

Artikel	Promotie	Pagina
DF001GM201	E-05337 + E-05094	8
HP001GM201	E-05337 + E-05094	8
TD001GZ02	DEAML006G	8
TW007GD201	E-16586	9
CE001GZ	E-12996	16
LS002GZ01	DEBWST06	21
LS004GZ01	DEBWST06	21
LS003GZ01	DEBWST06	21
DK0114G201	BL4025	22
DK0124G201	BL4025	22
DK0125G301	BL4040	22
DK0126G401	BL4040 + DC40RA	23
DK0128G601	BL4040 + DC40RA	23
DHR243RTJ	BL1850B	36
DTW300RTJ	E-08458	39
DTD153RTJ	194281-7	41
DHS680RTJ	BL1850B	44
DBO480RTJ	BL1830B	48
DBO481RTJ	BL1830B	48
DBO482RTJ	BL1830B	48
DCE090ZX1	E-03006-25	51
DCE090T2X1	E-03006-25	51
DGA506T1J	D-18770-10	52
DGA508T1J	D-18770-10	52
DGA506RTJ	BL1850B	52
DGA508RTJ	BL1850B	52

PROMOTIES

DTR180ZJ	191A57-9	54
DLX2289T3J	BL1830B	57
DLX2189T3J	BL1830B	57
DLX2440TJ	BL1830B	57
DLX2236TJ1	BL1830B	57
DLX2434TJ	BL1830B	57
DLX2418TJ	BL1850B	58-59
DLX4159TJ	BL1850B	58-59
DLX5093TJ	2x BL1850B	58-59
DLX5071TJ	2x BL1850B	58-59
DLX6128JX1	TR00000001	58-59
DLX1055JX1	TR00000001	58-59
DLX1122JX1	TR00000001	58-59
DHR243Z	D-42444	60
DHR243T1J	D-42444	58
DGA506T1J	D-18770-10	59
DGA508T1J	D-18770-10	59
CLX228SAX2	DEAML103	70
DCL182Z	199491-1 + 458571-5	76
DCL280FZW	191D71-3 + 458571-5	76
HR2630TX12	D-42444	86
HR2631FT12	D-42444	86
HR2651TX12	D-42444	86
HR4013C	P-52445	87
HR4511C	P-52445	87
HR5212C	P-52445	87
HM0871C	E-20236	88
HM1812	D-54972	89
GA5092X01	195354-9	94
GA5090X01	195354-9	94
GA5091X01	195354-9	94
GA5095X01	195354-9	94
GA5094	195354-9	94
GA5093X01	195354-9	94
LS1019	DEBWST06	103
LS1219	DEBWST06	103
SKR200Z	P-81315	107
SK105DZ	BL1021B + DC10SB	108
SK105GDZ	BL1021B + DC10SB	108
SK106DZ	BL1021B + DC10SB	108
SK106GDZ	BL1021B + DC10SB	108
SK10GDZ	197658-5	108
SK20GDZ	197658-5	108
SK40GDZ	197658-5	108
SK209GDZ	197658-5	108
SK312GDZ	197658-5	108
SK700DZ	197658-5	109
SK700GDZ	197658-5	109
LM001GZ	BL4040	112
LM002GZ	BL4040	112
UM600DSAEX	831253-8	118
DUM604RFEX	831253-8	118
DUM111SYX	831253-8	118
DUC256Z001	E-08458	124
DUC356Z001	E-08458	124
DUC406Z001	E-08458	124
DUC306Z001	E-08458	124
DCU180Z	199009-8	129

	XGT - 40Vmax	6
	LXT - 18 V / 2 x 18 V	30
	Outdoor	62
	CXT - 12Vmax	70
	Cleaning	76
	Elektrisch	86
	Lasers	107
	Tuin	110



Makita Service

Makita staat bekend om zijn expertise, kwaliteit en service...

Maar wat maakt de service van Makita nu zo uniek? Wij vroegen het aan Yves (supervisor) en Johan (teamleader) van de technische dienst.

Help, mijn machine is stuk!

"Als er iets aan de hand is met je machine, kan je je toestel best binnenbrengen bij een erkende Makitadealer. Die kan je vinden via de dealerlocator op onze website. Sommige dealers zijn servicedealers en doen de reparaties zelf, de anderen sturen de toestellen op naar ons. Die toestellen komen dan binnen op de hersteldienst bij Makita Kortenbergh of Charleroi. Per jaar repareren wij zo'n 30.000 machines."

Hoelang duurt een reparatie?

"Wij streven naar een reparatie binnen de 24 tot 48 uur. We zijn sowieso al snel omdat de verzending van de dealer naar onze magazijnen vlotter verloopt dan wanneer de herstelling in het buitenland gebeurt. Wanneer een machine binnenkomt bekijken we het vrijwel meteen. Het Makitagereedschap is ook zo gemaakt dat het gemakkelijk te herstellen is. Alles is bijvoorbeeld met dezelfde schroeven vastgemaakt. Veel servicedealers zeggen dat ze het liefst aan een Makita sleutelen."

"Soms kan een herstelling langer duren dan verwacht omdat we een onderdeel moeten bijbestellen. Dat gebeurt niet zo heel vaak, aangezien wij 185.107 onderdelen in onze magazijnen hebben klaarliggen. Wij houden de stukken voor machines soms jaren bij, we hebben zelfs nog stukken uit 1980."

Hoe werkt de garantie bij Makita?

"Op gebied van garantie hebben particulieren twee jaar garantie en professionals één jaar, dat is wettelijk bepaald. Wanneer je het toestel registreert via MyMakita op onze website kan je wel tot drie jaar garantie krijgen, ongeacht of je een professional of een particulier bent."

Wat als het toestel niet (meer) onder garantie is?

"Je kan je toestel nog altijd laten maken. Vanaf de reparatie duurt er dan 45% van de nieuwprijs maken wij een bestek op. Dan geven wij dit door via de dealer."

"We krijgen wel vaker machines binnen die niet meer onder garantie zijn, zo deed ik overlaats nog een reparatie voor een klopper uit 1982. Sommige machines zijn zo oud dat er zelfs geen datum opstaat. Machines uit 2000 komen nog heel vaak binnen, wij stellen dan wel eerst een voorstel voor de klant op, zeker als de machine al meer dan 20 jaar oud is."

"Je kan trouwens ook het onderhoud van je machines laten doen bij Makita, dat kunnen klanten aanvragen bij hun dealer. Wanneer we het toestel bekijken en we vinden dat geen onderhoud nodig is, doen we dat ook niet."

20 MEDEWERKERS



OP DE TECHNISCHE DIENST



30.000+
herstellingen per jaar

185.107

onderdelen in de magazijnen



**Makita blijft de
Rolls Royce van
het elektrisch
gereedschap**

Wat maakt de service van Makita uniek?

Johan: "We werken heel snel door onze eigen herstellingsdiensten in België. Daardoor is die prijs-kwaliteit uitstekend, de klant betaalt niet veel voor goede herstellingen."

Yves: "Het is eigenlijk bijna ambachtelijk. We analyseren elk toestel grondig, herstellen wat kapot is en werken niet in modules. Tot het kleinste vijsje kan bij ons vervangen worden. Dat is duurzamer én goedkoper voor de klant."

"Bovendien zijn wij telefonisch bereikbaar. Klanten kunnen hun verhaal doen, zo weten wij ook beter hoe we het toestel moeten repareren. Op die manier kunnen wij klanten op de hoogte houden van hun herstelling en een bestek opmaken. Dan kan de klant zelf nog beslissen of die de herstelling wil laten uitvoeren voor de voorgestelde prijs of het wil omruilen voor een vergelijkbaar toestel met 10% korting. Ook de servicedealers kunnen ons altijd bereiken als er iets niet lukt met hun herstelling. Die servicedealers krijgen trouwens ook hun opleiding door ons, bij Makita. Op die manier geven we de beste ondersteuning aan dealers en eindklanten."

Yves: "Als je het mij vraagt, de service van Makita is formidabel en gebouwd op een team." Een team met veel ervaring. Alle knowhow zit dan ook onder één dak bij Makita: onze customer service en technische dienst kunnen met elkaar in gesprek gaan en dat is een meerwaarde. U weet waarover u praat. Wij ook.



GEKSTE MACHINE

Johan: "We kregen ongeveer een jaar geleden een tandvrij voor paarden binnen. Paarden hebben kiezen die blijven groeien en dan bijgevoild moeten worden. Lang geleden verkochten we dit bij Makita en soms duikt er nog eens eentje op voor een reparatie."

TIPS

"Jouw machines graag zien en de handleiding lezen..."

MAKITA IN ÉÉN ZIN

"Makita blijft de Rolls Royce van het elektrisch gereedschap."

XGT

40V **Li-ion** max



Next Generation Technology

XGT is een nieuw platform met specifieke machines, accu's en laders. De combinatie van Makita's bewezen motortechnologie, geavanceerde elektronische sturing en kwalitatieve 40Vmax-batterijen biedt een geweldig alternatief voor de meest veeleisende gebruiker. Het XGT-platform vult het bestaande CXT- en LXT platform aan maar vervangt deze niet. Het is de volgende, logische stap naar een snoerloze toekomst en zorgt voor een oplossing op accu voor de zwaarste toepassingen.

Digitale communicatie

Op het XGT-platform kunnen de machines en accu's nu ook onderling digitaal communiceren via geïntegreerde elektronica. Dat resulteert in een perfect energiemangement, optimale prestaties en bovendien een effectieve bescherming van alle componenten bij extreme belasting.

Optimaal laden

Digitaal geoptimaliseerd laadtraject met twee ventilatoren voor een perfecte temperatuurcontrole en continue actieve bijsturing van het laadtraject. Het resultaat zijn nog snellere laadtijden en een langere levensduur van de batterijen.



De nieuwste innovatie in accugereedschap



KRACHTIG



TOEKOMST-GERICHT



INTELLIGENT



BETROUW-BAAR

MAKITA ACCUPLATFORMEN

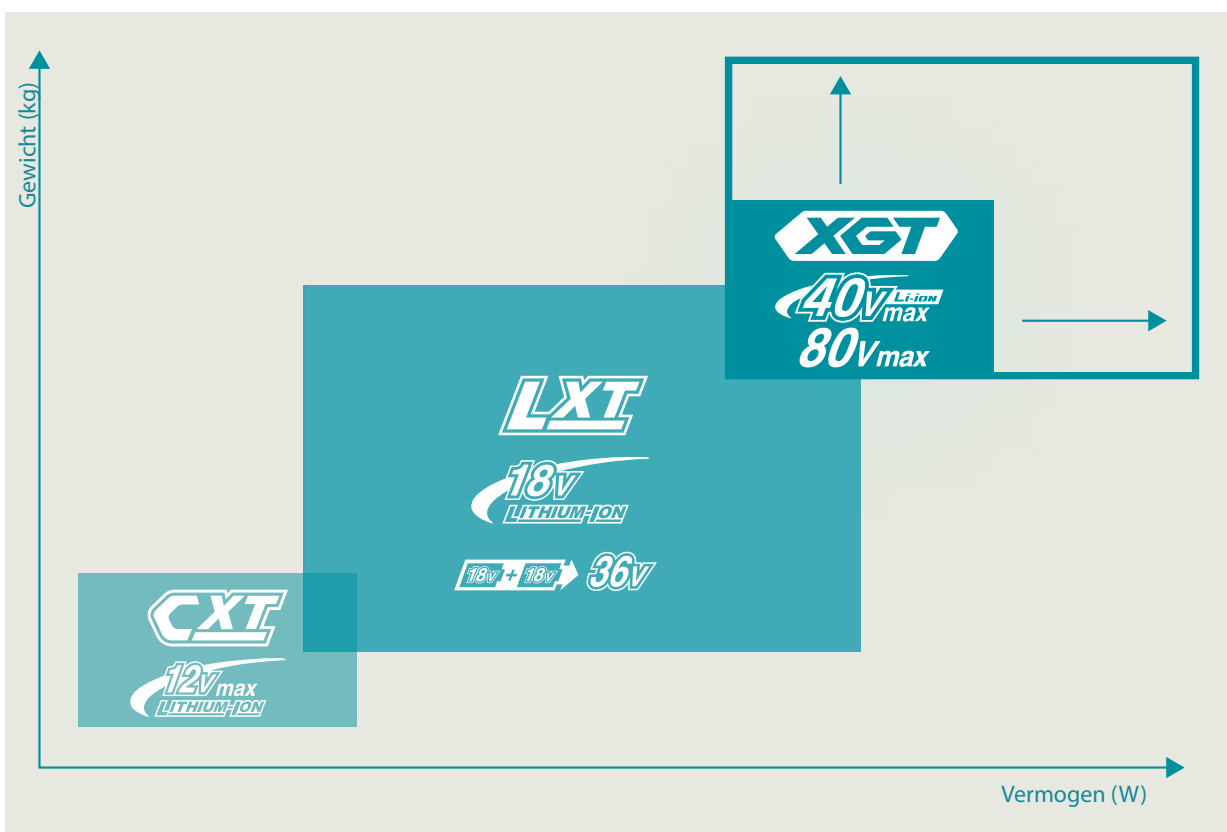

CXT 10,8V (12Vmax)

Het CXT accuplatform is de basis voor het 10,8V (12Vmax) accugereedschap van Makita. Makita-accu's uit het CXT-systeem zijn verkrijgbaar met een capaciteit tot 5,0 Ah (54 Wh). CXT accu's vormen een ideale combinatie met kleinere machines die vooral compact en licht moeten zijn (bijvoorbeeld voor het werken op moeilijk bereikbare plaatsen).

LXT 18V

Het LXT platform heeft zich ontwikkeld tot het systeem met het grootste gamma compatibele machines. LXT accu's zijn verkrijgbaar met een capaciteit tot 6,0 Ah (108 Wh). Met de LXT-serie biedt Makita een accu voor ruim 420 machines en tuingereedschap. In het geval van 2x 18V machines worden twee LXT accu's gecombineerd voor nog meer vermogen en/of een grotere autonomie. In dit segment vindt de gebruiker professionele tools voor (bijna) elke toepassing.

XGT 40Vmax

De XGT-klasse met eigen machines, accu's en lader vormt een aanvulling op de beproefde CXT- en LXT-plattform. De XGT-accu's zijn zeer robuust en ontworpen voor gebruik in zware omstandigheden. De 2x 40Vmax machines gebruiken twee XGT accu's voor nog meer vermogen en/of autonomie. XGT accu's zijn verkrijgbaar met een capaciteit tot 8,0 Ah (288 Wh). Het XGT systeem biedt de hoogste prestaties en snelste laadtijden hetgeen ook nieuwe toepassingsgebieden in de bouw, industrie, facility management en groenbeheer mogelijk maakt.



HP001GM201

DF002GD201

HP001G / DF001G

- Maximaal koppel tot 140 Nm
- Tot 35 % hogere snelheid
- Bestand tegen continu werken onder hoge belasting



41 elektronische koppelinstellingen
Voor een groter instelbereik en grotere nauwkeurigheid.



Active Feedback sensing Technology
Schakelt de machine uit bij een plotse zwenkbeweging.



DF001GM201 & HP001GM201: gratis gereedschapsriem E-05337 + holster E-05094

	DF001GZ01	DF001GM201	DF002GZ01	DF002GD201	HP001GZ01	HP001GM201	HP002GZ01	HP002GD201
Spanning	36 V (40Vmax)	36 V (40Vmax)	36 V (40Vmax)	36 V (40Vmax)	36 V (40Vmax)	36 V (40Vmax)	36 V (40Vmax)	36 V (40Vmax)
Bijgeleverde accu's	0	2 x BL4040	0	2 x BL4025	0	2 x BL4040	0	2 x BL4025
Lader	-	DC40RA	-	DC40RA	-	DC40RA	-	DC40RA
Max. koppel zacht / hard	68 / 140 Nm	68 / 140 Nm	30 / 64 Nm	30 / 64 Nm	68 / 140 Nm	68 / 140 Nm	30 / 64 Nm	30 / 64 Nm
Boorkop	1,5 - 13 mm	1,5 - 13 mm	1,5 - 13 mm	1,5 - 13 mm	1,5 - 13 mm	1,5 - 13 mm	1,5 - 13 mm	1,5 - 13 mm
Klopboorfunctie	-	-	-	-	✓	✓	✓	✓
Gewicht	2,7 kg	2,7 kg	2,5 kg	2,5 kg	2,7 kg	2,7 kg	2,6 kg	2,6 kg
Prijs in €	excl. btw	€ 275,00	€ 175,00	€ 535,00	€ 285,00	€ 739,00	€ 185,00	€ 549,00
	incl. btw	€ 332,75	€ 894,19	€ 211,75	€ 647,35	€ 344,85	€ 223,85	€ 664,29



TD003GZ01



TD002GZ04



Promo: gratis DEAML006G bij TD001GZ02

NIEUW

	TD003GZ01	TD001GZ02	TD002GZ04
Spanning	36 V (40Vmax)	36 V (40Vmax)	36 V (40Vmax)
Bijgeleverde accu's	-	-	-
Lader	-	-	-
Bitopname	1/4" hex	1/4" hex	1/4" hex
Max. koppel	210 Nm	220 Nm	220 Nm
Slagkrachtniveaus	4	4	4
Hulpfuncties	1	6	6
Gewicht	1,7-2,9 kg	1,7-2,9 kg	1,7-2,9 kg
Prijs in €	excl. btw	€ 199,00	€ 269,00
	incl. btw	€ 240,79	€ 325,49

NEXT GENERATION TECHNOLOGY

ACCU SLAGMOERSLEUTELS



TW001G

BL-motor



Uiterst compact



3 hulpfuncties voor het automatisch stoppen van de rotatie, zowel bij het vastdraaien als het losdraaien.



TW004GD201

TW007GD201

Robuust slagmechanisme



Promo: gratis 14-delige doppen-set IMPACT BLACK E-16586 bij TW007GD201

HULPFUNCTIES VOOR HET VASTDRAAIEN EN LOSDRAAIEN VAN BOUTEN

	Rechtsom (vastdraaien)	Linksom (losdraaien)
Boutfunctie	Deze functie helpt om continu schroeven erin te draaien met hetzelfde aandraaimoment. Deze functie helpt ook de kans te verkleinen dat de bouten/ moeren breken als gevolg van te strak vastdraaien.	Deze functie helpt voorkomen dat een bout eraf valt. Bij het losdraaien van een bout, zal het gereedschap automatisch stoppen of langzamer gaan draaien zodra de bout/moer voldoende los zit.
mode 1	Het gereedschap stopt automatisch zodra de slagwerking is begonnen.	Het gereedschap stopt automatisch zodra de slagwerking is gestopt.
mode 2	Het gereedschap stopt automatisch ongeveer 0,5 seconde na het moment waarop de slagwerking is begonnen.	Het gereedschap stopt automatisch ongeveer 0,2 seconde na het moment waarop de slagwerking is gestopt.
mode 3	Het gereedschap stopt automatisch ongeveer 1 seconde na het moment waarop de slagwerking is begonnen.	Het gereedschap gaat langzamer draaien nadat de slagwerking is gestopt.

	TW004GZ	TW004GD201	TW007GZ01	TW007GD201	TW001GZ01	
Spanning	36 V (40Vmax)	36 V (40Vmax)	36 V (40Vmax)	36 V (40Vmax)	36 V (40Vmax)	
Bijgeleverde accu's	0	2 x BL4025	0	2x BL4025	0	
Bijgeleverde lader	-	DC40RA	-	DC40RA	-	
Toerental	0-3200 tpm	0-3200 tpm	600-2300 tpm	600-2300 tpm	0-1800 tpm	
Max. koppel	350 Nm	350 Nm	760 Nm	760 Nm	1800 Nm	
Dopaaansluiting	1/2"	1/2"	1/2"	1/2"	3/4"	
Verpakking	-	Makpac	Makpac	Makpac	Makpac	
Gewicht	1,9 - 2,2 kg	1,9 - 2,2 kg	2,7 - 3,3 kg	2,7 - 3,3 kg	3,9 - 4,2 kg	
Prijs in €	excl. btw	€ 255,00	€ 635,00	€ 339,00	€ 689,00	€ 379,00
	incl. btw	€ 308,55	€ 768,35	€ 410,19	€ 833,69	€ 458,59



ACCU BREEKMOERSLEUTEL



- Voor het vastzetten van breekbouten (type HTB en SHTB)
- Compatibel met boutmaten M16 – M20 – M22
- Accessoires voor M20 en M22 bijgeleverd
- Breekbouten worden vooral gebruikt bij industriële staalconstructies.

		NIEUW WT001GZ
Spanning		40Vmax
Accu's/lader		-
Toerental onbelast		17 min ⁻¹
Max. koppel		804 Nm
Compatibiliteit HTB		M16, M20, M22
Compatibiliteit SHTB		M16, M20
Gewicht		5,2 - 5,9 kg
Prijs in €	excl. btw	€ 1.999,00
	incl. btw	€ 2.418,79

4-snijder hamerboren met lasergelaste hardmetalen boorpunt

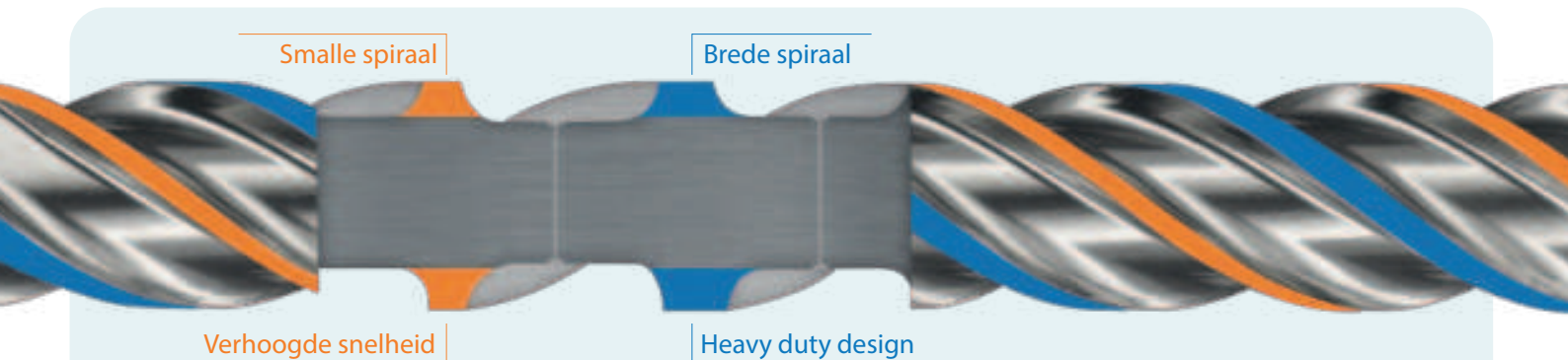

Smalle spiraal

Brede spiraal

Verhoogde snelheid

Heavy duty design

Hogere Snelheid

- > De smalle spiraal zorgt voor minder wrijving en snellere boorprestaties!
- > Vlottere afvoer van het boorgruis dankzij het lasergelaste boorpunt en de dubbele spiraal.
- > Lasergelaste carbide boorpunten t.e.m. \varnothing 16 mm.

Zware klus

- > De brede spiraal zorgt voor een structurele versterking van de kern en minder last van slijtage.
- > Dankzij het robuust ontwerp is de Nemesis II-boor veilig, geschikt voor de zwaaste klus en loopt ze niet vast op betonstaal.

Langere levensduur

- > Verhoogde weerstand tegen oververhitting dankzij het lasergelaste boorpunt.
- > Het solide uit 1 stuk vervaardigd hardmetalen boorpunt zorgt voor lage vibraties en optimale boorprestaties.

\varnothing 5 – 10 mm

4-snijder: Solide hardmetalen boorpunt



\varnothing 11 – 16 mm

4-snijder: Solide uit één stuk vervaardigd hardmetalen boorpunt



SCAN HIER



Voor volledige assortiment

\varnothing 18 – 32 mm

4-snijder: Solide driedelig hardmetalen boorpunt



NEXT GENERATION TECHNOLOGY

ACCU HAAKSE BOORMACHINE



DA001GM101

- Zeer hoog koppel (136 Nm)
- Twee mechanische snelheden
- Ingebouwde mechanische slipkoppeling

		DA001GZ01	DA001GM101
Spanning		36 V (40Vmax)	36 V (40Vmax)
Bijgeleverde accu's		-	1 x BL4040
Bijgeleverde lader		-	DC40RA
Toerental		0 - 400 t.p.m. 0 - 1500 t.p.m.	0 - 400 t.p.m. 0 - 1500 t.p.m.
Hard koppel		70/136 Nm	70/136 Nm
Boorkop		13 mm	13 mm
Gewicht		5,3 - 6,2 kg	5,3 - 6,2 kg
Prijs in €	excl. btw	€ 545,00	€ 829,00
	incl. btw	€ 659,45	€ 1.003,09

ACCU COMBIHAMERS SDS-PLUS



HR010GZ01



HR007GM201

HR010G

- Licht, compact en toch krachtig
- Speciale behuizing en handgreep reduceren de trillingen
- Optioneel verkrijgbaar: DX16 stofafzuigingsunit
- De perfecte oplossing voor het boren van kleinere diameters!



HR002GM204



HR009GZ02

		HR010GZ01	HR007GZ01	HR007GM201	HR002GZ02	HR002GM204	HR009GZ02	HR009GM202
Spanning		36 V (40Vmax)	36 V (40Vmax)	36 V (40Vmax)	36 V (40Vmax)	36 V (40Vmax)	36 V (40Vmax)	36 V (40Vmax)
Bijgeleverde accu's		-	-	2 x BL4040	-	2 x BL4040	-	2 x BL4040
Lader		-	-	DC40RA	-	DC40RA	-	DC40RA
Slagenergie		2,0 J	3,0 J	3,0 J	2,9 J	2,9 J	3,9 J	3,9 J
Max. Ø beton		20 mm	28 mm	28 mm	28 mm	28 mm	30 mm	30 mm
AFT		-	✓	✓	✓	✓	✓	✓
Trillingsniveau (ah)		10,0 m/s ²	7,5 m/s ²	7,5 m/s ²	6,0 m/s ²	6,0 m/s ²	9,1 m/s ²	9,1 m/s ²
Stofafzuigingsunit		DX16: optioneel	DX15: optioneel	DX15: optioneel	DX14: optioneel	DX14: inbegrepen	DX11: inbegrepen	DX11: inbegrepen
AWS		✓ (excl. Bluetooth unit)	✓ (excl. Bluetooth unit)	✓ (excl. Bluetooth unit)	✓	✓	✓ (excl. Bluetooth unit)	✓ (excl. Bluetooth unit)
Gewicht		2,9 - 4,5 kg	3,8 - 4,8 kg	3,8 - 4,8 kg	4,1 - 4,6 kg	4,1 - 4,6 kg	5,3 - 6,7 kg	5,3 - 6,7 kg
Prijs in €	excl. btw	€ 299,00	€ 359,00	€ 825,00	€ 479,00	€ 1.095,00	€ 649,00	€ 1.115,00
	incl. btw	€ 361,79	€ 434,39	€ 998,25	€ 579,59	€ 1.324,95	€ 785,29	€ 1.349,15

AFT Active feedback sensing technology

Deze technologie schakelt de motor onmiddellijk uit bij het plots blokkeren van de machine. Sommige machines maken daarbij gebruik van een accelerometer die de zwenkbeweging van de machine detecteert. De AFT-technologie verhoogt de veiligheid enorm.



HR005G

- Uitstekende vermogen/gewichtsverhouding
- Beveiliging tegen terugslag (AFT met accelerometer)
- Actieve trillingsdemping (AVT)

Slagenergie
8,0 J



HR005GM202

HR006G

- 2 x 40Vmax accu's in serie zorgen voor extreme kracht
- Beveiliging tegen terugslag (AFT met accelerometer)
- Actieve trillingsdemping (AVT)



Slagenergie
20,0 J

HR006GZ

	HR005GZ01	HR005GM202	HR006GZ
Spanning	36 V (40 Vmax)	36 V (40 Vmax)	2 x 36 V (40 Vmax)
Bijgeleverde Accu's	-	2 x BL4040	-
Slagenergie	8,0 J	8,0 J	20,0 J
Slagfrequentie	1450 - 2900 min ⁻¹	1450 - 2900 min ⁻¹	1100 - 2250 min ⁻¹
Trillingsniveau (ah)	5 m/s ²	5 m/s ²	8,5 m/s ²
Capaciteit beton	40 mm	40 mm	52 mm
Toerental onbelast	250 - 500 min ⁻¹	250 - 500 min ⁻¹	250 - 310 min ⁻¹
AFT	✓	✓	✓
AWS	✓	✓	✓ (excl. Bluetooth unit)
Gewicht	7,4 kg - 8,2 kg	7,4 kg - 8,2 kg	12,9 - 14,3 kg
Prijs in €	excl. btw	€ 845,00	€ 1.309,00
	incl. btw	€ 1.022,45	€ 1.583,89

NEXT GENERATION TECHNOLOGY

ACCU BREEKHAMERS SDS-MAX

BL
MOTOR

XGT
40V^{Li-ion}
max

XGT
80V^{max}

HM001G



- Evenaart de kracht van modellen op netstroom
- Hoge slagenergie (9,4 J)
- Uitzonderlijk laag trillingsniveau dankzij actieve trillingsdemping (AVT) en een anti-vibratie behuizing



HM001GM205

Slagenergie
9,4 J



HM002GZ03

Slagenergie
20,0 J

HM002G



- Extreem krachtig dankzij twee 40Vmax accu's in serie
- Zeer hoge slagenergie (20 J)
- Uitzonderlijk laag trillingsniveau dankzij actieve trillingsdemping (AVT) en een anti-vibratie behuizing

	HM001GZ04	HM001GM205	HM002GZ03
Spanning	36 V (40Vmax)	36 V (40Vmax)	2 x 36 V (40Vmax)
Bijgeleverde accu's	-	2 x BL4040	-
Bijgeleverde lader	-	DC40RA	-
Slagenergie	9,4 J	9,4 J	20 J
Slagfrequentie	0 - 2650 min ⁻¹	0 - 2650 min ⁻¹	950 - 1900 min ⁻¹
Triax. vibratie beitelten (ah)	6,0 m/s ²	6,0 m/s ²	8,0 m/s ²
AWS	✓	✓	✓ excl. Bluetooth unit
Gewicht	6,3 - 7,1 kg	6,3 - 7,1 kg	12,0 - 13,3 kg
Prijs in €	excl. btw	€ 535,00	€ 995,00
	incl. btw	€ 647,35	€ 1.203,95
		€ 775,00	€ 937,75



ACCU HAAKSE SLIJPERS 125 MM X-LOCK



Snel en veilig schijven bevestigen via een kliksysteem.



GA044GM201



191G05-4
STOFAFZUIGKAP X-LOCK
€ 101,20 excl. btw
€ 122,45 incl. btw

	GA041GZ	GA041GM201	GA044GZ	GA044GM201	GA047GZ	GA047GM201	
Spanning	36 V (40Vmax)	36 V (40Vmax)	36 V (40Vmax)	36 V (40Vmax)	36 V (40Vmax)	36 V (40Vmax)	
Bijgeleverde accu's	-	2x BL4040	-	2x BL4040	-	2x BL4040	
Bijgeleverde lader	-	DC40RA	-	DC40RA	-	DC40RA	
Schijfdiameter	125 mm	125 mm	125 mm	125 mm	125 mm	125 mm	
Toerental onbelast	3,000 - 8,500 min ⁻¹	3,000 - 8,500 min ⁻¹	3,000 - 8,500 min ⁻¹	3,000 - 8,500 min ⁻¹	8,500 min ⁻¹	8,500 min ⁻¹	
Slijpdiepte	31 mm	31 mm	31 mm	31 mm	31 mm	31 mm	
Type schakelaar	Schuifschakelaar	Schuifschakelaar	Lepelschakelaar	Lepelschakelaar	Lepelschakelaar	Lepelschakelaar	
Dodemansschakelaar	-	-	✓	✓	✓	✓	
AWS	✓	✓	✓	✓	-	-	
Verpakking	-	Makpac	-	Makpac	-	Makpac	
Gewicht	3.0 - 5.3 kg	3.0 - 5.3 kg	3.0 - 5.3 kg	3.0 - 5.3 kg	3.0 - 5.3 kg	3.0 - 5.3 kg	
Prijs in €	excl. btw	€ 299,00	€ 785,00	€ 309,00	€ 795,00	€ 285,00	€ 775,00
	incl. btw	€ 361,79	€ 949,85	€ 373,89	€ 961,95	€ 344,85	€ 937,75

NEXT GENERATION TECHNOLOGY

ACCU HAAKSE SLIJPERS 125 MM



GA050G

- Compact, zeer hoog vermogen en hoog toerental
- Speciale motorbehuizing in één stuk en trillings-absorberende rubbers tussen de binnen- en buitenkant
- Vernieuwd ontwerp met kleine greepomtrek

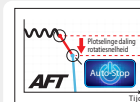

Active Feedback sensing Technology
Schakelt de motor uit bij het plots blokkeren van de schijf

STOFAFZUIGING VOOR SLIJPERS



191F81-2
€ 55,80 excl. btw
€ 67,52 incl. btw



191G06-2
€ 101,20 excl. btw
€ 122,45 incl. btw

Gereedschapsloze beschermkap

- Er is geen gereedschap nodig om de kap te monteren of te verwijderen.
- De beschermkap kan via een kliksysteem in de gewenste stand geplaatst worden.

	GA005GZ01	GA005GM201	GA013GZ01	GA013GM201	GA050GZ	GA023GZ	GA023GM201	GA029GZ	GA029GM201
Spanning	36 V (40Vmax)	36 V (40Vmax)	36 V (40Vmax)	36 V (40Vmax)	36 V (40Vmax)	36 V (40Vmax)	36 V (40Vmax)	36 V (40Vmax)	36 V (40Vmax)
Bijgeleverde accu's	0	2 x BL4040	0	2 x BL4040	-	0	2 x BL4040	0	2 x BL4040
Bijgeleverde lader	-	DC40RA	-	DC40RA	-	-	DC40RA	-	DC40RA
Toerental onbelast	8500 t.p.m.	8500 t.p.m.	8500 t.p.m.	8500 t.p.m.	11000 t.p.m.	3000 - 8500 t.p.m.	3000 - 8500 t.p.m.	3000 - 8500 t.p.m.	3000 - 8500 t.p.m.
Regelbaar toerental	-	-	-	-	-	✓	✓	✓	✓
Type schakelaar	Schuifschakelaar met vergrendeling	Schuifschakelaar met vergrendeling	Lepelschakelaar zonder vergrendeling	Lepelschakelaar zonder vergrendeling	Lepelschakelaar zonder vergrendeling	Schuifschakelaar met vergrendeling	Schuifschakelaar met vergrendeling	Lepelschakelaar zonder vergrendeling	Lepelschakelaar zonder vergrendeling
AWS	-	-	-	-	-	✓	✓	✓	✓
Verpakking	Makpac	Makpac	Makpac	Makpac	-	-	Makpac	-	Makpac
Gewicht	3,0 kg	3,0 kg	3,0 kg	3,0 kg	3,0 kg	3,0 kg	3,0 kg	3,0 kg	3,0 kg
Prijs in €	excl. btw	€ 245,00	€ 699,00	€ 255,00	€ 715,00	€ 275,00	€ 245,00	€ 725,00	€ 255,00
	incl. btw	€ 296,45	€ 845,79	€ 308,55	€ 865,15	€ 332,75	€ 296,45	€ 877,25	€ 308,55

ACCU HAAKSE SLIJPERS 150 MM / 180 MM / 230 MM



Compacte afmetingen en kleine omtrek van de handgreep



	GA035GZ	GA036GZ	GA037GZ01	GA037GM201	GA037GT201	GA038GZ01	GA038GM201	GA038GT201
Spanning	36 V (40Vmax)	36 V (40Vmax)	36 V (40Vmax)	36 V (40Vmax)	36 V (40Vmax)	36 V (40Vmax)	36 V (40Vmax)	36 V (40Vmax)
Bijgeleverde accu's	-	-	-	2 x BL4040	2 x BL4050F	-	2 x BL4040	2 x BL4050F
Bijgeleverde lader	-	-	-	DC40RA	DC40RA	-	DC40RA	DC40RA
Schijfdiameter	150 mm	150 mm	180 mm	180 mm	180 mm	230 mm	230 mm	230 mm
Toerental onbelast	8500 min ⁻¹	8500 min ⁻¹	7800 min ⁻¹	7800 min ⁻¹	7800 min ⁻¹	6600 min ⁻¹	6600 min ⁻¹	6600 min ⁻¹
Slijpdiepte	46 mm	46 mm	68 mm	68 mm	68 mm	73 mm	73 mm	73 mm
Type schakelaar	Schuifschakelaar met vergrendeling	Lepelschakelaar zonder vergrendeling	Lepelschakelaar zonder vergrendeling	Lepelschakelaar zonder vergrendeling	Lepelschakelaar zonder vergrendeling	Lepelschakelaar zonder vergrendeling	Lepelschakelaar zonder vergrendeling	Lepelschakelaar zonder vergrendeling
AWS	-	-	excl. Bluetooth unit	excl. Bluetooth unit	excl. Bluetooth unit	excl. Bluetooth unit	excl. Bluetooth unit	excl. Bluetooth unit
Verpakking	-	-	Koffer	Koffer	Koffer	Koffer	Koffer	Koffer
Gewicht	3,0 - 3,7 kg	3,0 - 3,7 kg	4,4 - 5,4 kg	4,4 - 5,4 kg	4,4 - 5,4 kg	4,6 - 7,4 kg	4,6 - 7,4 kg	4,6 - 7,4 kg
Prijs in €	excl. btw	€ 219,00	€ 229,00	€ 315,00	€ 779,00	€ 845,00	€ 315,00	€ 779,00
	incl. btw	€ 264,99	€ 277,09	€ 381,15	€ 942,59	€ 1.022,45	€ 381,15	€ 942,59

CE001G

- Uiterst krachtig dankzij 2x 40Vmax technologie
- Met soft start, AFT en elektrische rem
- Geïntegreerde watertoevoer
- XPT en Wetguard (IPX4) bescherming
- De combinatie van AVT technologie en een trillingsabsorberende behuizing zorgen voor een zeer laag vibratieniveau.



CE002GZ01

CE002G

- Versie zonder wateraansluiting, ontworpen voor droog zagen
- Met AWS & stofzuigaansluiting
- Incl. diamantschijf



CE001GZ

Promo: gratis
diamantschijf
355 mm E-12996
bij CE001GZ



	CE001GZ	CE002GZ01
Spanning	72 V (80Vmax)	72 V (80Vmax)
Bijgeleverde accu's/lader	-	-
Ø zaagblad	355 mm	355 mm
Toerental onbelast	5300 min ⁻¹	4200 min ⁻¹
Max. zaagdiepte	127 mm	127 mm
Trillingsniveau (ah) vooraan / achteraan	2,5 m/s ² / 1,8 m/s ²	2,5 m/s ² / 1,8 m/s ²
AWS	-	✓
Gewicht	12,3 - 14,1 kg	13,1 - 15,1 kg
Prijs in €	excl. btw	€ 1.099,00
	incl. btw	€ 1.329,79
		€ 1.219,00
		€ 1.474,99

DIAMANTSCHIJVEN

	Artikel	Ø	Dikte	Hoogte segment	Ø asgat	Reductiering	Prijs excl. btw	Prijs incl. btw
Quasar	B-17588	300 mm	3,0 mm	12 mm	25,4 mm	20 mm	€ 223,80	€ 270,80
	B-13465	350 mm	3,0 mm	12 mm	25,4 mm	20 mm	€ 294,40	€ 356,22
	B-13471	400 mm	3,0 mm	12 mm	25,4 mm	20 mm	€ 341,90	€ 413,70
Comet	B-17619	300 mm	3,0 mm	10 mm	25,4 mm	20 mm	€ 184,10	€ 222,76
	B-13552	350 mm	3,0 mm	10 mm	25,4 mm	20 mm	€ 219,30	€ 265,35
	B-13568	400 mm	3,0 mm	10 mm	25,4 mm	20 mm	€ 267,00	€ 323,07
Asfalt	B-13275	350 mm	3,2 mm	10 mm	25,4 mm	20 mm	€ 247,70	€ 299,72
	B-42905	400 mm	3,2 mm	10 mm	25,4 mm	20 mm	€ 330,60	€ 400,03
	Artikel	Ø extern	Ø intern	Dikte	Prijs excl. btw	Prijs incl. btw		
Reductieringen	257199-4	22,23 mm	20,00 mm	3,0 mm	€ 4,60	€ 5,57		
	197318-9	25,4 mm	20,00 mm	5 mm	€ 8,40	€ 10,16		

NEXT GENERATION TECHNOLOGY

ACCU METAALCIRKELZAAG 185 MM



CS002GZ

- Grote snijcapaciteit dankzij de compacte tandwieloverbrenging
- Compartiment in aluminium voor het opvangen van metaalsnippers
- De AFT functie schakelt de motor onmiddellijk uit wanneer het zaagblad blokkeert

		CS002GZ
Spanning		36 V (40Vmax)
Bijgeleverde accu's/lader		-
Ø zaagblad		185 mm
Toerental onbelast		3500 min ⁻¹
Max. zaagdiepte		67 mm
Trillingsniveau (ah)		2,5 m/s ²
Gewicht		4,2 - 5,4 kg
Prijs in €	excl. btw	€ 509,00
	incl. btw	€ 615,89

ACCU MENGERS



- Zeer krachtig, ook geschikt voor het mengen van zwaardere materialen
- Mechanische overbrenging met 2 snelheden
- Duimwieletje voor het instellen van het maximaal toerental, variabel toerental regeling, aan-vergrendelknop en uit-vergrendelknop, softstart
- Inschroefbare ashouder met adapter M12 + M14 binnendraad
- Uitstekende bescherming van schakelaar en accu

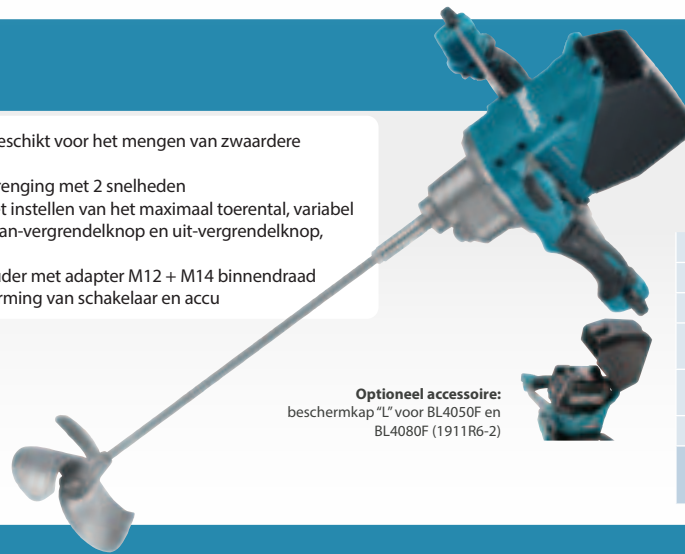

Optioneel accessoire:
beschermkap *L* voor BL4050F en BL4080F (1911R6-2)

		UT001GZ02
Spanning		36V (40Vmax)
Bijgeleverde accu's		-
Bijgeleverde lader		-
Toerental onbelast		0- 500min ⁻¹ 0- 920min ⁻¹
Aansluiting		1/2" - 20 UNF Male Adapter M12 & M14
Gewicht		5,7-7,0 kg
Prijs in €	excl. btw	€ 549,00
	incl. btw	€ 664,29

ACCU BETONTRILNAALDEN



VR001GZ



VR003G



ACCESSOIRES

Artikel	Diameter	Lengte	Prijs excl. btw	Prijs incl. btw
1910E1-5	32 mm	1,2 m	€ 305,00	€ 369,05
1910E2-3	32 mm	1,7 m	€ 335,60	€ 406,08
1910C2-9	32 mm	2,4 m	€ 366,20	€ 443,10
1910E3-1	38 mm	1,2 m	€ 335,60	€ 406,08
1910C4-5	38 mm	2,4 m	€ 386,60	€ 467,79



	VR001GZ	VR003GZ	VR003GM101	VR004GZ	VR004GM101
Spanning	36 v (40Vmax)	36 v (40Vmax)	36 v (40Vmax)	36 v (40Vmax)	36 v (40Vmax)
Bijgeleverde accu's	-	-	1x BL4040	-	1x BL4040
Bijgeleverde lader	-	-	DC40RA	-	DC40RA
Ø trilflæs	-(enkel motor)	32 mm	32 mm	38 mm	38 mm
Lengte naald	-(enkel motor)	1,2 m	1,2 m	1,2 m	1,2 m
Trillingsfrequentie	12000-15000 min ⁻¹	12000-15000 min ⁻¹	12000-15000 min ⁻¹	12000-15000 min ⁻¹	12000-15000 min ⁻¹
Gewicht	4,8 - 7,8 kg	4,8 - 7,8 kg	4,8 - 7,8 kg	4,8 - 7,8 kg	4,8 - 7,8 kg
Prijs in €	excl. btw	€ 259,00	€ 549,00	€ 829,00	€ 565,00
	incl. btw	€ 313,39	€ 664,29	€ 1.003,09	€ 683,65



JR002GM201



JR002G

- Vermogen vergelijkbaar met model op netstroom
- Met pendelmechanisme (JR002G)
- Zeer laag trillingsniveau dankzij AVT technologie
- Handige bladontgrendelingshendel en verstelbare aanslag
- Ledverlichting



JR001GD201

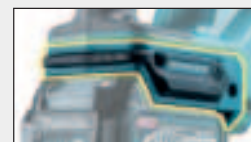

Gedempte ophanging

De accu en de behuizing zijn verbonden met trillingsabsorberende rubbers.

Gereedschapsloze aanpassing van de aanslag

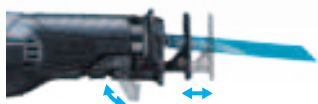

	JR001GZ	JR001GD201	JR001GM201	JR002GZ	JR002GM201	
Spanning	36 V (40Vmax)	36 V (40Vmax)	36 V (40Vmax)	36 V (40Vmax)	36 V (40Vmax)	
Bijgeleverde accu's	0	2 x BL4025	2 x BL4040	-	2 x BL4040	
Bijgeleverde lader	-	DC40RA	DC40RA	-	DC40RA	
Slaglengte	32 mm	32 mm	32 mm	32 mm	32 mm	
Aantal zaagbewegingen	0 - 2300 min ⁻¹ 0 - 3000 min ⁻¹	0 - 2300 min ⁻¹ 0 - 3000 min ⁻¹	0 - 2300 min ⁻¹ 0 - 3000 min ⁻¹	0 - 3000 min ⁻¹ 0 - 3000 min ⁻¹	0 - 3000 min ⁻¹ 0 - 3000 min ⁻¹	
Pendelinstelling	-	-	-	✓	✓	
AVT	-	-	-	✓	✓	
Gewicht	4,2 - 4,5 kg	4,2 - 4,5 kg	4,2 - 4,5 kg	4,6 - 5,8 kg	4,6 - 5,8 kg	
Prijs in €	excl. btw	€ 275,00	€ 655,00	€ 755,00	€ 329,00	€ 815,00
	incl. btw	€ 332,75	€ 792,55	€ 913,55	€ 398,09	€ 986,15



PB002GM201

- Grote zaagcapaciteit tot Ø127 mm
- Variabele snelheidsregeling
- Hoge bandsnelheid
- Gemakkelijke spoorverstelling

	PB002GZ	PB002GM201	
Spanning	36 V (40Vmax)	36 V (40Vmax)	
Bijgeleverde accu's	-	2x BL4040	
Bijgeleverde lader	-	DC40RA	
Zaagcapaciteit	127 x 127 mm	127 x 127 mm	
Zaaglint	1140 x 13 x 0,5 mm	1140 x 13 x 0,5 mm	
Gewicht	6,6 - 7,8 kg	6,6 - 7,8 kg	
Prijs in €	excl. btw	€ 549,00	€ 1.019,00
	incl. btw	€ 664,29	€ 1.232,99



PV001GM101

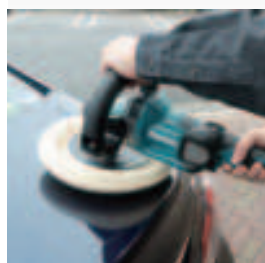

	PV001GZ	PV001GM101	
Spanning	36 V (40Vmax)	36 V (40Vmax)	
Bijgeleverde accu's	-	1x BL4040	
Bijgeleverde lader	-	DC40RA	
Diameter	180 mm	180 mm	
Toerental onbelast	0 - 2200 min ⁻¹	0 - 2200 min ⁻¹	
Gewicht	3,2 - 3,9 kg	3,2 - 3,9 kg	
Prijs in €	excl. btw	€ 349,00	€ 639,00
	incl. btw	€ 422,29	€ 773,19

NEXT GENERATION TECHNOLOGY

ACCU BOVEN- EN KANTENFREES



- Compact en flexibel systeem
- Zeer hoog vermogen dankzij 40Vmax technologie
- Zachte rem
- Verschillende hulpstukken meegeleverd

RT001GM208

		RT001GZ16	RT001GM208
Spanning		36 V (40Vmax)	36 V (40Vmax)
Bijgeleverde accu's		-	2x BL4040
Bijgeleverde lader		-	DC40RA
Toerental onbelast		10000-31000 min ⁻¹	10000-31000 min ⁻¹
Max. induikdiepte		40 mm	40 mm
Ø spantang - bereik		6 - 8 mm	6 - 8 mm
Ø spantang - inbegrepen		6 mm, 8 mm	6 mm, 8 mm
AWS		✓	✓
		excl. Bluetooth unit	excl. Bluetooth unit
Gewicht		2,2 - 2,5 kg	2,2 - 2,5 kg
Prijs in €	excl. btw	€ 439,00	€ 899,00
	incl. btw	€ 531,19	€ 1.087,79

ACCU SCHAAF



- Even krachtig als een machine op netstroom
- Kan tot 4,0 mm in één passage schaven
- Spaanders kunnen links of rechts uitgeworpen worden
- Zool met 3 groeven voor het afschuiven van kanten
- Sponningsdiepte tot 25 mm

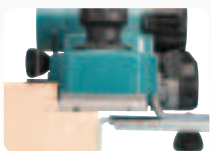

KP001GM202

		KP001GZ01	KP001GM202
Spanning		36 V (40Vmax)	36 V (40Vmax)
Bijgeleverde accu's		-	2x BL4040
Bijgeleverde lader		-	DC40RA
Toerental onbelast		15000 min ⁻¹	15000 min ⁻¹
Schaafbreedte		82 mm	82 mm
Max. spaanafname		40mm	40mm
AWS		✓	✓
Gewicht		3,7 - 4,9 kg	3,7 - 4,9 kg
Prijs in €	excl. btw	€ 349,00	€ 815,00
	incl. btw	€ 422,29	€ 986,15

ACCU INVALCIRKELZAAG



SP001GZ03



AWS compatibel
Voor het draadloos aansturen van een AWS compatibele stofzuiger.
(incl. Bluetooth unit)

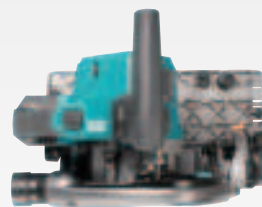

Compact en licht, perfect uitgebalanceerd.
Door het gebruik van slechts één 40Vmax accu en magnesium componenten.



Grote zaagcapaciteit
Zaagdiepte van 56 mm bij 90° en een kantelbereik van -1 tot 48°.



Perfekte geleiding
De magnesium zool past rechtstreeks op een geleiderail.

		SP001GZ03
Spanning		36 V (40Vmax)
Bijgeleverde accu's		-
Ø zaagblad		165 mm
Toerental onbelast		2500 - 4900 min ⁻¹
Zaagdiepte (90°)		56 mm
AWS		✓
Gewicht		4,4 - 5,0 kg
Prijs in €	excl. btw	€ 465,00
	incl. btw	€ 562,65

ACCU DECOUPEERZAGEN

BL
MOTOR

XGT
40V Li-Ion
max

NIEUW



JV001GZ01



JV002GZ

JV001G / JV002G

- 3 pendelinstellingen + recht snijden
- Brede basisplaat voor uitstekende stabiliteit
- De soft-no-load functie verlaagt het toerental bij lage belasting
- JV002G: model met beugelgreep

	JV001GZ01	JV001GM201	JV002GZ	
Spanning	36 V (40Vmax)	36 V (40Vmax)	36 V (40Vmax)	
Bijgeleverde accu's	-	2x BL4040	-	
Bijgeleverde lader	-	DC40RA	-	
Aantal zaagbewegingen	800 - 3500 min ⁻¹	800 - 3500 min ⁻¹	800 - 3500 min ⁻¹	
Max. capaciteit hout	135 mm	135 mm	135 mm	
Slaglengte	26 mm	26 mm	26 mm	
Gewicht	2,6 - 2,9 kg	2,6 - 2,9 kg	2,7 - 3,0 kg	
Verpakking	Makpac	Makpac	Doos	
Prijs in €	excl. btw	€ 299,00	€ 759,00	€ 299,00
	incl. btw	€ 361,79	€ 918,39	€ 361,79

ACCU CIRKELZAGEN

BL
MOTOR

AWS
Auto-start Wireless System

XGT
40V Li-Ion
max

HS012G

- Bijzonder krachtige accucirkelzaag met links geplaatst zaagblad.
- Compact, licht en perfect uitgebalanceerd dankzij de nieuw ontwikkelde BL motor.
- Diepteregeling met duidelijk afleesbare schaal en kantelbaar tot 45°.
- De zool en beschermkap zijn uitgevoerd in hoogwaardig magnesium.
- Opgelet deze machine past niet rechtstreeks op een geleiderail.



HS009GT201



HS012GZ01



HS003GM201



HS011GT201

	HS012GZ01	HS003GZ	HS003GM201	HS004GZ	HS004GZ01	HS004GM202	HS009GZ	HS009GT201	HS010GZ	HS010GT201	HS011GZ	HS011GT201	
Spanning	36 V (40Vmax)	36 V (40Vmax)	36 V (40Vmax)	36 V (40Vmax)	36 V (40Vmax)	36 V (40Vmax)	36 V (40Vmax)	36 V (40Vmax)	36 V (40Vmax)	36 V (40Vmax)	36 V (40Vmax)	36 V (40Vmax)	
Bijgeleverde accu's	-	-	2 x BL4040	-	-	2 x BL4040	-	2x BL4050F	-	2x BL4050F	-	2x BL4050F	
Bijgeleverde lader	-	-	DC40RA	-	-	DC40RA	-	DC40RA	-	DC40RA	-	DC40RA	
Ø zaagblad	165 mm	190 mm	190 mm	190 mm	190 mm	190 mm	235 mm	235 mm	235 mm	235 mm	270 mm	270 mm	
Zaagdiepte (90°)	57 mm	68,5 mm	68,5 mm	62,5 mm	62,5 mm	62,5 mm	85 mm	85 mm	85 mm	85 mm	101 mm	101 mm	
Rechtstreeks op geleiderail	-	-	-	✓	✓	✓	✓	✓	-	-	✓	✓	
AWS	✓	✓	✓	✓	✓	✓	✓	✓	✓	✓	✓	✓	
	excl. Bluetooth unit	excl. Bluetooth unit	excl. Bluetooth unit	excl. Bluetooth unit	✓	✓	excl. Bluetooth unit	excl. Bluetooth unit	excl. Bluetooth unit	excl. Bluetooth unit	excl. Bluetooth unit	excl. Bluetooth unit	
Verpakking	Makpac	-	Makpac	-	-	Makpac	-	Koffer	-	Koffer	-	-	
Gewicht	3,2 - 4,4kg	4,1 - 4,4 kg	4,1 - 4,4 kg	4,4 - 4,7 kg	4,4 - 4,7 kg	4,4 - 4,7 kg	5,1 - 5,7 kg	5,1 - 5,7 kg	6,0 - 6,4 kg	6,0 - 6,4 kg	5,5 - 6,7 kg	5,5 - 6,7 kg	
Prijs in €	excl. btw	€ 349,00	€ 409,00	€ 889,00	€ 459,00	€ 489,00	€ 949,00	€ 475,00	€ 1.029,00	€ 439,00	€ 989,00	€ 525,00	€ 1.075,00
	incl. btw	€ 422,29	€ 494,89	€ 1.075,69	€ 555,39	€ 591,69	€ 1.148,29	€ 574,75	€ 1.245,09	€ 531,19	€ 1.196,69	€ 635,25	€ 1.300,75

NEXT GENERATION TECHNOLOGY

ACCU CIRKELZAGEN MET ACHTERHANDGREEP



RS001GM101

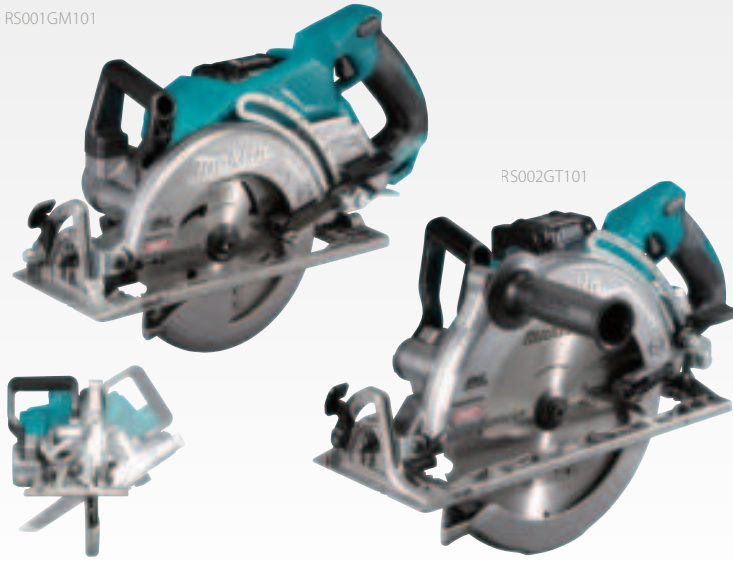

RS002GT101

RS001G / RS002G

- Speciaal ontwerp met handgreep achteraan
- Krachtig en licht (magnesium zool)



	RS001GZ	RS001GM101	RS002GZ	RS002GT101	
Spanning	36 V (40Vmax)	36 V (40Vmax)	36 V (40Vmax)	36 V (40Vmax)	
Bijgeleverde accu's	0	1 x BL4040	0	1 x BL4050F	
Zaagdiepte (90°)	65 mm	65 mm	95 mm	95 mm	
Ø zaagblad	185 mm	185 mm	260 mm	260 mm	
AWS	-	-	✓ excl. Bluetooth unit	✓ excl. Bluetooth unit	
Toerental onbelast	6400 min ⁻¹	6400 min ⁻¹	4000 min ⁻¹	4000 min ⁻¹	
Gewicht	5,0 - 5,6 kg	5,0 - 5,6 kg	5,7 - 6,3 kg	5,7 - 6,3 kg	
Prijs in €	excl. btw	€ 315,00	€ 599,00	€ 465,00	€ 779,00
	incl. btw	€ 381,15	€ 724,79	€ 562,65	€ 942,59

ACCU TELESCOPISCHE AFKORT - VERSTEKZAGEN



Belangrijke bedieningsknoppen zijn vooraan geplaatst



LS002GZ01

Promo:
gratis onderstel
DEBWS06
t.w.v. € 259



Uitschuifbare zijsteunen



Efficiënte stofafzuiging

De geoptimaliseerde stofafzuiging met twee poorten garandeert een perfecte stofafzuiging, ook bij het zagen van dunne planken.



LS003GZ01

Kantelhoek 48°
links en rechts



Aanduiding van de zaaglijn

Een led lamp werpt de schaduw van het zaagblad op het werkstuk, deze aanduiding is onder alle omstandigheden exact.

DXT

Deep and Exact Cutting Technology

De gepatenteerde constructie met driedubbele tandwieloverbrenging en uitsparing achter de flens laat toe om een groter deel van het zaagblad te benutten. Daardoor kunnen ook hoge plinten verticaal of in verstek afgekort worden.



Manuele bediening

De afzuiging kan via een schakelaar ook manueel gestart worden (via Bluetooth), dit is ook handig om de machine schoon te maken.

	LS002GZ01	LS004GZ01	LS003GZ01	
Spanning	36 V (40Vmax)	36 V (40Vmax)	36 V (40Vmax)	
Bijgeleverde accu's	0	0	0	
Ø zaagblad	216 mm	260 mm	305 mm	
Verstekhoek	60 L / 60 R	60° L / 60° R	60 L / 60 R	
Kantelhoek	48° L / 48° R	48° L / 48° R	48° L / 48° R	
Toerental onbelast	4800 min ⁻¹	3600 min ⁻¹	3600 min ⁻¹	
Capaciteit	70 x 312 mm	91 x 312 mm	107 x 312 mm	
AWS	✓	✓	✓	
DXT	✓	✓	✓	
Gewicht	16,4 - 17,0 kg	26,6 - 27,2 kg	30,5 - 31,1 kg	
Prijs in €	excl. btw	€ 755,00	€ 899,00	€ 1.099,00
	incl. btw	€ 913,55	€ 1.087,79	€ 1.329,79

COMBOPACK XGT



Promo: gratis
extra accu 2,5 Ah

DK0114G201

Bijgeleverde accu's	2 x BL4040
Bijgeleverde lader	DC40RA
Laadadapter	ADP10
Klopboor- en schroef- machine	HP001G
Slagschroevendraaier	TD001G
Verpakking	Gereedschapstas
Prijs in €	excl. btw € 919,00 incl. btw € 1.111,99

COMBOPACK XGT



Promo: gratis
extra accu 2,5 Ah

DK0124G201

Bijgeleverde accu's	2 x BL4040
Bijgeleverde lader	DC40RA
Boor- en schroefmachine	DF001G
Haakse slijper 125 mm	GA005G
Verpakking	Makpac
Prijs in €	excl. btw € 839,00 incl. btw € 1.015,19

COMBOPACK XGT



Promo: gratis
extra accu 4,0 Ah

DK0125G301

Bijgeleverde accu's	2 x BL4040
Bijgeleverde lader	DC40RA
Boor- en schroefmachine	DF001G
Slagschroevendraaier	TD001G
Haakse slijper 125 mm	GA005G
Verpakking	Makpac
Prijs in €	excl. btw € 1.099,00 incl. btw € 1.329,99

NEXT GENERATION TECHNOLOGY

COMBOPACK XGT

XGT
40V Li-ion
max

Promo: gratis extra
accu 4,0 Ah + extra
lader DC40RA



DK0126G401

Bijgeleverde accu's	2 x BL4040	
Bijgeleverde lader	DC40RA	
Haakse slijper 125 mm	GA005G	
Reciprozaag	JR001G	
Boor- en schroefmachine	DF001G	
Slagschroevendraaier	TD001G	
Verpakking	Gereedschapstas	
Prijs in €	excl. btw	€ 1.309,00
	incl. btw	€ 1.583,89

COMBOPACK XGT

XGT
40V Li-ion
max



Promo: gratis
Powerpack 4,0 Ah
t.w.v. € 549

DK0128G601

Bijgeleverde accu's	2 x BL4040	
Bijgeleverde lader	DC40RA	
Boor- en schroefmachine	DF001G	
Slagschroevendraaier	TD001G	
Haakse slijper 125 mm	GA005G	
Reciprozaag	JR001G	
SDS plus combihamer	HR002G	
Cirkelzaag 190 mm	HS003G	
Verpakking	Gereedschapstas	
Prijs in €	excl. btw	€ 2.219,00
	incl. btw	€ 2.684,99

Prijzen geldig t.e.m. 31/12/2023

1. CHOOSE YOUR BODY!

2. CHOOSE YOUR POWER!

3. MIX IT UP!



191L29-0

Li-ion accu BL4020
40Vmax • 2,0 Ah • 0,69 kg • 22 min*



€ 135,00 excl. btw
€ 163,35 incl. btw

191B36-3

Li-ion accu BL4025
40Vmax • 2,5 Ah • 0,71 kg • 28 min*



€ 149,00 excl. btw
€ 180,29 incl. btw

191B26-6

Li-ion accu BL4040
40Vmax • 4,0 Ah • 1,0 kg • 45 min*



€ 209,00 excl. btw
€ 252,89 incl. btw

1910N6-8

Li-ion accu BL4040F
40Vmax • 4,0 Ah • 1,0 kg • 45 min*



€ 245,00 excl. btw
€ 296,45 incl. btw

191L47-8

Li-ion accu BL4050F
40Vmax • 5,0 Ah • 1,3 kg • 50 min*



€ 249,00 excl. btw
€ 301,29 incl. btw

191X65-8

Li-ion accu BL4080F
40Vmax • 8,0 Ah • 2,0 kg • 80 min*



€ 345,00 excl. btw
€ 417,45 incl. btw

191J81-6

XGT Powerpack 2,5 Ah



€ 395,00 excl. btw
€ 477,95 incl. btw

191J65-4

XGT Powerpack 4,0 Ah



€ 299,00 excl. btw
€ 361,79 incl. btw

191L77-9

XGT Powerpack 4,0 Ah



€ 369,00 excl. btw
€ 446,49 incl. btw

1911V6-0

XGT Powerpack 5,0 Ah



€ 439,00 excl. btw
€ 531,19 incl. btw

191U00-8

XGT Powerpack 4,0 Ah



€ 599,00 excl. btw
€ 724,79 incl. btw

191U28-6

XGT Powerpack 4,0 Ah



€ 979,00 excl. btw
€ 1.184,59 incl. btw

191U13-9

XGT Powerpack 5,0 Ah



€ 669,00 excl. btw
€ 809,49 incl. btw

191U42-2

XGT Powerpack 5,0 Ah



€ 1.109,00 excl. btw
€ 1.341,89 incl. btw

191Y97-1

XGT Powerpack 8,0 Ah



€ 839,00 excl. btw
€ 1.015,19 incl. btw

DEAADP001G

ADP001 Laadadapter

USB-adapter voor XGT 40Vmax accu's



€ 51,80 excl. btw
€ 62,68 incl. btw

191E07-8

Oplader DC40RA

Snellader voor XGT 40Vmax accu's

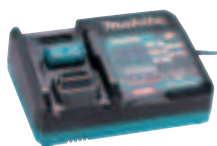

€ 125,00 excl. btw
€ 151,25 incl. btw

191N09-8

Duo snellader DC40RB

Duo snellader voor het gelijktijdig laden van twee XGT 40Vmax accu's



€ 219,00 excl. btw
€ 264,99 incl. btw

191C10-7

ADP10 Laadadapter

Adapter om LXT 14,4 V en 18 V accu's te laden op een XGT 40Vmax lader



€ 60,70 excl. btw
€ 73,45 incl. btw

1911L9-4

Duo oplader DC40WA

Traaglader voor XGT 40Vmax accu's



€ 129,90 excl. btw
€ 157,18 incl. btw

1910D9-2

Communicatieadapter ADP12

Adapter om XGT-machines te verbinden met smartphone, laptop,...

* de adapter wordt enkel tussen machine en accu geplaatst tijdens controle / bij het maken van de gewenste instellingen



€ 152,00 excl. btw
€ 183,92 incl. btw

- Diefstalbeveiliging instellen d.m.v. een pincode
- De werkingsduur van accu's instellen
- De gebruikshistoriek van de XGT-machines raadplegen

BL4040F

GEAVANCEERDE "HIGH PERFORMANCE" ACCU



De nieuwe geavanceerde BL4040F accu is uiterst krachtig en tegelijkertijd ook compact en licht.

- Hoger vermogen, in de praktijk betekent dit bijvoorbeeld dat het toerental van de machine minder zal terugvallen bij zware belasting.
- Minder opwarming, en in extreme situaties dus ook minder kans op uitval door oververhitting.
- Een betere autonomie omdat het energieverlies kleiner is. Je kan dus langer werken op één acculading.



De BL4040F heeft een bijzonder lage interne weerstand dankzij het gebruik van Li-ion cellen met een unieke chemische samenstelling.

NIEUW

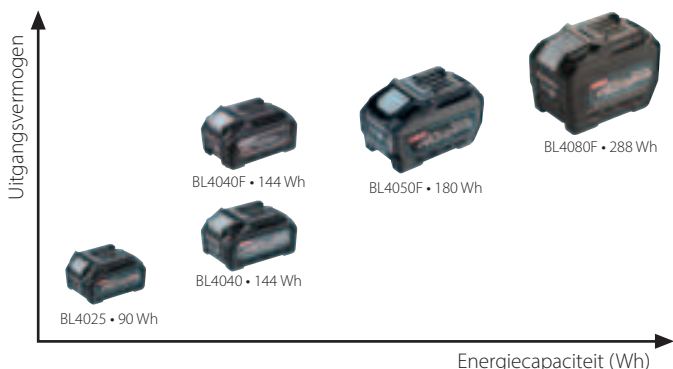

SPECIFIEKE TOEPASSINGEN

De BL4040F is een uitstekende keuze wanneer een hoog piekvermogen vereist is en de batterij tegelijkertijd ook zo licht en compact mogelijk moet zijn. Enkele voorbeelden zijn haakse slijpers, boorhamers, cirkelzagen, en (tophandle) kettingzagen.

- ✓ HOOG VERMOGEN
- ✓ LICHT EN COMPACT
- ✓ BETERE AUTONOMIE
- ✓ MINDER OPWARMING

- De BL4040 en BL4040F hebben dezelfde compacte afmetingen en wegen exact even veel.
- Het piekvermogen van de BL4040F benadert dat van de grotere BL4050F.
- De energiec capaciteit van de BL4040 als BL4040F is hetzelfde (144 Wh), maar in praktijk echter blijkt de autonomie van de BL4040F groter omdat het energieverlies bij het ontladen kleiner is.
- De energiec capaciteit van de BL4050F is nog steeds groter, maar deze accu is ook groter en zwaarder dan de BL4040F.

	NIEUW			
	BL4040	BL4040F	BL4050F	
Referentie	191B-26-6	1910N6-8	191L47-8	
Energiecapaciteit	144 Wh	144 Wh	180 Wh	
Piekvermogen *	1,5 kW	2,1 kW	2,2 kW	
Gewicht	1,0 kg	1,0 kg	1,4 kg	
Prijs in €	excl. btw	€ 209,00	€ 245,00	€ 249,00
	incl. btw	€ 252,89	€ 296,45	€ 301,29

* Het maximum vermogen dat gedurende 3 s geleverd kan worden



ACCU MINIBRADPISTOOL 18 GA



FN001GZ02

	FN001GZ02	FN001GA202
Spanning	36 V (40Vmax)	36 V (40Vmax)
Bijgeleverde accu's	-	2x BL4020
Bijgeleverde lader	-	DC40RA
Lengte nagels	15 - 40 mm	15 - 40 mm
Capaciteit magazijn	100	100
Makpac	✓	✓
Gewicht	2.6 - 3.2 kg	2.6 - 3.2 kg
Prijs in €	excl. btw	€ 445,00
	incl. btw	€ 538,45
Prijs in €	excl. btw	€ 779,00
	incl. btw	€ 942,59

ACCU PINPISTOOL 23 GA



PT001GZ01

- Werkt sneller dankzij BL motor en herontworpen indrijvingsveer
- Mechanisme met bewegend tegengewicht voor lage terugslag

	PT001GZ01	PT001GD101
Spanning	36 V (40Vmax)	36 V (40Vmax)
Bijgeleverde accu's	-	1x BL4025
Bijgeleverde lader	-	DC40RA
Lengte nagels	15 - 35 mm	15 - 35 mm
Capaciteit magazijn	120	120
Makpac	✓	✓
Gewicht	2.4 - 3.0 kg	2.4 - 3.0 kg
Prijs in €	excl. btw	€ 445,00
	incl. btw	€ 538,45
Prijs in €	excl. btw	€ 679,00
	incl. btw	€ 821,59

ACCU COMPRESSOR



- Compact en lichtgewicht ontwerp, ideaal voor binnentoepassingen zoals nieten en spijkeren
- Olievrije pomp met hoog luchtdebiet
- Manometer voor zowel tank- als uitgangsdruk
- Laag geluidsniveau
- Stevig metalen frame beschermt de motor en compressor en vergemakkelijkt het transport

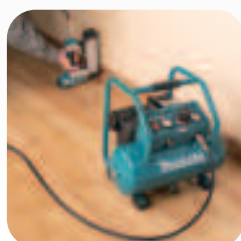

AC001GZ

Spanning	36V (40Vmax)	
Bijgeleverde accu's	-	
Debiet	34 l/min @ 6,0 bar	
Inschakeldruk	7,2 bar	
Uitschakeldruk	9,4 bar	
Uitgangsdruk	0 - 9,3 bar	
Geluidsdrukkniveau	68 dB(A)	
Tankinhoud	7,6 L	
Gewicht	10,1 - 12,8 kg	
Prijs in €	excl. btw	€ 449,00
	incl. btw	€ 543,29

XGT

40V Li-ion max

Hoog vermogen

Robuust

**Digitale
communicatie**



XGT

40V Li-ion max

XGT X2
80V max



Accu

BL4020
2.0Ah

BL4025 /
BL4025F
2.5Ah

BL4040 /
BL4040F
4.0Ah



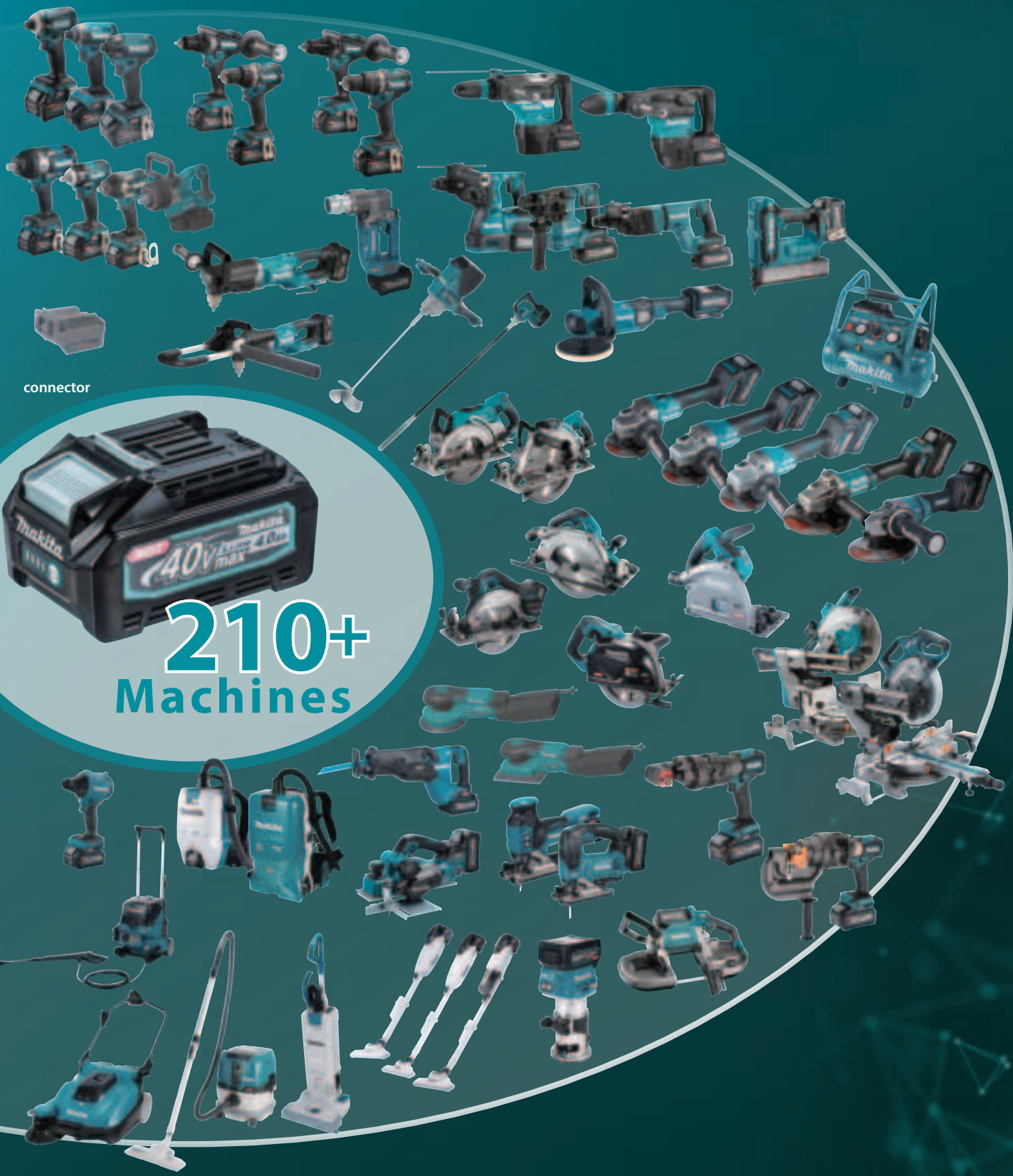

connector



210+
Machines

Lader

BL4050F
5.0Ah

BL4080F
8.0Ah

DC40RA

DC40RB

DC40WA

DC40RC

ADP10



Adapter voor
LXT Batterij

LXT-Platform

Betrouwbaar – veelzijdig – krachtig

Snel en optimaal laden

Wanneer de batterijen warm zijn, dan is het belangrijk dat die eerst gekoeld worden vooraleer het laadtraject te starten. De lader is uitgerust met een ventilator die de batterijen koelt vóór en tijdens het laden om de laadtijd te verkorten.

Makita geavanceerd laadsysteem
Geforceerde koeling



Snelladen



Standaard laadsysteem
Natuurlijke warmteafvoer



Langere laadtijd



3.0Ah
Li-ion

22 minuten

3,0 Ah
BL1830B

SNELSTE LAADTIJD

4.0Ah
Li-ion

36 minuten

4,0 Ah
BL1840B

5.0Ah
Li-ion

45 minuten

5,0 Ah
BL1850B

6.0Ah
Li-ion

55 minuten

6,0 Ah
BL1860B

LANGSTE WERKDUUR





18V
LITHIUM-ION

18V + 18V →

36V

LXT

Met de uitgebreide LXT-serie biedt Makita een accu voor meer dan 420 machines en tuingereedschap dat werkt op 18 V en 2 x 18 V. Het voortdurend groeiende LXT-platform biedt professionele oplossingen voor elke klus

197280-8

accu BL1850B 18V 5,0 Ah



€ 109,00 excl. btw
€ 131,89 incl. btw

197288-2

TWINPACK 18V 2 x 5,0 Ah



€ 209,00 excl. btw
€ 252,89 incl. btw

197422-4

accu BL1860B 18V 6,0 Ah



€ 119,00 excl. btw
€ 143,99 incl. btw

DECADP05

USB-adapter

USB-adapter voor 14,4V/18V accu's



€ 35,20 excl. btw
€ 42,59 incl. btw

197494-9

POWERPACK 18V 2 x 4,0 Ah



€ 279,00 excl. btw
€ 337,59 incl. btw

197624-2

POWERPACK 18V 2 x 5,0 Ah



€ 299,00 excl. btw
€ 361,79 incl. btw

197629-2

POWERPACK 18V 2 x 5,0 Ah



€ 349,00 excl. btw
€ 422,29 incl. btw

197626-8

POWERPACK 18V 4 x 5,0 Ah



€ 549,00 excl. btw
€ 664,29 incl. btw

198116-4

Powerpack 18V 2 x 6,0 Ah



€ 329,00 excl. btw
€ 398,09 incl. btw

198077-8

POWERPACK 18V 2 x 6,0 Ah

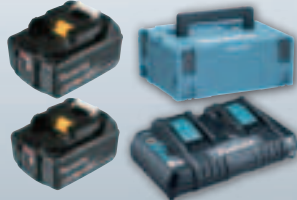

€ 379,00 excl. btw
€ 458,59 incl. btw

198091-4

POWERPACK 18V 4 x 6,0 Ah



€ 579,00 excl. btw
€ 700,59 incl. btw

198170-8

Accu timer LXT BPS01
Programmeert de werkingsduur
van 14,4V & 18V accu's



€ 137,40 excl. btw
€ 166,25 incl. btw

195584-2

OPLADER DC18RC

Snellader voor LXT accu's van 14,4/18V



€ 75,00 excl. btw
€ 90,75 incl. btw

196933-6

DUBBELLADER DC18RD

Duo snellader voor LXT accu's: 14,4/18V



2 accu's BL1850 laden
in 45 minuten
€ 139,00 excl. btw
€ 168,19 incl. btw

198720-9

OPLADER DC18RE

Snellader voor zowel CXT als LXT accu's



€ 129,00 excl. btw
€ 156,09 incl. btw

196426-3

Oplader DC18SF

Traaglader voor LXT accu's, 4 poorten
Laadt twee accu's tegelijk op



€ 199,00 excl. btw
€ 240,79 incl. btw

LXT

CXT



2x 18V

18V

18V LITHIUM-ION

Invalcirkelzaag

Kettingzaag

Hoogsnouier

Grastrimmer

Grasmaaiers

Doorslijper

Snoeischaar

Groenmaaier

Bladblazers

Haagschaar

Hogedrukreiniger

Vacuumpomp

Slagmoersleutels

Cirkelzagen

Haakse slijpers

Stofzuigers

Draagbaar accupack

Waterkoker

Combisysteem

Menger

Boormachine

Slagschroevendraaiers

Schroefmachines

Invalzagen

Ruggedragen stofzuigers

Waterkoker

Staannde stofzuiger

Schroefautomaten

Boormachine

Slagschroevendraaiers

Schroefmachines

Haakse boormachines

Haakse slag-schroevendraaiers

Slagschroevendraaiers

Ratelmoeisleutel

Haakse boormachines

Klopboormachines

Boor- en schroefmachines

Bijhamer

Boorhamers

Combihamers SDS-plus

Stofzuiger

Boven- en kantenfrees

Reciprozagen

Multitool

Betonijzerzaag

Plaatschaar

Knabberschaar

Draadstangknippers

Zaagmachines

Metaalcirkelzagen

Gipszaag

Cirkelzagen

Schuurpolijst-machine

Langnek-schuurmachine

Handpalm-schuurmachines

Polijstmachines

Bandzagen

Bandschuurmachine

Decoupeerzagen

Afkort-verstekzagen

Haakse slijper

Lamellenfrees

ACCU BOOR- EN SCHROEFMACHINE

14.4V
LITHIUM-ION



incl. 59 accessoires

DDF343RYX2

DDF343RYX2

Spanning	14,4 V	
Bijgeleverde accu's	2 x BL1415N	
Hard koppel	36 Nm	
Boorkop	1-10 mm	
Gewicht	1,4 kg	
Prijs in €	excl. btw	€ 289,00
	incl. btw	€ 349,69

ACCU (KLOP-)BOOR- EN SCHROEFMACHINE

18V
LITHIUM-ION



DHP453RFX2

incl. 96 accessoires

DHP453RFX2

Spanning	18 V	
Bijgeleverde accu's	2 x BL1830B	
Hard koppel	42 Nm	
Boorkop	1,5-13 mm	
Gewicht	1,7 kg	
Prijs in €	excl. btw	€ 355,00
	incl. btw	€ 429,55

ACCU (KLOP-)BOOR- EN SCHROEFMACHINES

MAK PAC

18V
LITHIUM-ION



DDF484RT3J



DDF486RT3J

Uitgeleverd met 3 accu's

	DDF453RF3J	DDF482RT3J	DDF484RT3J	DDF486RT3J	DHP486RT3J	
Spanning	18 V	18 V	18 V	18 V	18 V	
Bijgeleverde accu's	3 x BL1830B	3 x BL1850B	3 x BL1850B	3 x BL1850B	3 x BL1850B	
BL-motor	-	-	✓	✓	✓	
Klopboorfunctie	-	-	-	-	✓	
Hard koppel	42 Nm	62 Nm	54 Nm	130 Nm	130 Nm	
Boorkop	1,5-13 mm	1,5-13 mm	1,5-13 mm	1,5 - 13 mm	1,5 - 13 mm	
Gewicht	1,7 kg	1,7 kg	1,5 kg	2,3 - 2,6 kg	2,3 - 2,7 kg	
Prijs in €	excl. btw	€ 325,00	€ 425,00	€ 459,00	€ 539,00	€ 569,00
	incl. btw	€ 393,25	€ 514,25	€ 555,39	€ 652,19	€ 688,49

ACCU (KLOP-)BOOR- EN SCHROEFMACHINES



DDF489/DHP489

- Uiterst krachtige en compacte machine voor all-round gebruik
- Volledig metalen boorkop



	DDF083ZJ	DDF487RAJ	DDF485RTJ
Spanning	18 V	18 V	18 V
Bijgeleverde accu's	-	2 x BL1820	2 x BL1850B
Klopboorfunctie	-	-	-
Hard koppel	40 Nm	40 Nm	50 Nm
Opname	1/4 hex	1,5 - 13 mm	1,5-13 mm
Gewicht	1,1 - 1,4 kg	1,3 - 1,6 kg	1,4 kg
Prijs in €	excl. btw	€ 149,00	€ 325,00
	incl. btw	€ 180,29	€ 393,25

Wist je dat er van DDF484 en DHP486 ook de voordelige uitvoeringen DDF484Z / DDF484T1J en DHP486Z / DHP486T1J bestaan? Zie p. 52 - 53 voor meer info!

	DDF484RTJ	DDF489RTJ	DDF486RTJ	DHP487RAJ	DHP485RFJ	DHP484RTJ	DHP489RTJ	DHP486RTJ
Spanning	18 V	18 V	18 V	18 V	18 V	18 V	18 V	18 V
Bijgeleverde accu's	2 x BL1850B	2 x BL1850B	2 x BL1850B	2 x BL1820	2 x BL1830B	2 x BL1850B	2 x BL1850B	2 x BL1850B
Klopboorfunctie	-	-	-	✓	✓	✓	✓	✓
Hard koppel	54 Nm	73 Nm	130 Nm	40 Nm	50 Nm	54 Nm	73 Nm	130 Nm
Opname	1,5-13 mm	1,5-13 mm	1,5-13 mm	1,5 - 13 mm	1,5-13 mm	1,5-13 mm	1,5 - 13 mm	1,5 - 13 mm
Gewicht	1,6 - 2,2 kg	1,8 - 2,5 kg	2,3 - 2,7 kg	1,3 - 1,6 kg	1,4 - 1,7 kg	1,6 - 2,2 kg	1,8 - 2,5 kg	2,3 - 2,7 kg
Prijs in €	excl. btw	€ 399,00	€ 435,00	€ 465,00	€ 329,00	€ 285,00	€ 409,00	€ 455,00
	incl. btw	€ 482,79	€ 526,35	€ 562,65	€ 398,09	€ 344,85	€ 494,89	€ 550,55

ACCU HAAKSE BOORMACHINES



	DDA350ZJ	DDA351RTJ	DDA450RTE	DDA460ZK
Spanning	18 V	18 V	18 V	2 x 18 V
Bijgeleverde accu's	-	2 x BL1850B	2 x BL1850B	-
Toerental	0-1800 t.p.m.	0-1800 t.p.m.	0 - 450 t.p.m. 0 - 1400 t.p.m.	0-350 t.p.m. 0-1400 t.p.m.
BL motor	-	-	✓	✓
XPT	-	-	✓	✓
Hard koppel	13,7 Nm	13,7 Nm	26/70 Nm	70/136 Nm
Boorkop	1,5-10 mm	1,5-10 mm	1,5-13 mm	1,5-13 mm
Gewicht	1,8 kg	1,8 kg	3,2 kg	5,7 kg
Prijs in €	excl. btw	€ 229,00	€ 475,00	€ 549,00
	incl. btw	€ 277,09	€ 574,75	€ 664,29

ACCU BIKHAMER SDS-PLUS



DHK180RTJ



		DHK180ZJ	DHK180RTJ
Spanning		18V	18V
Bijgeleverde accu's		0	2 x BL1850B
Slagenergie		3,1 J	3,1 J
Slagfrequentie		0 - 3200/min	0 - 3200/min
Triaxiale vibratiewaarde (ah)		4,5 m/s ²	4,5 m/s ²
Gewicht		3,3 kg	3,3 kg
Prijs in €	excl. btw	€ 539,00	€ 775,00
	incl. btw	€ 652,19	€ 937,75

ACCU BOORHAMERS SDS-PLUS



DHR171RTJ



PROMO
Gratis 3e BL1850B bij DHR243RTJ



DHR202RTJ



DHR243RTJ



DHR183RTWJ



DHR182RTWJ

DHR182RTWJ
DHR243RTJW
DHR183RTWJ
incl. STOF AFZUIGING



		DHR171RTJ	DHR183RTWJ	DHR202RTJ	DHR182RTJ	DHR182RTWJ	DHR243RTJ	DHR243RTJW
Spanning		18V	18V	18V	18V	18V	18V	18V
Bijgeleverde accu's		2 x BL1850B	2 x BL1850B	2 x BL1850B	2 x BL1850B	2 x BL1850B	2 x BL1850B	2 x BL1850B
Slagenergie		1,2 J	1,7 J	2 J	1,7 J	1,7 J	2 J	2 J
Max. Ø beton		16 mm	16 mm	20 mm	18 mm	18 mm	24 mm	24 mm
BL-motor		✓	✓	-	✓	✓	✓	✓
AVT		-	✓	-	✓	✓	-	-
AWS		-	-	-	✓ excl. Bluetooth unit	✓ excl. Bluetooth unit	-	-
Stofafzuigstelsysteem		-	DX16	-	-	DX05	-	DX07
Gewicht		2,1 kg	2,1 - 2,8 kg	3,5 kg	2,4 kg	3,3 kg	3,2 kg	4,7 kg
Prijs in €	excl. btw	€ 485,00	€ 539,00	€ 489,00	€ 509,00	€ 529,00	€ 599,00	€ 639,00
	incl. btw	€ 586,85	€ 652,19	€ 591,69	€ 615,89	€ 640,09	€ 724,79	€ 773,19

PROMO

D-42444 bij DHR243T1J en DHR243Z

Wist je dat er van DHR243 ook de voordelige uitvoeringen DHR243Z en DHR243T1J bestaan? Zie p. 60-61 voor meer info!

Technologie

AFT

Active feedback sensing technology

Deze technologie schakelt de motor onmiddellijk uit bij het plots blokkeren van de machine. Sommige machines maken daarbij gebruik van een accelerometer die de zwenkbeweging van de machine detecteert. De AFT-technologie verhoogt de veiligheid enorm.

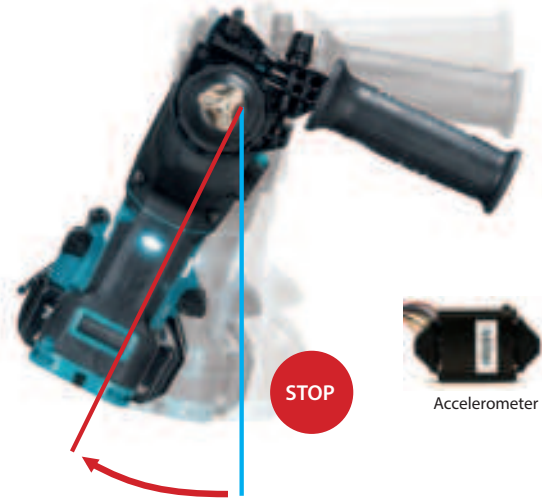
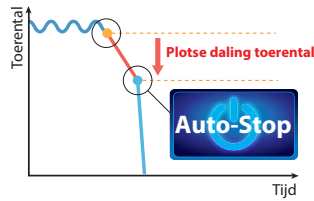

AVT

Anti-vibration technology

Het AVT-systeem reduceert trillingen drastisch door het gebruik van een systeem met bewegend tegengewicht, hetgeen het gebruikscomfort sterk verbetert.

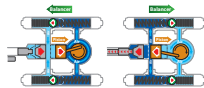

Auto-start wireless system

Dankzij AWS wordt de stofafzuiging bij accu-toestellen automatisch geactiveerd d.m.v. een Bluetooth®-verbinding.



ACCU COMBIHAMERS SDS-PLUS



DHR283G2JU



DHR264PT2J



DHR283ZWJU
inclusief
STOFAFZUIGING



Alle modellen
INCLUSIEF extra
automatische
boorkop



	DHR264PT2J	DHR283ZJU	DHR283ZWJU	DHR283G2JU	
Spanning	2 x 18V	2 x 18V	2x18V	2 x 18V	
Bijgeleverde accu's	2 x BL1850B	0	0	2 x BL1860B	
BL-motor	-	✓	✓	✓	
Slagenergie	2,5 J	2,8 J	2,8J	2,8 J	
Max. Ø beton	26 mm	28 mm	28 mm	28 mm	
AWS	-	✓	✓	✓	
AVT	-	✓	✓	✓	
AFT	-	✓	✓	✓	
Stofafzuigstelsysteem	-	-	DX09	-	
Gewicht	4,2 kg	4,0 kg	5,5 kg	4,0 kg	
Prijs in €	excl. btw	€ 639,00	€ 519,00	€ 569,00	€ 775,00
	incl. btw	€ 773,19	€ 627,99	€ 688,49	€ 937,73

PREMIUM BEITELSET SDS-PLUS EN SDS-MAX

- ✓ 2 keer langere levensduur dan de standaard beitels!
- ✓ Zeer efficiënt: vormvast. Het afbraakwerk is veel productiever!

3-DELIGE PREMIUM BEITELSET SDS-PLUS

SDS- PLUS

E-20220

€ 58,70
excl. btw

€ 71,03
incl. btw



1 puntbeitel 250 mm
1 koudbeitel 20 x 250 mm
1 platte beitel 40 x 250 mm



AntiJam™ ontwerp

Verhoogt de productiviteit
Vermindert de wrijving en de kans op blokkeren
Speciaal ontworpen voor SDS-PLUS machines

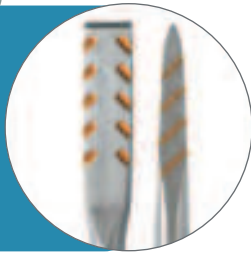

5-DELIGE PREMIUM BEITELSET SDS-MAX

SDS- MAX

E-20236

€ 137,70
excl. btw

€ 166,62
incl. btw



2 puntbeitels 400 mm
2 koudbeitels 25 x 400 mm
1 platte beitel 40 x 400 mm

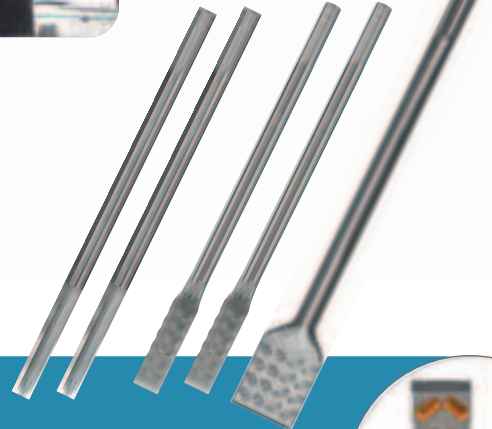

BreakPower™ ontwerp

Verhoogt de productiviteit
Vermindert de wrijving en de kans op blokkeren
Speciaal ontworpen voor SDS-MAX machines

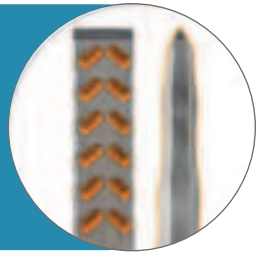

ACCU COMBIHAMER SDS-MAX

BL MOTOR AVT

AWS 18V + 18V → 36V



DHR400ZKU1
incl. stofafzuiging 199142-6

DHR400ZKUN DHR400ZKU1 DHR400G2UN

Spanning	2 x 18V	2 x 18V	2 x 18V	
Bijgeleverde accu's	-	-	2 x BL1860B	
Slagenergie	8 J	8 J	8 J	
Max. Ø beton	40 mm	40 mm	40 mm	
Vibratieniveau hamerboren	5,0 m/s ²	5,0 m/s ²	5,0 m/s ²	
AWS	✓	✓	✓	
AFT	✓	-	✓	
Gewicht	8,1 kg	8,1 kg	8,1 kg	
Prijs in €	excl. btw	€ 799,00	€ 799,00	€ 1.039,00
	incl. btw	€ 966,79	€ 966,79	€ 1.257,19

ACCU HETELUCHTPISTOLEN

18V LITHIUM-ION



DHG180RT1J



DHG181RT1J

- Snelle wissel van het mondstuk
- Veilige schakelaar, te blokkeren in uit en aan stand
- Verschillende mondstukken zijn inbegrepen

		DHG180RT1J	DHG181RT1J
Spanning		18V	18V
Bijgeleverde accu's		1x BL1850B	1x BL1850B
Temperatuurbereik		550 °C	6 standen, max 550 °C
Debiet		200 l/min	120 l/min, 200 l/min
Gewicht		1,0 - 1,3 kg	1,0 - 1,4 kg
Prijs in €	excl. btw	€ 285,00	€ 305,00
	incl. btw	€ 344,85	€ 369,05

ACCU SLAGMOERSLEUTELS



Auto-stop:
de machine stopt automatisch van zodra de bout of moer voldoende is losgedraaid

PROMO

gratis 87-delige gereedschapsset E-08458 bij DTW300RTJ

Wist je dat er van DTW300 de voordelige uitvoeringen DTW300Z en DTW300TJ bestaan? Zie p. 60-61 voor meer uitleg!



DTW1001RTJ



DTW190RTJ



DTW300RTJ



DTW700RTJ



DTW181RTJ

	DTW181RTJ	DTW190RTJ	DTW300RTJ	DTW700RTJ	DTW1001RTJ	DTW1002RTJ	
Spanning	18V	18V	18V	18V	18V	18V	
Bijgeleverde accu's	2 x BL1850B	2 x BL1850B	2 x BL1850B	2 x BL1850B	2 x BL1850B	2 x BL1850B	
BL-motor	✓	-	✓	✓	✓	✓	
XPT	✓	-	✓	✓	-	-	
Toerental	0-2400 tpm.	0-2400 tpm.	0-3200 tpm.	0-2200 tpm.	0-1800 t.p.m.	0-1800 t.p.m.	
Max. koppel	180 Nm	190 Nm	330 Nm	700 Nm	1250 Nm	1200 Nm	
Dopaansluiting	1/2" vierkant	1/2" vierkant	1/2" vierkant	1/2" vierkant	3/4" vierkant	1/2" vierkant	
Auto-stop functie	✓	-	✓	✓	-	-	
Gewicht	1,2 kg	1,4 kg	1,8 kg	2,6 kg	3,4 kg	3,3 kg	
Prijs in €	excl. btw	€ 429,00	€ 399,00	€ 529,00	€ 605,00	€ 649,00	€ 645,00
	incl. btw	€ 519,09	€ 482,79	€ 640,09	€ 732,05	€ 785,29	€ 780,45

ACCU RATELMOERSLEUTEL



Geleverd met 1/4" & 3/8" opname

Verwijderbare kop laat toe om 13 mm moeren over de lengte van een M8 draadstang te schroeven.



DWR180ZJ

	DWR180ZJ	DWR180RA1J	
Spanning	18V	18V	
Bijgeleverde accu's	0	1 x BL1820B	
Toerental onbelast	0-800 t.p.m.	0-800 t.p.m.	
Max. koppel	47,5 Nm	47,5 Nm	
Gewicht	1,2 kg	1,2 kg	
Prijs in €	excl. btw	€ 205,00	€ 299,00
	incl. btw	€ 248,05	€ 361,79

ACCU BREEKMOERSLEUTEL



- Voor het vastdraaien van torsiebreekbouten met een hoge trekvastheid (type HTB/SHTB).
- Torsiebreekbouten worden vooral gebruikt bij industriële staalconstructies.

	DWT310ZK	
Spanning	2x18V	
Bijgeleverde accu's	-	
Toerental onbelast	14 min ⁻¹	
Max. koppel	804 Nm	
Compatibiliteit HTB	M16, M20, M22	
Compatibiliteit SHTB	M16, M20	
Gewicht	6,5 - 7,1 kg	
Prijs in €	excl. btw	€ 1.719,00
	incl. btw	€ 2.079,99



Impact PREMIER

ACCESSOIRES

IMPACT PREMIER

Duurzamer door de dubbele torsie!



E-13568
5-delige schroefbitset



€14,50 excl. btw
€17,55 incl. btw

Past zeer nauwkeurig in de schroef.

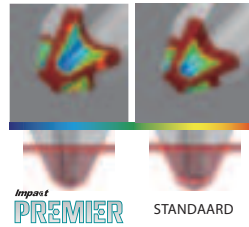

E-03567
11-delige schroefbitset



€28,40 excl. btw
€34,36 incl. btw

Gebruik van hoogwaardig staal. Ondersteunt een hoog koppel.

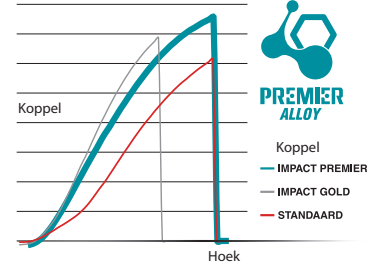

E-13552
31-delige schroefbitset



€56,10 excl. btw
€67,88 incl. btw

Excl. BTW / Incl. BTW

Code	Product	Excl. BTW	Incl. BTW
E-03121	Schroefbit IMPACT PREMIER PH1-25 mm, 2 stks	€ 4,50	€ 5,45
E-03137	Schroefbit IMPACT PREMIER PH2-25 mm, 2 stks	€ 4,50	€ 5,45
E-03143	Schroefbit IMPACT PREMIER PH2(slim)-25 mm, 2 stks	€ 4,50	€ 5,45
E-03159	Schroefbit IMPACT PREMIER PH3-25 mm, 2 stks	€ 4,50	€ 5,45
E-03165	Schroefbit IMPACT PREMIER PZ1-25 mm, 2 stks	€ 4,50	€ 5,45
E-03171	Schroefbit IMPACT PREMIER PZ2-25 mm, 2 stks	€ 4,50	€ 5,45
E-03187	Schroefbit IMPACT PREMIER PZ3-25 mm, 2 stks	€ 4,50	€ 5,45
E-03193	Schroefbit IMPACT PREMIER T10-25 mm, 2 stks	€ 4,50	€ 5,45
E-03202	Schroefbit IMPACT PREMIER T15-25 mm, 2 stks	€ 4,50	€ 5,45
E-03218	Schroefbit IMPACT PREMIER T20-25 mm, 2 stks	€ 4,50	€ 5,45
E-03224	Schroefbit IMPACT PREMIER T25-25 mm, 2 stks	€ 4,50	€ 5,45
E-03230	Schroefbit IMPACT PREMIER T30-25 mm, 2 stks	€ 4,50	€ 5,45
E-20242	Schroefbit IMPACT PREMIER T40-25 mm, 2 stks	€ 5,00	€ 6,05
E-03246	Schroefbit IMPACT PREMIER PH2-25 mm, 15 stks Flip top	€ 22,60	€ 27,35
E-03252	Schroefbit IMPACT PREMIER PZ2-25 mm, 15 stks Flip top	€ 22,60	€ 27,35
E-03268	Schroefbit IMPACT PREMIER PH1-50 mm, 2 stks	€ 6,10	€ 7,38
E-03274	Schroefbit IMPACT PREMIER PH2-50 mm, 2 stks	€ 6,10	€ 7,38
E-03280	Schroefbit IMPACT PREMIER PH3-50 mm, 2 stks	€ 6,10	€ 7,38
E-03296	Schroefbit IMPACT PREMIER PZ1-50 mm, 2 stks	€ 6,10	€ 7,38
E-03305	Schroefbit IMPACT PREMIER PZ2-50 mm, 2 stks	€ 6,10	€ 7,38
E-03311	Schroefbit IMPACT PREMIER PZ3-50 mm, 2 stks	€ 6,10	€ 7,38
E-03327	Schroefbit IMPACT PREMIER T10-50 mm, 2 stks	€ 6,10	€ 7,38
E-03333	Schroefbit IMPACT PREMIER T15-50 mm, 2 stks	€ 6,10	€ 7,38
E-03349	Schroefbit IMPACT PREMIER T20-50 mm, 2 stks	€ 6,10	€ 7,38
E-03355	Schroefbit IMPACT PREMIER T25-50 mm, 2 stks	€ 6,10	€ 7,38
E-03361	Schroefbit IMPACT PREMIER T30-50 mm, 2 stks	€ 6,10	€ 7,38
E-12027	Schroefbit IMPACT PREMIER T40-50 mm, 2 stks	€ 6,10	€ 7,38
E-03377	Schroefbit IMPACT PREMIER PH2-50 mm, 10 stks Flip top	€ 22,70	€ 27,47
E-03383	Schroefbit IMPACT PREMIER PZ2-50 mm, 10 stks Flip top	€ 22,70	€ 27,47

Code	Product	Excl. BTW	Incl. BTW
E-06286	Dubbelbit IMPACT PREMIER PH2-65 mm, 2 stks	€ 8,90	€ 10,77
E-06292	Dubbelbit IMPACT PREMIER PZ2-65 mm, 2 stks	€ 8,90	€ 10,77
E-03399	IMPACT PREMIER Torsion bithouder 68 mm	€ 9,90	€ 11,98
E-03408	IMPACT PREMIER Torsion bithouder 150 mm	€ 10,90	€ 13,19
E-03414	ULTRA MAG bithouder IMPACT PREMIER TORSION	€ 15,10	€ 18,27
E-03420	IMPACT PREMIER Tilt adapter 1/4" voor krachtdoppen 3/8" - 50 mm	€ 8,70	€ 10,53
E-03436	IMPACT PREMIER Tilt adapter 1/4" voor krachtdoppen 1/2" - 50 mm	€ 9,20	€ 11,13
E-03442	IMPACT PREMIER Mag Boost magneet voor schroefbits	€ 4,10	€ 4,96
E-03458	IMPACT PREMIER Torsion dopsleutel H6-65 mm	€ 5,30	€ 6,41
E-03464	IMPACT PREMIER Torsion dopsleutel H8-65 mm	€ 7,10	€ 8,59
E-03470	IMPACT PREMIER Torsion dopsleutel H10-65 mm	€ 7,10	€ 8,59
E-03486	IMPACT PREMIER Torsion dopsleutel H13-65 mm	€ 8,20	€ 9,92
E-03492	IMPACT PREMIER krachtdop H13-80 mm	€ 11,00	€ 13,31
E-03501	IMPACT PREMIER krachtdop H15-80 mm	€ 11,60	€ 14,04
E-03517	IMPACT PREMIER krachtdop H17-80 mm	€ 11,60	€ 14,04
E-03523	IMPACT PREMIER krachtdop H19-80 mm	€ 11,80	€ 14,28
E-03539	IMPACT PREMIER krachtdop H21-80 mm	€ 12,40	€ 15,00
E-03573	11-delige IMPACT PREMIER schroefbitset	€ 28,40	€ 34,36



ACCU HAAKSE
SLAGSCHROEVENDRAAIER



DTL061RTJ

Spanning	18 V
Bijgeleverde accu's	2 x BL1850B
Toerental	0-2000 t.p.m.
Gewicht	1,8 kg
Prijs in €	excl. btw
	incl. btw

€ 519,00
€ 627,99

ACCU SLAGSCHROEVENDRAAIERS



Assist mode: voor het vlot aanzetten bij het schroeven.

T-modus: instelling voor zelftappende schroeven.



DTD157RTJ



DTD153RTJ



DTD172RTJ

PROMO

gratis
neusadapter
194281-7 bij
DTD153RTJ



Wist je dat er van DTD153 de voordelige uitvoeringen DTD153Z en DTD153T1J bestaan? Zie p. 52-53 voor meer info!

	DTD156RTJ	DTD153RTJ	DTD157RTJ	DTD154RTJ	DTD172RTJ	
Spanning	18 V	18 V	18 V	18 V	18 V	
Bijgeleverde accu's	2 x BL1850B	2 x BL1850B	2 x BL1850B	2 x BL1850B	2 x BL1850B	
BL-motor	-	✓	✓	✓	✓	
Toerental	0-2500 t.p.m.	0-3400 t.p.m.	0-3000 t.p.m.	0-3600 t.p.m.	0-3600 t.p.m.	
Max. koppel	155 Nm	170 Nm	140 Nm	175 Nm	180 Nm	
Bitopname	1/4" hex.	1/4" hex.	1/4" hex.	1/4" hex.	1/4" hex.	
Slagkrachtniveau	-	-	2	3	4	
T-modus	-	-	-	✓	✓	
Assist mode	-	-	✓	-	✓	
Gewicht	1,3 kg	1,5 kg	1,2 kg	1,5 kg	1,5 kg	
Prijs in €	excl. btw	€ 379,00	€ 419,00	€ 395,00	€ 455,00	€ 479,00
	incl. btw	€ 458,59	€ 506,99	€ 477,95	€ 550,55	€ 579,59

ACCU HYBRIDE
BOOR- EN SCHROEFMACHINE



4 modi: klopboren, boren schroeven, slagschroeven



DTP141RTJ

DTP141ZJ DTP141RTJ

Spanning	18 V	18 V	
Bijgeleverde accu's	-	2 x BL1850B	
Toerental	0-2700 t.p.m.	0-2700 t.p.m.	
Gewicht	1,8 kg	1,8 kg	
Prijs in €	excl. btw	€ 319,00	€ 579,00
	incl. btw	€ 385,99	€ 700,59

ACCU HYDRAULISCHE
SLAGSCHROEVENDRAAIER



DTS141ZJ

Uiterst stil dankzij het unieke hydraulische impulsstelsysteem

DTS141ZJ

Spanning	18 V	
Bijgeleverde accu's	-	
Toerental	0-3200 t.p.m.	
Max. koppel	40 Nm	
Bitopname	1/4" hex	
T-modus	✓	
Gewicht	1,5 kg	
Prijs in €	excl. btw	€ 459,00
	incl. btw	€ 555,39

ACCU PINPISTOOL
23 Ga



DPT353RTJ

Spanning	18 V	
Bijgeleverde accu's	2 x BL1850B	
Doorsnede nagel	0,6 mm	
Lengte nagel	15-35 mm	
Gewicht	2,0 kg	
Prijs in €	excl. btw	€ 599,00
	incl. btw	€ 724,79

ACCU NIETMACHINES



DST221RTJ

DST221:
Aluminium magazijn

DST112RTJ DST221RTJ

Spanning	18 V	18 V	
Bijgeleverde accu's	2 x BL1850B	2 x BL1850B	
Rugbreedte niet	10 mm	10,5 mm	
Lengte niet	7-10 mm	10-22 mm	
Gewicht	1,5 kg	2,1 kg	
Prijs in €	excl. btw	€ 569,00	€ 589,00
	incl. btw	€ 688,49	€ 712,69

ACCU MINIBRADPISTOLEN
18 Ga



DFN350RTJ



DBN500RTJ

Voor zacht hout

DFN350RTJ DBN500RTJ

Spanning	18 V	18 V	
Bijgeleverde accu's	2 x BL1850B	2 x BL1850B	
Doorsnede nagel	1,2 mm	1,2 mm	
XPT	✓	-	
Lengte nagel	15-35 mm	15-50 mm	
Gewicht	2,1 kg	3,2 kg	
Prijs in €	excl. btw	€ 639,00	€ 719,00
	incl. btw	€ 773,19	€ 869,99

ACCU BRADPISTOOL
16 Ga



Voor zacht hout

DBN600RTJ

Spanning	18 V	
Bijgeleverde accu's	2 x BL1850B	
Doorsnede nagel	1,6 mm	
Lengte nagel	25-64 mm	
Gewicht	3,4 kg	
Prijs in €	excl. btw	€ 745,00
	incl. btw	€ 901,45

ACCU LAMELLENFREES

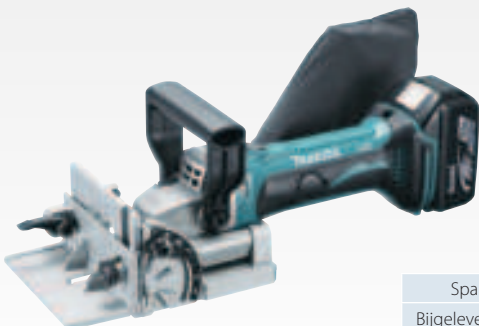

DPJ180RTJ

Spanning	18 V	
Bijgeleverde accu's	2 x BL1850B	
Toerental	6500 t.p.m.	
Gewicht	3,2 kg	
Prijs in €	excl. btw	€ 509,00
	incl. btw	€ 615,89

ACCU SCHAAF



DKP181RTJU



DKP181RTJU

Spanning	18 V	
Bijgeleverde accu's	2 x BL1850B	
Toerental	12000 t.p.m.	
Schaafbreedte	82 mm	
Max. spaanafname	3 mm	
Sponningdiepte	25 mm	
AWS	✓	
Gewicht	3,3 kg	
Prijs in €	excl. btw	€ 595,00
	incl. btw	€ 719,95

ACCU RECIPROZAGEN



DJR189

- Kan met één hand gebruikt worden
- Uitstekend geschikt voor het zagen in nauwe ruimten en in de hoogte
- Uitermate licht en toch zeer krachtig
- Trillingsarm (anti-vibratiesysteem met bewegend tegengewicht)

	DJR189ZJ	DJR183RTJ	DJR186RTE	DJR187RTE	DJR188RTJ	DJR360PT2	
Spanning	18V	18V	18V	18V	18V	2 x 18V	
Bijgeleverde accu's	-	2 x BL1850B	2 x BL1850B	2 x BL1850B	2 x BL1850B	2 x BL1850B	
Bijgeleverde lader	-	DC18RC	DC18RC	DC18RC	DC18RC	DC18RD	
BL-motor	✓	-	-	✓	✓	✓	
Toerental	0-3100 /min	0-3300 /min	0-2800 /min	0-3000 /min	0-3000 /min	0-3000 /min	
Slaglengthe	22 mm	13 mm	32 mm	32 mm	20 mm	32 mm	
Max. capaciteit hout	255 mm	50 mm	255 mm	255 mm	255 mm	255 mm	
Gewicht	2,2 - 2,5 kg	1,6 kg	3,5 kg	3,4 kg	2,9 kg	4,6 kg	
Prijs in €	excl. btw	€ 215,00	€ 399,00	€ 435,00	€ 499,00	€ 455,00	€ 559,00
	incl. btw	€ 260,15	€ 482,79	€ 526,35	€ 603,79	€ 550,55	€ 676,39

ACCU DECOUPEERZAGEN

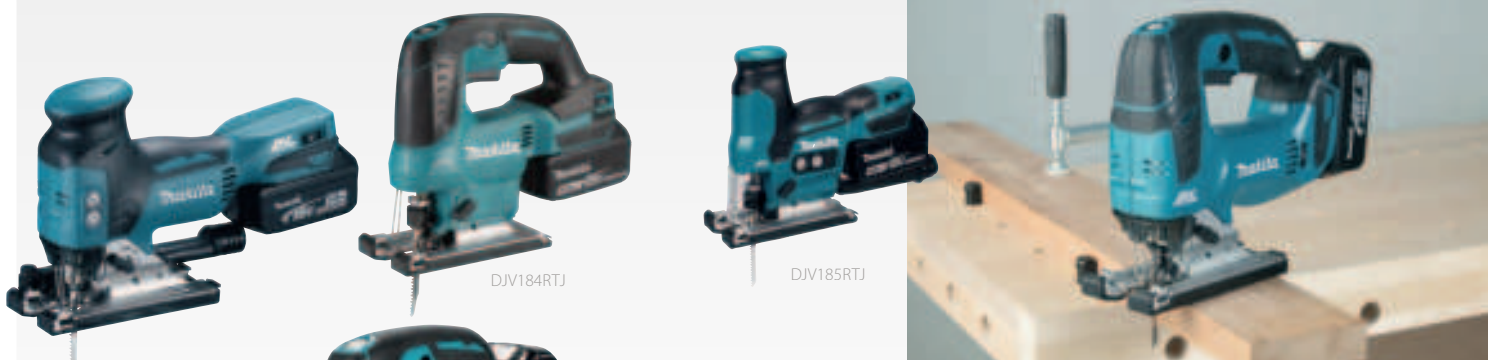

Wist je dat er van DJV181 en DJ182 de voordelige uitvoeringen DJV181Z / DJV181T1J en DJV182Z / DJV182T1J bestaan? Zie p. 60-61 voor meer info!

	DJV184RTJ	DJV185RTJ	DJV181RTJ	DJV182RTJ	
Spanning	18V	18V	18V	18V	
Bijgeleverde accu's	2 x BL1850B	2 x BL1850B	2 x BL1850B	2 x BL1850B	
BL motor	✓	✓	✓	✓	
Aantal zaagbewegingen	0-3000 min ⁻¹	800-3000 min ⁻¹	800-3500 min ⁻¹	800-3500 min ⁻¹	
Max. capaciteit hout	135 mm	135 mm	135 mm	135 mm	
Slaglengthe	23 mm	23 mm	26 mm	26 mm	
Gewicht	2,1 - 2,4 kg	2,0 - 2,3 kg	2,3 - 2,6 kg	2,4 - 2,7 kg	
Prijs in €	excl. btw	€ 439,00	€ 439,00	€ 519,00	€ 519,00
	incl. btw	€ 531,19	€ 531,19	€ 627,99	€ 627,99

ACCU INVALCIRKELZAGEN
165 mm

18V → 18V → 36V



Geleiderail
194368-5 bij PT2J1



DSP600PT2J1

DSP601ZJU DSP600PT2J DSP600PT2J1

	DSP601ZJU	DSP600PT2J	DSP600PT2J1	
Spanning	2 x 18V	2 x 18V	2 x 18V	
Bijgeleverde accu's	0	2 x BL1850B	2 x BL1850B	
Zaagdiepte	56 mm	56 mm	56 mm	
Diameter asgat	20 mm	20 mm	20 mm	
AWS	✓	-	-	
Aantal MAKPAC-koffers	1	2	2	
Gewicht	4,4 kg	4,4 kg	4,4 kg	
Prijs in €	excl. btw	€ 469,00	€ 689,00	€ 749,00
	incl. btw	€ 567,49	€ 833,69	€ 906,29

ACCU METAALCIRKELZAGEN



18V
LITHIUM-ION



DCS552RTJ

DCS553RTJ

DCS552RTJ DCS553RTJ

	DCS552RTJ	DCS553RTJ	
Spanning	18V	18V	
Bijgeleverde accu's	2 x BL1850B	2 x BL1850B	
BL-motor	-	✓	
Ø zaagblad	136 mm	150 mm	
Zaagdiepte (90°)	50,5 mm	57,5 mm	
Gewicht	2,4 kg	3,0 kg	
Prijs in €	excl. btw	€ 489,00	€ 549,00
	incl. btw	€ 591,69	€ 664,29

ACCU CIRKELZAGEN



18V → 18V → 36V

18V
LITHIUM-ION



DHS680RTJ

Promo DHS680RTJ:
gratis 3e BL1850B



DHS782PT2J



DHS660RTJ



DHS900PT2U

Wist je dat er van DHS680 de voordelige uitvoeringen DHS680Z en DHS680T1J bestaan? Zie p. 60-61 voor meer info!

DHS782, DHS783 & DHS900
passen rechtstreeks op geleiderail

	DSS501RTJ	DHS680RTJ	DHS660RTJ	DHS661RTJU	DHS630RTJ	DHS710PT2J	DHS782PT2J	DHS783T2JU	DHS900PT2	DHS900PT2U
Spanning	18V	18V	18V	18V	18V	2 x 18V	2 x 18V	2 x 18V	2 x 18V	2 x 18V
Bijgeleverde accu's	2 x BL1850B	2 x BL1850B	2 x BL1850B	2 x BL1850B	2 x BL1850B	2 x BL1850B	2 x BL1850B	2 x BL1850B	2 x BL1850B	2 x BL1850B
BL-motor	✓	✓	✓	✓	-	-	✓	✓	✓	✓
Zaagdiepte (90°)	51 mm	57 mm	57 mm	57 mm	66 mm	68,5 mm	62,5 mm	62,5 mm	85 mm	85 mm
Ø zaagblad	136 mm	165 mm	165 mm	165 mm	165 mm	190 mm	190 mm	190 mm	235 mm	235 mm
AWS	-	-	-	✓	-	-	-	✓	✓	✓
Gewicht	2,7 kg	3,3 kg	3,4 kg	3,4 kg	3,5 kg	4,7 kg	4,5 kg	4,5 kg	5,3 kg	5,3 kg
Prijs in €	excl. btw	€ 479,00	€ 579,00	€ 549,00	€ 579,00	€ 559,00	€ 609,00	€ 679,00	€ 719,00	€ 775,00
	incl. btw	€ 579,59	€ 700,59	€ 664,29	€ 700,59	€ 676,39	€ 736,89	€ 821,59	€ 869,99	€ 937,75

ACCU AFKORT-VERSTEKZAAG



DLS600RTE



Spanning		18 V
Bijgeleverde accu's		2 x BL1850B
Ø zaagblad		165 mm
Max. zaagcapaciteit bij 90°		46 x 92 mm
Gewicht		6,6 kg
Prijs in €	excl. btw	€ 895,00
	incl. btw	€ 1.082,95

EFFICUT

Fijner, sneller en efficiënter snijden



Scan mij voor meer info!



Meer zaagsneden per batterijlading



Snel zagen



Langere levensduur



Zuivere zaagsnede

ACCU TELESCOPISCHE AFKORT-VERSTEKZAGEN



DXT

Deep and Exact Cutting Technology

De gepatenteerde constructie met drevoudige tandwieloverbrenging en uitsparing achter de flens laat toe om een groter deel van het zaagblad te benutten. Daardoor kunnen ook hoge plinten verticaal of in verstek afgekort worden.



DLS714NPT2 DLS111ZU DLS211ZU

Spanning	2 x 18 V	2 x 18 V	2 x 18 V	
Bijgeleverde accu's	2 x BL1850B	promo: B-67290	promo: B-67315	
Ø Zaagblad	190 mm	260 mm	305 mm	
Zaagdiepte (90°)	52 mm	91 mm	107 mm	
Zaagbreedte (90°)	300 mm	310 mm	363 mm	
DXT	-	✓	✓	
AWS	-	✓	✓	
Gewicht	13,0 kg	27,3 kg	30,7 kg	
Prijs in €	excl. btw	€ 965,00	€ 865,00	€ 1.049,00
	incl. btw	€ 1.167,65	€ 1.046,65	€ 1.269,29

ACCU MENGER



Ideaal voor het mengen van vloeistoffen, verf en lichte lijmsorten.

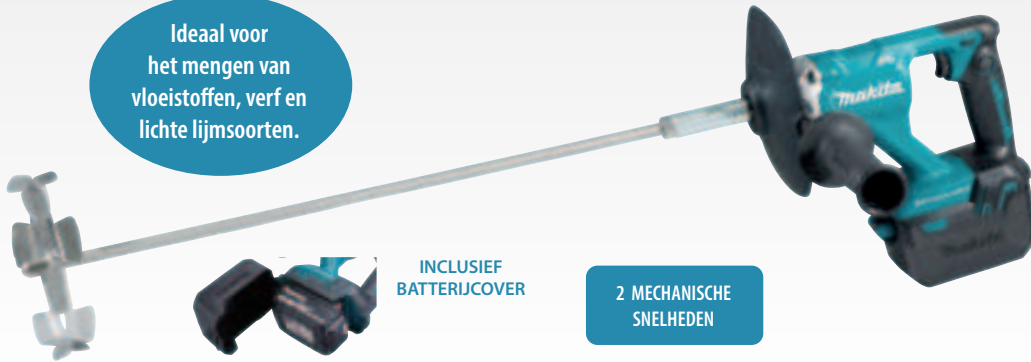

INCLUSIEF BATTERIJCOVER

2 MECHANISCHE SNELHEDEN

DUT130RTE

Spanning	18V	
Bijgeleverde accu's	2 x BL1850B	
Diameter mengblad	165 mm	
Aansluiting	M12-M14	
Toerental	0-350 / 0-1300 t.p.m.	
Gewicht	2,5 kg	
Prijs in €	excl. btw	€ 589,00
	incl. btw	€ 712,69

ACCU LANGNEKSCHUURMACHINE 225 MM



● Accessoires

Steunschijf

Type	Ref.	Prijs excl. btw	Prijs incl. btw
Zacht	199939-3	€ 74,00	€ 89,54
Medium	199940-8	€ 74,00	€ 89,54
Hard	199938-5	€ 74,00	€ 89,54



Schuurschijf 225 mm (per 25)

Korrel	Ref.	Prijs excl. btw	Prijs incl. btw
P40	B-68389	€ 41,00	€ 49,61
P80	B-68395	€ 41,00	€ 49,61
P120	B-68404	€ 37,40	€ 45,25
P180	B-68410	€ 41,00	€ 49,61
P320	B-68426	€ 41,00	€ 49,61



DSL801ZU

DSL800ZU



De beschermkap van de DSL800 heeft één rechte kant, dat laat toe dicht langs een muur of plafond te bewegen.



De beschermkap van de DSL801 is volledig rond, dit is gunstig voor de stofafvoer.



Telescopische buis
De totale lengte van de machine kan aangepast worden van 1100 tot 1520 mm



Verlengstuk
Met het optionele verlengstuk met steun (199937-7) kan langer comfortabel in de hoogte gewerkt worden.

DSL800ZU DSL801ZU

Spanning	18V	18V
Bijgeleverde accu's	0	0
AWS	✓	✓
Toerental onbelast	1000-1800 t.p.m.	1000-1800 t.p.m.
Diameter schuurschijf	225 mm	225 mm
Lengte	1100 -1520 mm	1100 -1520 mm
Gewicht	4,8 kg	4,8 kg
Prijs in €	excl. btw	€ 639,00
	incl. btw	€ 773,19

ACCU GIPSFREES



DCO181Z

Spanning	18V	
Bijgeleverde accu's	0	
Toerental	0 - 32000 t.p.m.	
AWS	✓ excl. Bluetooth unit	
BL-Motor	✓	
Gewicht	1,4 kg	
Prijs in €	excl. btw	€ 225,00
	incl. btw	€ 272,25

ACCU GIPSAZAG



DSD180ZJ

Spanning	18V	
Bijgeleverde accu's	0	
Slaglengte	6 mm	
Gewicht	1,7 kg	
Prijs in €	excl. btw	€ 235,00
	incl. btw	€ 284,35

ACCU SCHROEFAUTOMATEN



• **"Push Drive"-technologie:** de motor start automatisch wanneer de neus van de machine tegen de ondergrond wordt gedrukt.



DFR551RTJ



DFR550ZJ

	DFR550ZJ	DFR750Z	DFR452RTJ	DFR551RTJ
Spanning	18V	18V	18V	18V
Bijgeleverde accu's	0	0	2x BL1850B	2x BL1850B
Toerental	4000 t.p.m.	4000 t.p.m.	6000 t.p.m.	6000 t.p.m.
BL motor	-	-	✓	✓
Ø Gipsplaatschroef	4,0 mm	4,0 mm	3,5-4,2 mm	3,5-4,2 mm
Schroeflengte	25-55 mm	45-75 mm	20-41 mm	25-55 mm
"Push drive" technologie	-	-	✓	✓
Gewicht	2,1 kg	2,1 kg	2,2 kg	2,2 kg
Prijs in €	excl. btw	€ 299,00	€ 299,00	€ 609,00
	incl. btw	€ 361,79	€ 361,79	€ 736,89

ACCU SCHROEVENDRAAIERS



Duw-aandraaistand ("Push drive")



In de duw-aandraaistand gaan de motor en de schroefkop automatisch draaien wanneer er druk op wordt uitgeoefend.



DFS250RTJ



DFS452FJX2

	DFS250RTJ	DFS452RAJ	DFS452FJX2
Spanning	18V	18V	18V
Bijgeleverde accu's	2 x BL1850B	2 x BL1820B	2 x BL1830B
Toerental	0-2500 t.p.m.	0- 4000 t.p.m.	0-4000 t.p.m.
Incl. schroeflintadapter	-	-	✓
Schroeflengte	-	-	25-55 mm
"Push drive" technologie	-	✓	✓
Gewicht	1,5 kg	1,5 kg	1,5 kg
Prijs in €	excl. btw	€ 439,00	€ 425,00
	incl. btw	€ 531,19	€ 514,25

ACCU BOVEN- EN KANTENFREES



	DRT50ZJX3	DRT50RTJX3
Spanning	18V	18V
Bijgeleverde accu's	0	2 x BL1850B
Max. induikdiepte	35 mm	35 mm
Toerental onbelast	10.000-30.000 t.p.m.	10.000-30.000 t.p.m.
Ø spatang - bereik	6 - 8 mm	6 - 8 mm
Ø spatang - inbegrepen	6 mm, 8 mm	6 mm, 8 mm
Gewicht	2,1 kg	2,1 kg
Prijs in €	excl. btw	€ 345,00
	incl. btw	€ 417,45

ACCU HANDPALMVLAKSCHUURMACHINES



DBO480: standaard met extra driehoekszool

Promo
DBO480RTJ, DBO481RTJ
en DBO482RTJ:
gratis extra accu BL1830B

	DBO480RTJ	DBO481RTJ	DBO482RTJ	DBO484ZJ
Spanning	18 V	18 V	18 V	18 V
Bijgeleverde accu's	2x BL1850B	2x BL1850B	2x BL1850B	-
Afmetingen schuurvoet	112 mm x 102 mm	112 mm x 102 mm	112 mm x 102 mm	112 mm x 102 mm
Papierbevestiging	Klem/Velcro	Klem	Klem	Klem/Velcro
Materiaal schuurvoet	Kunststof	Kunststof	Aluminium	Aluminium
Aantal schuurbewegingen	22000/28000 min ⁻¹	22000/28000 min ⁻¹	22000/28000 min ⁻¹	22000/28000 min ⁻¹
Schuuruitslag	1,5 mm	1,5 mm	1,5 mm	1,5 mm
AWS ready	-	-	✓	✓
Gewicht	1,4-1,8 kg	1,4-1,8 kg	1,4-1,8 kg	1,4-1,8 kg
Prijs in €	excl. btw	€ 379,00	€ 359,00	€ 375,00
	incl. btw	€ 458,59	€ 434,39	€ 453,75

ACCU VLAKSCHUURMACHINES



DBO381RTJU

DBO382ZJ

	DBO380RTJ	DBO381RTJU	DBO382ZJ
Spanning	18 V	18 V	18 V
Bijgeleverde accu's	2x BL1850B	2x BL1850B	2x BL1850B
Afmetingen schuurvoet	92 mm x 185 mm	92 mm x 185 mm	92 mm x 185 mm
Papierbevestiging	Klem	Klem	Klem/velcro
Materiaal schuurvoet	Aluminium	Aluminium	Aluminium
Aantal schuurbewegingen	8000/16000/24000 min ⁻¹	8000/16000/24000 min ⁻¹	8000/16000/24000 min ⁻¹
Schuuruitslag	2,0 mm	2,0 mm	2,0 mm
AWS	-	✓	-
Gewicht	1,9 - 2,2 kg	1,9 - 2,2 kg	1,9 - 2,2 kg
Prijs in €	excl. btw	€ 405,00	€ 439,00
	incl. btw	€ 490,05	€ 531,19

ACCU EXCENTRISCHE SCHUURMACHINE 125 MM



DBO180

	DBO180RTJ	
Spanning	18 V	
Bijgeleverde accu's	2 x BL1850B	
Diameter schuurvoet	125 mm	
Aantal schuurbewegingen	14000 - 22000 mm ⁻¹	
Schuuruitslag	2,8 mm	
Gewicht	1,7 kg	
Prijs in €	excl. btw	€ 419,00
	incl. btw	€ 506,99

ACCU EXCENTRISCHE POLIJSTMACHINES



DPO500Z

	DPO500Z	DPO600Z
Spanning	18 V	18 V
Bijgeleverde accu's	0	0
Oscillatiefrequentie	0-13600 min ⁻¹	0-13600 min ⁻¹
Schuurvoet	125 mm	150 mm
Schuuruitslag	5,5 mm	5,5 mm
Gewicht	3,1 kg	3,1 kg
Prijs in €	excl. btw	€ 365,00
	incl. btw	€ 441,65

Vrije rotatie en geforceerde rotatie

ACCU BANDSCHUURMACHINE 9 MM



Hoog gebruikskomfort en perfecte balans door centrale plaatsing van de motor

Richtbare led en zijhandgreep



Werkbereik 90° (met uiterste stand 160° voor het opbergen)

	DBS180RTJ	
Spanning	18 V	
Bijgeleverde accu's	2 x BL1850B	
Bandsnelheid	600 - 1700 m/min	
Schuurband	9 x 533 mm	
Gewicht	1,8 - 2,1 kg	
Prijs in €	excl. btw	€ 615,00
	incl. btw	€ 744,15

ACCU MULTITOOL

Wist je dat er van DTM51 de voordelige uitvoeringen DTM51Z en DTM51T1JX2 bestaan? Zie p. 60-61 voor meer info



Gereedschapsloze accessoirewissel

DTM51RTJX2

STARLOCK STARLOCK PLUS STARLOCK MAX



DTM52 incl. accessoires

DTM51

- Compatibel met OIS en Starlock (niet met Starlock Plus en Starlock Max).

Inclusief: set van 9 accessoires, 30 schuurvellen, 1 afzuigset

DTM52

- Compatibel met Starlock, Starlock Plus en Starlock Max accessoires, ideaal voor de zwaardere toepassingen.
- Grote oscillatiehoek van 1,8° links/rechts
- Zeer lage trillingswaarden dankzij AVT technologie
- Kleine greepomtrek en laag gewicht

	DTM51RTJX2	DTM52RTJX1
Spanning	18 V	18 V
Bijgeleverde accu's	2 x BL1850B	2 x BL1850B
BL motor	-	✓
Oscillatiefrequentie	6000-20000 /min	10000-20000 /min
Oscillatiehoek	3,2°	3,6°
Opname	OIS, Starlock	Starlock, Starlock Plus, Starlock Max
Gewicht	2,0 kg	1,7 kg
Prijs in €	excl. btw	€ 499,00
	incl. btw	€ 603,79
Prijs in €	excl. btw	€ 529,00
	incl. btw	€ 640,09

STARLOCK



STARLOCK PLUS



STARLOCK MAX



Voor het totaal overzicht van het assortiment scan hier

- ✓ Snelle wissel van accessoires door een simpele klik
- ✓ Starlock Plus zaagbladen : snel, diep en veelzijdig invallend zagen
- ✓ Starlock Max zaagbladen : zelfs voor de meest veeleisende en zware toepassingen

Starlock Plus en Starlock Max accessoires kunnen enkel gebruikt worden met de DTM52.

ACCU SCHUURPOLIJSTMACHINE 75 MM



Polijsten
Steunschijf met velcro opname voor polijst toepassingen.



Compact
Uiterst compacte machine met de handgreep kort bij de schijf voor een optimale controle.

DPV300RTJ

- Zeer compacte machine ideaal voor het schuren en polijsten van kleine oppervlakken.
- Twee mechanische versnellingen en traploze snelheidsregeling.
- Geleverd met velcro steunschijf voor het polijsten en een Roloc™ opname voor schuurtoepassingen.



Schuren
Roloc™ compatibele opname voor schuurtoepassingen.

Accessoires

Steunschijf

Referentie	Omschrijving	Prijs excl. btw	Prijs incl. btw
E-07412	Schuurschijf aluminiumoxide 50 mm A60 (25 st.)	€ 51,00	€ 61,71
E-07428	Schuurschijf aluminiumoxide 50 mm A80 (25 st.)	€ 51,00	€ 61,71
E-07434	Schuurschijf aluminiumoxide 50 mm A120 (25 st.)	€ 51,00	€ 61,71
E-07440	Schuurschijf zirconium 50 mm Z60 (25 st.)	€ 51,00	€ 61,71
E-07456	Schuurschijf zirconium 50 mm Z80 (25 st.)	€ 51,00	€ 61,71
E-07462	Vliesschijf zirconium Grof / Hard 50 mm (25 st.)	€ 87,40	€ 105,75
E-07478	Vliesschijf zirconium Medium / Hard 50 mm (25 st.)	€ 85,70	€ 103,70
E-07484	Vliesschijf zirconium Fijn / Hard 50 mm (25 st.)	€ 87,40	€ 105,75
E-07490	Vliesschijf zirconium Medium/ Zacht 50 mm (25 st.)	€ 82,20	€ 99,46
E-07509	Vliesschijf zirconium Fijn/Zacht 50 mm (25 st.)	€ 82,20	€ 99,46
E-07515	Vliesschijf zirconium Zeer fijn/ Zacht 50 mm (25 st.)	€ 82,20	€ 99,46

DPV300RTJ

Bijgeleverde accu's	2 x BL1850	
Capaciteit polijsten	80 mm	
Capaciteit schuren	50 mm	
Toerental polijsten	0-2800 min ⁻¹	
Toerental schuren	0-9500 min ⁻¹	
Gewicht	1,3 kg	
Prijs in €	excl. btw	€ 519,00
	incl. btw	€ 627,99

ACCU BANDZAGEN

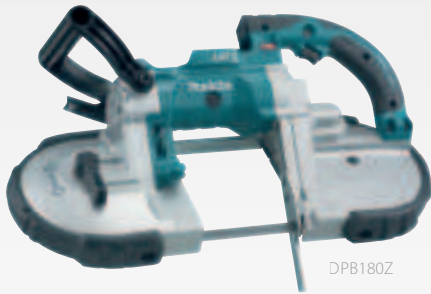

DPB180Z

Aluminium
behuizing



DPB183Z



DPB184Z

	DPB180Z	DPB184Z	DPB183Z
Spanning	18 V	18 V	18 V
Bijgeleverde accu's	-	-	-
Bijgeleverde lader	-	-	-
Max. bandsnelheid	162 m/min	192 m/min	192 m/min
Capaciteit stalen buis	120 x 120 mm	51 x 51 mm	66 x 66 mm
BL-motor	-	✓	✓
Gewicht	6,8 kg	3,2 kg	3,8 kg
Prijs in €	excl. btw	€ 405,00	€ 315,00
	incl. btw	€ 490,05	€ 381,15
		€ 335,00	€ 405,35

ACCU METAALAFKORTMACHINE



DLW140PG2

Gereedschapsloze (hoek)-
verstelling van de geleider.

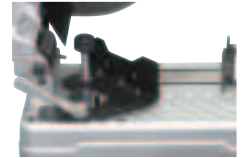

	DLW140Z	DLW140PG2	
Spanning	2 x 18 V	2 x 18 V	
Bijgeleverde accu's	0	2 x BL1860B	
Toerental onbelast	3800 t.p.m.	3800 t.p.m.	
Diameter schijf	355 mm	355 mm	
Gewicht	16,9 kg	16,9 kg	
Prijs in €	excl. btw	€ 425,00	€ 689,00
	incl. btw	€ 514,25	€ 833,69

ACCU BLINDKLINKNAGELPISTOLEN



DRV150Z



Scan deze code
voor uitgebreide
technische info.

	DRV150Z	DRV250Z	
Bijgeleverde accu's/lader	-	-	
Trekkraft	10 kN	20 kN	
Compatibel met blindklinknagel Ø	24 / 32 / 40 / 48 mm	48 / 60 / 64 mm	
Slaglengthe	25 mm	30 mm	
Gewicht	1,9 kg	2,1 kg	
Prijs in €	excl. btw	€ 829,00	€ 829,00
	incl. btw	€ 1.003,09	€ 1.003,09

ACCU AFKORTSLIJPMACHINES

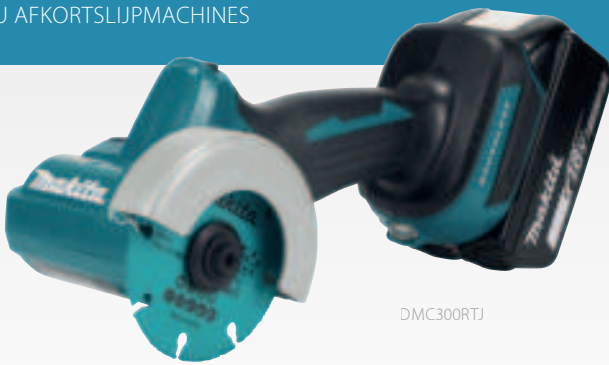

DMC300RTJ

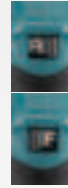

DMC300

- Zeer compacte slijpmachine, ideaal voor het zagen op moeilijk bereikbare plaatsen
- Goed uitgebalanceerd, kan veilig met één hand gebruikt worden
- De draairichting is omkeerbaar
- Stofkap met aansluiting voor stofafzuiging standaard bijgeleverd
- Voor het zagen in staal, keramiek en kunststoffen



D-74815-5 D-77263 D-74837

Accessoires

Ref	Type	Prijs excl. btw	Prijs incl. btw
D-74815-5	Doorslijpschijf voor RVS 76mm (5 stuks)	€ 4,90	€ 5,93
D-77263	Diamantschijf 76x1,4x10mm	€ 8,50	€ 10,29
D-74837	Carbide multi-snijschijf 76x10mm	€ 8,50	€ 10,29

	DMC300ZJ	DMC300RTJ
Spanning	18 V	18 V
Bijgeleverde accu's	-	2x BL1850B
Lader	-	DC18RC
Ø schijf	76 mm	76 mm
Toerental onbelast	20000 min ⁻¹	20000 min ⁻¹
Max. zaagdiepte	met stofkap: 13,5 mm zonder stofkap: 16,0 mm	met stofkap: 13,5 mm zonder stofkap: 16,0 mm
Gewicht	1,2 - 1,7 kg	1,2 - 1,7 kg
Prijs in €	excl. btw	€ 159,00
	incl. btw	€ 192,39

ACCU DOORSLIJPER



DCE090T2X1

Maximale zaagdiepte 88 mm

Promo
DCE090ZK1 en DCE090T2X1:
gratis 25 doorslijpschijven RVS

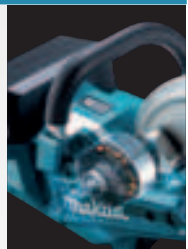

Accessoires

Ref	Type	Prijs excl. btw	Prijs incl. btw
E-03006-25	Doorslijpschijf RVS (25 st.) 230 x 2,0 x 22,23 mm	€ 80,60	€ 97,53
E-02967	Diamantschijf 230 mm x 2,4 x 22,23 mm	€ 172,70	€ 208,97

De gesegmenteerde diamantschijf E-02967 werd speciaal ontwikkeld voor het gebruik met een accu doorslijper. De diamantkorrels zijn gelijkmatig verdeeld en volgens een speciaal V-vormig patroon ingebed. Daardoor blijft de schijf continu scherp en zijn de zaagprestaties optimaal.



	DCE090ZK1	DCE090T2X1
Spanning	2 x 18 V	2 x 18 V
Bijgeleverde accu's	0	2 x BL1850B
Lader	-	DC18RD
Ø schijf	230 mm	230 mm
Toerental onbelast	6600 min ⁻¹	6600 min ⁻¹
Max. zaagdiepte	88 mm	88 mm
Max. schijfdikte	3,0 mm	3,0 mm
Gewicht	5,6 - 6,3 kg	5,6 - 6,3 kg
Prijs in €	excl. btw	€ 549,00
	incl. btw	€ 664,29

ACCU DIAMANTZAAG 125 MM



Inclusief 2 stofkappen, voor droog en nat gebruik

Ideaal voor afwerking (steen, beton, keramiek)

Kantelbaar tot 45°

	DCC501RTJ	
Spanning	18 V	
Toerental onbelast	8500 min ⁻¹	
AWS	✓ excl. Bluetooth unit	
Diameter asgat	20 mm	
Bijgeleverde accu's	2 x BL1850B	
Gewicht	2,7 kg	
Prijs in €	excl. btw	€ 525,00
	incl. btw	€ 635,25

ACCU HAAKSE SLIJERS 125 MM

ADT AFT **BL MOTOR**

Wist je dat er van DGA506 en DGA508 de voordelige uitvoeringen DGA506Z / DGA506T1J en DGA508Z / DGA508T1J bestaan? Zie p. 60-61 voor meer info!

Promo
DGA506T1J en DGA508T1J:
gratis 10 doorslijpschijven
D-18770-10 zie p. 59

18V LITHIUM-ION **MAX PAC**

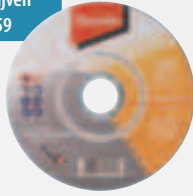

DGA506RTJ

DGA518RTJU

Promo
DGA506RTJ en DGA508RTJ:
gratis extra accu BL1850B

	DGA506RTJ	DGA508RTJ	DGA513RTJ	DGA514RTJU	DGA517RTJ	DGA518RTJU
Spanning	18V	18V	18V	18V	18V	18V
Bijgeleverde accu's	2 x BL1850B	2 x BL1850B	2 x BL1850B	2 x BL1850B	2 x BL1850B	2 x BL1850B
Ø schijf	125 mm	125 mm	125 mm	125 mm	125 mm	125 mm
Heropstartbeveiliging	✓	✓	✓	✓	✓	✓
Elektrische rem	✓	✓	✓	✓	✓	✓
Regelbaar toerental	-	-	✓	✓	✓	✓
AWS	-	-	-	✓	-	✓
Schakelaar	Schuifschakelaar met vergrendeling	Lepeschakelaar, zonder vergrendeling	Schuifschakelaar met vergrendeling	Schuifschakelaar met vergrendeling	Lepeschakelaar, zonder vergrendeling	Lepeschakelaar, zonder vergrendeling
Gewicht	2,5 kg	2,5 kg	2,5 kg	2,5 kg	2,5 kg	2,5 kg
Prijs in €	excl. btw	€ 459,00	€ 455,00	€ 489,00	€ 529,00	€ 489,00
	incl. btw	€ 555,39	€ 550,55	€ 591,69	€ 640,09	€ 591,69

BESCHERMKAP MET STOFAFZUIGING VOOR HAAKSE SLIJERS



230 mm

Draaibaar

Met één druk op de knop kan je de diepte instellen

Kijkvenster

198440-5



125 mm

196845-3

	196845-3	198440-5
Diameter stofkap	125 mm	230 mm
Max. zaagdiepte	20 mm	60 mm
Prijs in €	excl. btw	€ 86,40
	incl. btw	€ 104,54
Prijs in €	excl. btw	€ 155,40
	incl. btw	€ 188,403

ACCU STEMPELSLIJPER



18V LITHIUM-ION



DGD800RTJ

Spanning	18V	
Bijgeleverde accu's	2 x BL1850B	
Toerental	25000 t.p.m.	
Ø spantang - bereik	6 - 8 mm	
Ø spantang - inbegrepen	6 mm	
Gewicht	2,1 kg	
Prijs in €	excl. btw	€ 449,00
	incl. btw	€ 543,29

ACCU HAAKSE SLIJERS 180-230 MM

ADT AFT **18V + 18V** **36V**

BL MOTOR



DGA701ZKU

	DGA701ZKU	DGA900ZK	DGA901PGZU
Spanning	2 x 18V	2 x 18V	2 x 18V
Bijgeleverde accu's	0	0	2 x BL1860B
Ø schijf	180 mm	230 mm	230 mm
AWS	✓	-	✓
Gewicht	5,0 kg	5,2 kg	5,2 kg
Prijs in €	excl. btw	€ 349,00	€ 325,00
	incl. btw	€ 422,29	€ 393,25
Prijs in €	excl. btw	€ 649,00	€ 649,00
	incl. btw	€ 785,29	€ 785,29

ACCU HAAKSE SLIJPER 125 MM X-LOCK



DGA519RTJ

DGA521ZX1



Snel en veilig schijven bevestigen via een kliksysteem.



ACCESSOIRES X-LOCK

Referentie	Type	Prijs excl. btw	Prijs incl. btw
E-00393	Afbraamschijf voor metaal 125 mm x 6 x 22,23	€ 3,70	€ 4,48
E-00402	Afbraamschijf voor inox 125 mm x 6 x 22,23	€ 4,10	€ 4,96
E-00418	Doorslijpschijf voor inox 125 mm x 1,2 x 22,23	€ 3,00	€ 3,63
E-02076	Diamantdoorslijpschijf 125 mm	€ 39,40	€ 47,67
191G05-4	Beschermkap met stofafzuiging 125 mm	€ 101,20	€ 122,45
D-73396	Komborstel voor metaal, gegolfde draad 75 mm x 0,3	€ 14,10	€ 17,06
D-73433	Komborstel voor metaal, gegolfde draad, vermessingd 75 mm x 0,3	€ 14,10	€ 17,06
D-73346	Komborstel voor inox, gegolfde draad 75 mm x 0,3	€ 20,80	€ 25,17
D-73374	Komborstel voor metaal, getordeerde draad 80 mm x 0,35	€ 15,60	€ 18,88
D-73380	Komborstel voor metaal, getordeerde draad 80 mm x 0,5	€ 15,60	€ 18,88
D-73330	Komborstel voor inox, getordeerde draad 80 mm x 0,5	€ 25,00	€ 30,25
D-73449	Kegelborstel voor metaal, gegolfde draad 100 mm x 0,3	€ 17,20	€ 20,81
D-73411	Schijfborstel voor metaal, getordeerde draad 115 mm x 0,5	€ 21,90	€ 26,50
D-73427	Schijfborstel voor metaal, gegolfde draad 115 mm x 0,3	€ 19,80	€ 23,96
E-11776	Doorslijpschijf TCG 125 mm x 2 x 22,23 X-Lock	€ 22,50	€ 27,23
E-19738	Vacuüm gesoldeerde diamantschijf 125 mm	€ 68,90	€ 83,37

	DGA521ZX1	DGA520ZX1	DGA519ZJ	DGA519RTJ
Spanning	18 V	18 V	18 V	18 V
Bijgeleverde accu's	0	0	0	2 x BL1850B
Ø schijf	125 mm	125 mm	125 mm	125 mm
Toerental onbelast	8500 min ⁻¹	8500 min ⁻¹	3000 - 8500 t.p.m.	3000 - 8500 t.p.m.
Heropstartbeveiliging	✓	✓	✓	✓
Elektrische rem	-	✓	✓	✓
Regelbaar toerental	-	-	✓	✓
Type schakelaar	Schuifschakelaar met vergrendeling	Lepelschakelaar zonder vergrendeling	Lepelschakelaar zonder vergrendeling	Lepelschakelaar zonder vergrendeling
Gewicht	2,4 - 3,0 kg	2,4 - 3,0 kg	2,5 kg	2,5 kg
Prijs in €	excl. btw	€ 209,00	€ 229,00	€ 269,00
	incl. btw	€ 252,89	€ 277,09	€ 325,49

ACCU KNABBELSCHAAR



DJN161RTJ

Spanning	18 V
Bijgeleverde accu's	2 x BL1850B
Max. aantal snijbewegingen	1900 min ⁻¹
Max. dikte staal	1,6 mm
Gewicht	2,2 kg
Prijs in €	excl. btw
	incl. btw

ACCU PLAATSCHAREN



DJS130ZJ

DJS131Z

DJS200Z

DJS800Z



DJS800

- Geschikt voor het knippen van o.a. cementbeplating, brandwerende platen en geluidsisolatieplaten tot 13 mm dikte.
- Knipt vrijwel stofvrij, snel en zonder lawaai.
- De snijkop is 360° draaibaar voor knippen op moeilijk bereikbare plaatsen.

bij alle modellen kan de kop 360° gedraaid worden

DJS131: kan bochten en gegolfde staalplaat snijden

DJS130/DJS200: voor het knippen van rechte stukken met minimale vervorming

	DJS130ZJ	DJS200Z	DJS131Z	DJS800Z
Spanning	18 V	18 V	18 V	18 V
Bijgeleverde accu's	-	-	-	-
BL-motor	-	✓	✓	✓
Aantal zaagbewegingen	2800 min ⁻¹	0-3000 min ⁻¹	0-3000 min ⁻¹	0-3000 min ⁻¹
Max. dikte staal	1,3 mm	2,0 mm	1,3 mm	13 mm (vezelcement)
Gewicht	2,3 - 2,6 kg	2,2 - 2,5 kg	2,0 - 2,3 kg	2,1 - 2,5 kg
Prijs in €	excl. btw	€ 375,00	€ 425,00	€ 519,00
	incl. btw	€ 453,75	€ 514,25	€ 627,99

ACCU VLECHTMACHINE



DTR180ZJ



DTR181ZJ

DTR181

- Deze versie kan grotere verbindingen maken, tot bijvoorbeeld: (2 x 16 mm) + (2 x 13 mm) of 25 mm + 22 mm.

Promo
DTR180ZJ :
gratis doos gegalvaniseerde
binddraad 191A57-9

Optioneel accessoire:
handgreep 191M27-0
€ 203,00 excl. btw
€ 245,63 incl. btw



		DTR180ZJ	DTR181ZJ
Spanning		18 V / 14,4 V	18 V / 14,4 V
Bijgeleverde accu's		0	0
Vlechtcapaciteit		10 mm + 10 mm (2 x 13 mm) + (2 x 13 mm)	16 mm + 16 mm (2 x 16 mm) + (2 x 13 mm)
Draaddikte		0,8 mm	0,8 mm
Modus		Enkelvoudig/continu	Enkelvoudig/continu
Gewicht		2,3 kg	2,3 kg
Prijs in €	excl. btw	€ 979,00	€ 1.019,00
	incl. btw	€ 1.184,59	€ 1.232,99



Polyester draad: 191J59-9
(100 m, Ø 0,8 mm) 50 stuks/doos

€ 311,90 excl. btw
€ 377,40 incl. btw



Vlechtdraad gegalvaniseerd: 191A57-9
(100 m, Ø 0,8 mm) 50 stuks/doos

€ 252,00 excl. btw
€ 304,92 incl. btw



Vlechtdraad staal: 199137-9
(100 m, Ø 0,8 mm) 50 stuks/doos

€ 215,00 excl. btw
€ 260,15 incl. btw

ACCU VACUÛMPOMP



DVP181

- Kan continu werken dankzij twee accu's in parallel
- Tweetraps pomp met hoog debiet



DVP181ZK



DVP180Z

DVP180Z

DVP181ZK

		DVP180Z	DVP181ZK
Spanning		18 V	18 V, 2 accu's in parallel
Bijgeleverde accu/lader		-	-
Compressor		ééntraps olieafgedichte schottenpomp	Tweetraps olieafgedichte schottenpomp
Debiet		60 l/min	113 l/min
Eindvacuüm		20 Pa (150 micron)	3 Pa (22,5 micron)
Gewicht		2,9 kg	8,2 kg
Prijs in €	excl. btw	€ 355,00	€ 799,00
	incl. btw	€ 429,55	€ 966,79

ACCU KITPISTOOL



INCLUSIEF
kokerhouder
600 ml bij
DCG180RAX



DCG180RA
300 ml

DCG180RAX

DCG180RA

DCG180RAX

		DCG180RA	DCG180RAX
Spanning		18 V	18 V
Bijgeleverde accu's		1 x BL1820B	1 x BL1820B
Max. spuitdruk		5000 N	5000 N
Max. extrusiesnelheid		0-28 mm/s	0-28 mm/s
Gewicht		2,1 kg	2,4 kg
Prijs in €	excl. btw	€ 379,00	€ 425,00
	incl. btw	€ 458,59	€ 514,25

Voor gebruiksklaar afkorten zonder vonken

Mobiel afkorten



DSC102ZJ



DSC121ZK

Stationair afkorten



DSC102

	DSC102ZJ	DSC121ZK	
Spanning	18 V	18 V	
Bijgeleverde accu's	0	0	
Snijcapaciteit	M6/M8/M10	M8/M10/M12	
Inbegrepen messenset	M8/M10	M8	
Gewicht	3,3 kg	5,7 kg	
Prijs in €	excl. btw	€ 639,00	€ 1.779,00
	incl. btw	€ 773,19	€ 2.152,59

ACCU BETONIJSERZAAG



DSC251ZK

Spanning	18 V	
Bijgeleverde accu's/lader	0	
Snijcapaciteit	10-25 mm	
Gewicht	3,9 kg	
Prijs in €	excl. btw	€ 1.069,00
	incl. btw	€ 1.293,49

ACCU HYDRAULISCHE BETONIJSERKNIPPERS



DSC163ZK

DSC163ZK DSC191Z

Spanning	18 V	18 V	
Bijgeleverde accu's/lader	-	-	
Snijcapaciteit	3 - 16 mm	3 - 20 mm	
BL-motor	✓	-	
Gewicht	6,9 kg	11,1 - 11,2 kg	
Prijs in €	excl. btw	€ 1.989,00	€ 2.189,00
	incl. btw	€ 2.406,69	€ 2.648,69

ACCU PONSMACHINE



DPP200ZK

Spanning	18 V	
Max. diameter ponsgat	20 mm	
Inbegrepen Ø	12 mm	
Max. dikte staal	8 mm	
Max. dikte inox	6 mm	
Gewicht	10,5 kg	
Prijs in €	excl. btw	€ 2.349,00
	incl. btw	€ 2.842,29

Werkt met standaard
400 g patronen of vet
in bulk



Debietregeling:
automatisch of traag
(met hoogste druk)



DGP180RT

Hogedrukslang
van 120 cm



DGP180RA

		DGP180Z	DGP180RT
Spanning		18V	18V
Bijgeleverde accu's		-	1 x BL1850B
Maximale druk		690 bar	690 bar
Debiet		145-290 ml/min	145-290 ml/min
Gewicht		4,8 kg	4,8 kg
Prijs in €	excl. btw	€ 305,00	€ 469,00
	incl. btw	€ 369,05	€ 567,49



DVR850Z



- Voeding middels PDC draagbaar accupack (accupack niet inbegrepen)
- Zeer comfortabel werken omdat enkel de trilnaald gehanteerd moet worden.
- Compatibel met flessen met grote diameter Ø 43 mm en Ø 52 mm
- Werktijd tot 300 minuten met PDC1200

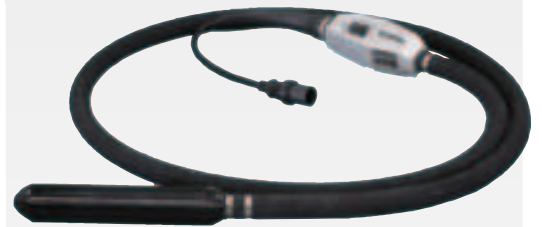

VR004C

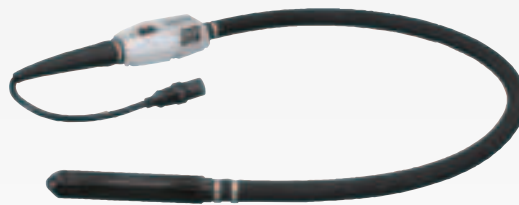

VR001C



		DVR350Z	DVR450Z	DVR850Z
Spanning		18V	18V	18V
Bijgeleverde accu's		0	0	0
Lengte trilnaald		80 cm	120 cm	240 cm
Diameter trilnaald		25 mm	25 mm	25 mm
Gewicht		2,0 kg	2,3 kg	2,4 kg
Prijs in €	excl. btw	€ 325,00	€ 355,00	€ 465,00
	incl. btw	€ 393,25	€ 429,55	€ 562,65

		VR001CZ	VR002CZ	VR003CZ	VR004CZ
Spanning		36V (Direct connect)	36V (Direct connect)	36V (Direct connect)	36V (Direct connect)
Bijgeleverde accu's		-	-	-	-
Trilfrequentie		1200 min ⁻¹	1200 min ⁻¹	1200 min ⁻¹	1200 min ⁻¹
Ø triffles		43 mm	43 mm	52 mm	52 mm
Lengte trilnaald		1,5 m	3,0 m	1,5 m	3,0 m
Autonomie (PDC1200)		300 min	300 min	200 min	200 min
Gewicht		11,8 kg	12,9 kg	12,6 kg	13,7 kg
Prijs in €	excl. btw	€ 2.099,00	€ 2.299,00	€ 2.199,00	€ 2.399,00
	incl. btw	€ 2.539,79	€ 2.781,79	€ 2.660,79	€ 2.902,79

BESPAAR MET ONZE COMBOPACKS

PROMO

Gratis extra BL1830B bij al deze combopacks

MACHINES IN COMBOPACK 18 V		ACCU	DC18RC	MAK-PAC	PRIJS IN €
		3 x  BL1850B			€ 509,00 excl. btw € 615,89 Incl. btw
DDF485	DTD153				
		3 x  BL1850B			€ 569,00 excl. btw € 688,49 incl. btw
DDF484	DTD153				
		2 x  BL1850B			€ 699,00 excl. btw € 845,79 Incl. btw
DDF489	DHR243				
		3 x  BL1850B			€ 589,00 excl. btw € 712,69 Incl. btw
DTD153	DTD153				
		3 x  BL1850B			€ 689,00 excl. btw € 833,69 Incl. btw
DGA506	DHP486				

DLX2289T3J

DLX2189T3J

DLX2522TJ

DLX2236T1J

DLX2434TJ

PROMO

Gratis extra BL1830B bij combopacks op deze pagina





BESPAAR MET ONZE COMBOPACKS

	DHP486	DTD153	DHR243	DGA506	DHS680	DJV181	DTM51
DLX2418TJ							
DLX4159TJ							
DLX5093TJ							
DLX5071TJ							
DLX6128JX1							
DLX1055JX1							
DLX1122JX1							

PROMO batterij BL1850B meteen geleverd in Makpac

Combineer voordelig
met deze aanbieding

Promo
D-42444 bij DHR243T1J en
DHR243Z

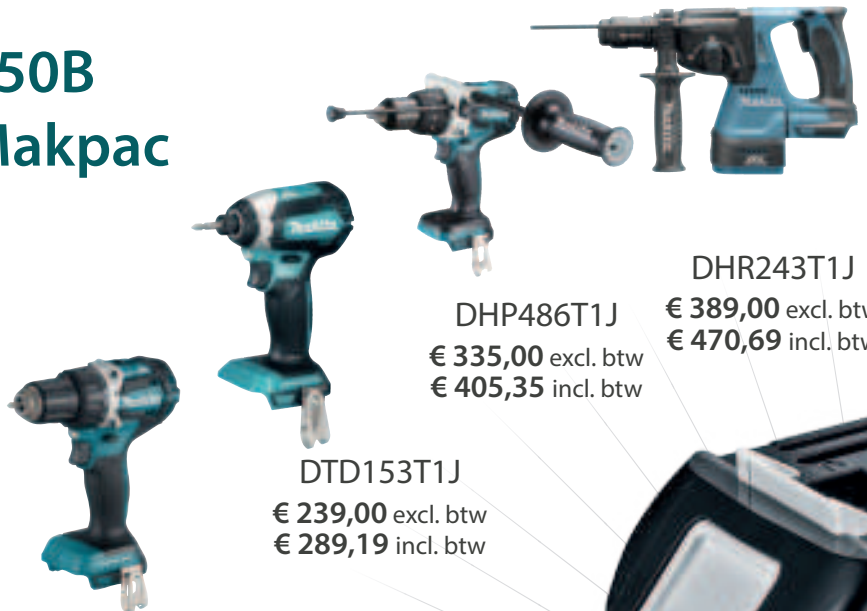
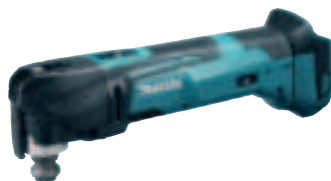

DDF484T1J
€ 245,00 excl. btw
€ 296,45 incl. btw

DTD153T1J
€ 239,00 excl. btw
€ 289,19 incl. btw

DHP486T1J
€ 335,00 excl. btw
€ 405,35 incl. btw

DHR243T1J
€ 389,00 excl. btw
€ 470,69 incl. btw

DTM51T1JX2
€ 345,00 excl. btw
€ 417,45 incl. btw





TR00000001

TROLLEY

€ 168,90 excl. btw

€ 204,37 incl. btw



DJR188Z	DRT50ZJX3	DBO180ZJ	DDA351ZJ	BL1850B 18V 5,0 Ah	DC18RC	KOFFER	PROMO	PRIJS IN €
				3 x 			PROMO BL1850B	€ 629,00 excl. btw € 761,09 incl. btw
				3 x 		2 x 	PROMO BL1850B	€ 1.119,00 excl. btw € 1.353,99 incl. btw
				3 x 		3 x 	PROMO BL1850B	€ 1.269,00 excl. btw € 1.535,49 incl. btw
				3 x 		3 x 	PROMO BL1850B	€ 1.249,00 excl. btw € 1.511,29 incl. btw
				3 x 		4 x 	PROMO TR00000001	€ 1.529,00 excl. btw € 1.850,09 incl. btw
				5 x 	2 x 	9 x 	PROMO TR00000001	€ 2.425,00 excl. btw € 2.934,25 incl. btw
				5 x 	2 x 	10 x 	PROMO TR00000001	€ 2.649,00 excl. btw € 3.205,29 incl. btw



DHS680T1J

€ 345,00 excl. btw
€ 417,45 incl. btw



DTW300T1J

€ 329,00 excl. btw
€ 398,09 incl. btw



DJV181T1J

€ 309,00 excl. btw
€ 373,89 incl. btw



DJV182T1J

€ 309,00 excl. btw
€ 373,89 incl. btw

DGA506T1J

€ 279,00 excl. btw
€ 337,59 incl. btw



DGA508T1J

€ 285,00 excl. btw
€ 344,85 incl. btw



Deze modellen bestaan ook in een voordelige 'Z-versie' zonder accu, lader, Makpac of andere extra toebehoren.

Extra promo DGA506T1J & DGA508T1J: Gratis 10 doorslijpschijven D-18770-10



HET LXT -PLATFORM

DBN500ZJ

Minibradpistool 18V

Prijs excl. BTW
€ 475,00

Prijs incl. BTW
€ 574,75

Makpac



DBN600ZJ

Bradpistool 18V

Prijs excl. BTW
€ 489,00

Prijs incl. BTW
€ 591,69

Makpac



DBO180ZJ

Excentrische schuurmachine 18V

Prijs excl. BTW
€ 159,00

Prijs incl. BTW
€ 192,39

Makpac



DBO380ZJ

Vlakschuurmachine 18V

Prijs excl. BTW
€ 175,00

Prijs incl. BTW
€ 211,75

Makpac



DBO381ZJU

Vlakschuurmachine 18V

Prijs excl. BTW
€ 199,00

Prijs incl. BTW
€ 240,79

Makpac



DBO480ZJ

Vlakschuurmachine 18V

Prijs excl. BTW
€ 139,00

Prijs incl. BTW
€ 168,19

Makpac



DBO481ZJ

Vlakschuurmachine 18V

Prijs excl. BTW
€ 119,00

Prijs incl. BTW
€ 143,99

Makpac



DBO482ZJ

Vlakschuurmachine 18V

Prijs excl. BTW
€ 129,00

Prijs incl. BTW
€ 156,09

Makpac



DBS180ZJ

Bandschuurmachine 9 mm 18V

Prijs excl. BTW
€ 369,00

Prijs incl. BTW
€ 446,49

Makpac



DCB200B

Verwamd deken 18V

Prijs excl. BTW
€ 139,00

Prijs incl. BTW
€ 168,19

Karton



DCC501ZJ

Diamantzaag 125 mm 18V

Prijs excl. BTW
€ 275,00

Prijs incl. BTW
€ 332,75

Makpac



DCG180ZK

Kitpistool 18V

Prijs excl. BTW
€ 249,00

Prijs incl. BTW
€ 301,29

Koffer



DCG180ZXK

Kitpistool 18V incl. kokerhouder

Prijs excl. BTW
€ 285,00

Prijs incl. BTW
€ 344,85

Koffer



DCO181Z

Gipsfrees 18V

Prijs excl. BTW
€ 225,00

Prijs incl. BTW
€ 272,25

Karton



DCS552ZJ

Metaalcirkelzaag 18V

Prijs excl. BTW
€ 245,00

Prijs incl. BTW
€ 296,45

Makpac



DCS553ZJ

Metaalcirkelzaag 18V

Prijs excl. BTW
€ 315,00

Prijs incl. BTW
€ 381,15

Makpac



DDA351ZJ

Haakse boormachine 18V

Prijs excl. BTW
€ 229,00

Prijs incl. BTW
€ 277,09

Makpac



DDA450ZK

Haakse boormachine 18V

Prijs excl. BTW
€ 319,00

Prijs incl. BTW
€ 385,99

Koffer

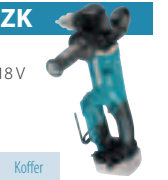

DDF083ZJ

Boor- en schroefmachine 1/4" 18V

Prijs excl. BTW
€ 149,00

Prijs incl. BTW
€ 180,29

Makpac



DDF482ZJ

Boor- en schroefmachine 18V

Prijs excl. BTW
€ 129,00

Prijs incl. BTW
€ 156,09

Makpac



DDF484Z

Boor- en schroefmachine 18V

Prijs excl. BTW
€ 129,00

Prijs incl. BTW
€ 156,09

Karton



DDF489ZJ

Boor- en schroefmachine 18V

Prijs excl. BTW
€ 189,00

Prijs incl. BTW
€ 228,69

Makpac



DDF486ZJ

Boor- en schroefmachine 18V

Prijs excl. BTW
€ 225,00

Prijs incl. BTW
€ 272,25

Makpac



DFN350ZJ

Minibradpistool 18V

Prijs excl. BTW
€ 415,00

Prijs incl. BTW
€ 502,15

Makpac



DFR452ZJ

Schroefautomaat 18V

Prijs excl. BTW
€ 375,00

Prijs incl. BTW
€ 453,75

Makpac



DFR550ZJ

Schroefautomaat 18V

Prijs excl. BTW
€ 399,00

Prijs incl. BTW
€ 361,79

Makpac



DFR551ZJ

Schroefautomaat 18V

Prijs excl. BTW
€ 399,00

Prijs incl. BTW
€ 470,69

Makpac



DFR750Z

Schroefautomaat 18V

Prijs excl. BTW
€ 299,00

Prijs incl. BTW
€ 361,79

Karton



DFS250ZJ

Schroefmachine 18V

Prijs excl. BTW
€ 209,00

Prijs incl. BTW
€ 252,89

Makpac



DFS452ZJ

Schroefmachine 18V

Prijs excl. BTW
€ 239,00

Prijs incl. BTW
€ 289,19

Makpac



DGA506Z

Haakse slijper 125 mm 18V

Prijs excl. BTW
€ 165,00

Prijs incl. BTW
€ 199,65

Karton



DGA508Z

Haakse slijper 125 mm 18V

Prijs excl. BTW
€ 195,00

Prijs incl. BTW
€ 235,95

Karton



DGA513ZJ

Haakse slijper 125 mm 18V

Prijs excl. BTW
€ 239,00

Prijs incl. BTW
€ 289,19

Makpac



DGA514ZJU

Haakse slijper 125 mm 18V

Prijs excl. BTW
€ 279,00

Prijs incl. BTW
€ 337,59

Makpac



DGA517ZJ

Haakse slijper 125 mm 18V

Prijs excl. BTW
€ 239,00

Prijs incl. BTW
€ 289,19

Makpac



DGA518ZJU

Haakse slijper 125 mm 18V

Prijs excl. BTW
€ 279,00

Prijs incl. BTW
€ 337,59

Makpac

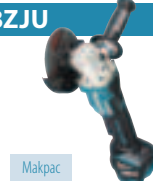

DGA519ZJ

Haakse slijper 125 mm X-lock 18V

Prijs excl. BTW
€ 269,00

Prijs incl. BTW
€ 325,49

Makpac



DGA520ZX1

Haakse slijper 125 mm X-lock 18V

Prijs excl. BTW
€ 229,00

Prijs incl. BTW
€ 277,09

Karton



DGA521ZX1

Haakse slijper 125 mm X-lock 18V

Prijs excl. BTW
€ 209,00

Prijs incl. BTW
€ 252,89

Karton



DGD800ZJ

Stempelslijper 18V

Prijs excl. BTW
€ 199,00

Prijs incl. BTW
€ 240,79

Makpac



DGP180Z

Vetpomp 18V

Prijs excl. BTW
€ 305,00

Prijs incl. BTW
€ 369,05

Karton



DHG180ZJ

Heteluchtspistool 18V

Prijs excl. BTW
€ 155,00

Prijs incl. BTW
€ 187,55

Makpac



DHG181ZJ

Heteluchtspistool 18V

Prijs excl. BTW
€ 175,00

Prijs incl. BTW
€ 211,75

Makpac



DHP484ZJ

Klopboor- en schroefmachine 18V

Prijs excl. BTW
€ 169,00

Prijs incl. BTW
€ 204,49

Makpac



DHP489ZJ

Klopboor

DHR243ZJW

SDS-PLUS Boorhamer 18 V + DX07

Prijs excl. BTW
€ 395,00
Prijs incl. BTW
€ 477,95



Makpac

DHR264ZJ

Combihamer SDS+ 2 x 18 V

Prijs excl. BTW
€ 355,00
Prijs incl. BTW
€ 429,55



Makpac

DHS630ZJ

Cirkelzaag 165 mm 18 V

Prijs excl. BTW
€ 325,00
Prijs incl. BTW
€ 393,25



Makpac

DHS660ZJ

Cirkelzaag 165 mm 18 V

Prijs excl. BTW
€ 295,00
Prijs incl. BTW
€ 356,95



Makpac

DHS661ZJU

Cirkelzaag 165 mm 18 V

Prijs excl. BTW
€ 335,00
Prijs incl. BTW
€ 405,35



Makpac

DHS680Z

Cirkelzaag 165 mm 18 V

Prijs excl. BTW
€ 245,00
Prijs incl. BTW
€ 296,45



Karton

DHS710ZJ

Cirkelzaag 190 mm 2 x 18 V

Prijs excl. BTW
€ 329,00
Prijs incl. BTW
€ 398,09



Makpac

DHS782ZJ

Cirkelzaag 190 mm 2 x 18 V

Prijs excl. BTW
€ 415,00
Prijs incl. BTW
€ 502,15



Makpac

DHS783ZJU

Cirkelzaag 190 mm 2 x 18 V

Prijs excl. BTW
€ 455,00
Prijs incl. BTW
€ 550,55



Makpac

DHS900Z

Cirkelzaag 235 mm 2 x 18 V

Prijs excl. BTW
€ 479,00
Prijs incl. BTW
€ 579,59



Karton

DHS900ZU

Cirkelzaag 235 mm 2 x 18 V

Prijs excl. BTW
€ 519,00
Prijs incl. BTW
€ 627,99



Karton

DJN161ZJ

Knabberschaar 18 V

Prijs excl. BTW
€ 435,00
Prijs incl. BTW
€ 526,35



Makpac

DJR183ZJ

Reciprozaag 18 V

Prijs excl. BTW
€ 139,00
Prijs incl. BTW
€ 168,19



Makpac

DJR186ZK

Reciprozaag 18 V

Prijs excl. BTW
€ 179,00
Prijs incl. BTW
€ 216,59



Koffer

DJR187ZK

Reciprozaag 18 V

Prijs excl. BTW
€ 245,00
Prijs incl. BTW
€ 296,45



Koffer

DJR188ZJ

Reciprozaag 18 V

Prijs excl. BTW
€ 229,00
Prijs incl. BTW
€ 277,09



Makpac

DJR189ZJ

Reciprozaag 18 V

Prijs excl. BTW
€ 215,00
Prijs incl. BTW
€ 260,15



Makpac

DJR360ZK

Reciprozaag 2 x 18 V

Prijs excl. BTW
€ 279,00
Prijs incl. BTW
€ 337,59



Koffer

DCV202ZL

Bodywarmer 18 V (maat: L)

Prijs excl. BTW
€ 185,00
Prijs incl. BTW
€ 223,85



Makpac

DCJ205ZL

Verwarmde jas 18 V (maat: L)

Prijs excl. BTW
€ 215,00
Prijs incl. BTW
€ 260,15



Karton

DCJ206ZXL

Verwarmde jas 18 V (maat: XL)

Prijs excl. BTW
€ 245,00
Prijs incl. BTW
€ 296,45



Karton

DJV181Z

Decoupeerzaag 18 V

Prijs excl. BTW
€ 245,00
Prijs incl. BTW
€ 296,45



Karton

DJV182Z

Decoupeerzaag 18 V

Prijs excl. BTW
€ 245,00
Prijs incl. BTW
€ 296,45



Karton

DJV184Z

Decoupeerzaag 18 V

Prijs excl. BTW
€ 185,00
Prijs incl. BTW
€ 223,85



Karton

DJV185Z

Decoupeerzaag 18 V

Prijs excl. BTW
€ 185,00
Prijs incl. BTW
€ 223,85



Karton

DKP181ZU

Schaaf 18 V

Prijs excl. BTW
€ 359,00
Prijs incl. BTW
€ 434,39



Karton

DLS600Z

Afkort-verstekzaag 165 mm 18 V

Prijs excl. BTW
€ 649,00
Prijs incl. BTW
€ 785,29



Karton

DPJ180ZJ

Lamellenfrees 18 V

Prijs excl. BTW
€ 259,00
Prijs incl. BTW
€ 313,39



Makpac

DPT353ZJ

Pinpistool 18 V

Prijs excl. BTW
€ 375,00
Prijs incl. BTW
€ 453,75



Makpac

DPV300ZJ

Schuur- en polijst-machine 75 mm 18 V

Prijs excl. BTW
€ 275,00
Prijs incl. BTW
€ 332,75



Makpac

DRT50ZJ

Boven- en kantenfrees 18 V

Prijs excl. BTW
€ 209,00
Prijs incl. BTW
€ 252,89



Makpac

DRV150ZJ

Blindklinknagel-pistool 18 V

Prijs excl. BTW
€ 829,00
Prijs incl. BTW
€ 1.003,09



Makpac

DRV250ZJ

Blindklinknagel-pistool 18 V

Prijs excl. BTW
€ 829,00
Prijs incl. BTW
€ 1.003,09



Makpac

DSD180ZJ

Gipszaag 18 V

Prijs excl. BTW
€ 235,00
Prijs incl. BTW
€ 284,35



Makpac

DSP600ZJ

Invalcirkelzaag 165 mm 2 x 18 V

Prijs excl. BTW
€ 435,00
Prijs incl. BTW
€ 526,35



Makpac

DSS501ZJ

Cirkelzaag 136 mm 18 V

Prijs excl. BTW
€ 209,00
Prijs incl. BTW
€ 252,89



Makpac

DST112ZJ

Nietmachine 18 V

Prijs excl. BTW
€ 319,00
Prijs incl. BTW
€ 385,99



Makpac

DST221ZJ

Nietmachine 18 V

Prijs excl. BTW
€ 335,00
Prijs incl. BTW
€ 405,35



Makpac

DTD153Z

Slagschroevendraaier 18 V

Prijs excl. BTW
€ 139,00
Prijs incl. BTW
€ 168,19



Karton

DTD154ZJ

Slagschroevendraaier 18 V

Prijs excl. BTW
€ 219,00
Prijs incl. BTW
€ 264,99



Makpac

DTD156Z

Slagschroevendraaier 18 V

Prijs excl. BTW
€ 109,00
Prijs incl. BTW
€ 131,89



Karton

DTD157ZJ

Slagschroevendraaier 18 V

Prijs excl. BTW
€ 155,00
Prijs incl. BTW
€ 187,55



Makpac

DTD172ZJ

Slagschroevendraaier 18 V

Prijs excl. BTW
€ 229,00
Prijs incl. BTW
€ 277,09



Makpac

DTL061ZJ

Haakse slagschroevendraaier 18 V

Prijs excl. BTW
€ 259,00
Prijs incl. BTW
€ 313,39



Makpac

DTM51Z

Multitool 18 V

Prijs excl. BTW
€ 165,00
Prijs incl. BTW
€ 199,65



Karton

DTM52ZJ

Multitool 18 V

Prijs excl. BTW
€ 249,00
Prijs incl. BTW
€ 301,29



Makpac

DTW1001ZJ

Slagmoersleutel 18 V

Prijs excl. BTW
€ 389,00
Prijs incl. BTW
€ 470,69



Makpac

DTW1002ZJ

Slagmoersleutel 18 V

Prijs excl. BTW
€ 395,00
Prijs incl. BTW
€ 477,95



Makpac

DTW180ZJ

Slagmoersleutel 18 V

Prijs excl. BTW
€ 165,00
Prijs incl. BTW
€ 199,65



Makpac

DTW181ZJ

Slagmoersleutel 18 V

Prijs excl. BTW
€ 165,00
Prijs incl. BTW
€ 199,65



Makpac

DTW190ZJ

Slagmoersleutel 18 V

Prijs excl. BTW
€ 135,00
Prijs incl. BTW
€ 163,35



Makpac

DTW300Z

Slagmoersleutel 18 V

Prijs excl. BTW
€ 229,00
Prijs incl. BTW
€ 277,25



Karton

DTW700ZJ

Slagmoersleutel 18 V

Prijs excl. BTW
€ 355,00

ACCU VERWARMD ONDERHEMD

DCX200 - DCX201

- DCX200 serie: met open ronde hals. DCX201 serie: met rechtopstaande kraag en halve ritssluiting
- Voeding middels 14,4V/18V LXT-batterij of compacte BL1055B
- Zeer dunne en elastische stof, waardoor het hemd onder andere kleding gedragen kan worden
- Vier warmtezones en 3 warmtestanden
- Machinewasbaar en geschikt voor droogkast



DEABL1055B
Powerbank
€ 159,00 excl. btw
€ 192,39 incl. btw



DCX200C

DCX201C

		DCX200C	DCX201C
Maat		S-M-L-XL-2XL-3XL	
Voeding		14.4V/18V LXT BL1055B	14.4V/18V LXT BL1055B
Incl. batterijadapter		TD00000111	TD00000111
Model		Open hals	Met kraag en halve ritssluiting
Vermogenniveaus		2,3W / 4,5W / 9,5W	2,3W / 4,5W / 9,5W
Verwarmingszones		4	4
Materiaal		100% polyester	100% polyester
Machine wassen/drogen		✓	✓
Prijs in €	Excl. BTW	€ 165,00	€ 165,00
	Incl. BTW	€ 199,65	€ 199,65

VERWARME JASSEN / BODYWARMERS CXT & LXT



CJ106
DCJ206

CJ106 EN DCJ206:
HIGH VISIBILITY
(CONFORM
ISO 20471/ANSI107)

CV102 EN DCV202:
ZONDER MOUWEN
(BODYWARMER)



CV102
DCV202

		CJ105DZ	DCJ205Z	CJ106DZ	DCJ206Z	CV102DZ	DCV202Z
Maat		S-M-L-XL-2XL-3XL					
Spanning		10,8V	18V	10,8V	18V	10,8V	18V
Model		Jas - zwart	Jas - zwart	Jas - High Visibility	Jas - High Visibility	Bodywarmer	Bodywarmer
Vermogen		2,3W - 7W - 11,5W	2,3W - 7W - 11,5W	2,3W - 7W - 11,5W	2,3W - 7W - 11,5W	2,3W - 4,5W - 9,5W	2,3W - 4,5W - 9,5W
Verwarmingszones		5	5	5	5	4	4
Materiaal buitenzijde		Polyester	Polyester	Polyester	Polyester	Polyester Spandex	Polyester Spandex
Materiaal binnenzijde		Fleece	Fleece	Fleece	Fleece	Fleece	Fleece
Water- & windresistent		✓	✓	✓	✓	✓	✓
Machine wassen/drogen		✓	✓	✓	✓	✓	✓
Aantal zakken		6	6	6	6	4	4
Prijs in €	Excl. BTW	€ 209,00	€ 215,00	€ 239,00	€ 245,00	€ 175,00	€ 185,00
	Incl. BTW	€ 252,89	€ 260,15	€ 289,19	€ 296,45	€ 211,75	€ 223,85

ACCU VERWARMD DEKEN



DCB200B

GESCHIKT VOOR
WASMACHINE &
DROOGKAST

		CB100DB	DCB200B
Bijgeleverde accu's		0	0
Afmetingen (LxB)		700 x 1400 mm	
Vermogen		2,3 W - 4,5 W - 9,5 W	
Materiaal		Polyester	
Spanning		10,8 V	14,4 V/18 V
Prijs in €	excl. btw	€ 135,00	€ 139,00
	incl. btw	€ 163,35	€ 168,19

ACCU GEVENTILEERDE VESTEN



Bescherm uzelf tegen de hitte met onze geventileerde vesten op accu!



DFV210Z

Polyester
Waterafstotend
DFV210
Zijdellingse ventilatoren
€ 125,00 excl. btw
€ 151,25 incl. btw



DFV214A01

DFV214A01 (S-L) / DFV214A02 (XL-3XL)
Zijdellingse ventilatoren
€ 99 excl. btw
€ 119,79 incl. btw



DFJ212Z

Polyester
Waterafstotend
DFJ212
Zijdellingse ventilatoren
€ 139,00 excl. btw
€ 168,19 incl. btw



DFJ210Z DFJ211Z

Polyester
Waterafstotend en
vochtdoorlatend
DFJ210/211 (met kap)
Zijdellingse ventilatoren
€ 115 / € 125 excl. btw
€ 139,15 / € 151,25 incl. btw



DFJ213Z

Polyester
Stretch
DFJ213
Zijdellingse ventilatoren
€ 149,00 excl. btw
€ 180,29 incl. btw



DFJ304Z

Katoen
Vochtabsorberend
DFJ304
Zijdellingse ventilatoren
€ 125,00 excl. btw
€ 151,25 incl. btw



DFJ214Z

Polyester
Waterafstotend en
antistatisch
DFJ214
Zijdellingse ventilatoren
€ 159,00 excl. btw
€ 192,39 incl. btw



DFJ410Z DFJ411Z

Polyester met
titanium coating
UV- en IR-reflectorend -
stretch
DFJ410/DFJ411 (met kap)
Zijdellingse ventilatoren
€ 129,00 / € 139,00 excl. btw
€ 156,09 / € 168,19 incl. btw

maat (cm)	S	M	L	XL	2XL	3XL
Lengte			70	71	72	73
Schouder			48	50	52	54
Mouw*			93	95	97	99
Borst			127	132	137	142
Taille			121	126	131	136
Lengte			69	70	71	72
Schouder			51	53	55	57
Mouw			66	67	68	69
Borst			127	132	137	142
Taille			113 ~ 121	118 ~ 126	123 ~ 131	128 ~ 136
Lengte			72	73	74	75
Schouder			51	53	55	57
Mouw			66	67	68	69
Borst			127	132	137	142
Taille			113 ~ 121	118 ~ 126	123 ~ 131	128 ~ 136
Lengte	64	66	68	70	72	74
Schouder	51.55	4	56.55	9	61.56	4
Mouw	54	56	58	60	62	64
Borst	116	121	126	131	136	141
Taille	77 ~ 108	82 ~ 113	87 ~ 113	92 ~ 113	97 ~ 113	102 ~ 133
Lengte			71	72	73	74
Schouder			47	49	51	53
Borst			123	128	133	138
Taille			117	122	127	132

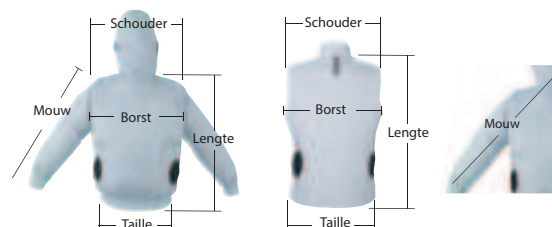

198634-2
Accu-adaptor LXT-batterijen
€ 44,80 excl. btw
€ 54,21 incl. btw



198639-2
Accu-adaptor CXT-batterijen
€ 44,80 excl. btw
€ 54,21 incl. btw

ACCU VENTILATOREN

CF003G



Ideaal voor het ventileren van grotere ruimten, zoals magazijnen of werkplaatsen.



Voeding middels XGT/LXT accu's netstroom



Variabele toerentalregeling



	DCF102Z	DCF203Z	DCF301Z	CF001GZ	CF002GZ	CF003GZ	
Spanning	18 V / 14,4 V	18 V / 14,4 V	18 V / 14,4 V	36 V (40Vmax) XGT / AC	36 V (40Vmax) XGT / AC	36 V (40Vmax) XGT / 18 V LXT / AC	
AC adapter	Optioneel	Optioneel	inclusief	inclusief	inclusief	inclusief	
Diameter	180 mm	235 mm	300 mm	235 mm	330 mm	450 mm	
Auto zwenken L/R	✓	✓	✓	✓	✓	✓	
Timer	✓	✓	✓	✓	✓	✓	
Gewicht	1,3 kg	2,5 kg	4,3 kg	2,0 - 3,0 kg	4,5 - 5,1 kg	7,9 - 10,5 kg	
Prijs in €	excl. btw	€ 89,00	€ 125,00	€ 175,00	€ 139,00	€ 199,00	€ 445,00
	incl. btw	€ 107,69	€ 151,25	€ 211,75	€ 168,19	€ 240,79	€ 538,45

ACCU KOFFIEZETAPPARAAT



Ideaal voor op de bouw- en werkplaats. Werkt zowel met koffiepads als met gemalen koffie. Met één accu (LXT 5,0 Ah) maak je 3 koppen koffie van 160 ml.

DCM501Z

Spanning	10,8V/14,4V/18V	
Bijgeleverde accu's	0	
Inhoud waterreservoir	240 ml	
Bereidingstijd met 18V accu (150 ml)	5 min.	
Gewicht	1,9 - 2,2 kg	
Prijs in €	excl. btw	€ 109,00
	incl. btw	€ 131,89

ACCU WATERKOKER



- Dubbellaagse roestvrijstalen wand
- Met voedingsstandaard en groot handvat
- Uitgerust met morsbeveiliging

DKT360Z

DKT360Z

KT001GZ

Spanning	2x18V	36 V (40Vmax)
Inhoud	0,8 l	0,8 l
Kooktijd voor 0,8 l	ca. 8 min	ca. 8 min
Verwarmcapaciteit 100 °C	1,2 l met 2 x BL1850	1,2 l met 2 x BL4025
Gewicht	2,7 - 3,4 kg	2,8 - 5,9 kg
Prijs in €	excl. btw	€ 199,00
	incl. btw	€ 240,79

MINILUCHTPOMP



DMP180Z



Standaard met verschillende ventieladapters



Bedieningspaneel

De DMP181 is uitgerust met een groot display met achtergrondverlichting.

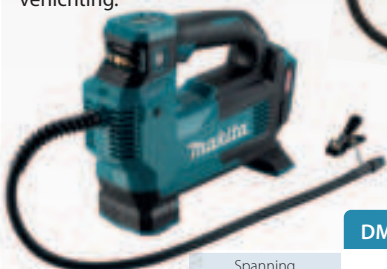

MP001GZ

	DMP180Z	DMP181Z	MP001GZ
Spanning	18V	18V	36 V (40Vmax)
Bijgeleverde accu/lader	-	-	0
Debiet	10 l/min	11 - 22 l/min	12 - 24 l/min
Max. druk	8,3 bar	11,1 bar	11,1 bar
Gewicht	1,5 kg	2,5 - 2,8 kg	2,9 - 3,5 kg
Prijs in €	excl. btw	€ 99,00	€ 149,00
	incl. btw	€ 119,79	€ 180,29

BLAAS- EN ZUIGMACHINE



- Traploos regelbare snelheid met vario-schakelaar en voorkeuze van 4 maximumsnelheden.
- Verschillende mondstukken beschikbaar voor uiteenlopende toepassingen. Standaard worden 5 mondstukken meegeleverd.
- Kan ook gebruikt worden om lucht weg te zuigen via een speciaal opzetstuk (optioneel).
- Ideaal voor het reinigen van gereedschap en onderdelen. Kan ook gebruikt worden om bijvoorbeeld speelgoed voor op het water op te blazen of snel af te laten.



DAS180RT

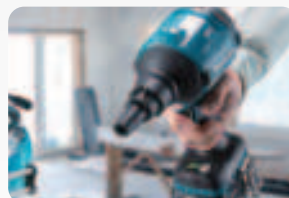

	DAS180Z	DAS180RT	AS001GZ
Spanning	18V	18V	36 V (40Vmax)
Bijgeleverde accu	-	1x BL1850B	-
Max. debiet	1,1 m³/min	1,1 m³/min	0 - 1,3 m³/min
Blaaskracht	2,8 N	2,8 N	2,8 N
Max. onderdruk	93 mbar	93 mbar	103 mbar
Gewicht	1,2 - 1,7 kg	1,2 - 1,7 kg	1,5 - 2,3 kg
Prijs in €	excl. btw	€ 159,00	€ 299,00
	incl. btw	€ 192,39	€ 361,79

MICROGOLFOVEN



- Ideaal om voeding op te warmen op plaatsen waar geen netstroom beschikbaar is.
- Werkt met één 40Vmax accu of twee in parallel.
- Compact, gemakkelijk te transporteren.
- Vermogenniveaus: 350W en 500W
- De verwarmingstijd kan ingesteld worden van 10 seconden tot 20 minuten.
- Met 2x BL4040 en op volle vermogen kunnen ongeveer 5 maaltijden of 8 koppen van 200 ml opgewarmd worden.

		MW001GZ
Spanning		36V (40Vmax)
Bijgeleverde accu's		-
Bijgeleverde lader		-
Inhoud		8 l
Binnenafmetingen		255 x 241 x 120 mm
Uitgangsvermogen		350 W / 500 W
Autonomie (2x BL4040)		350 W: 21 min 500 W: 15 min
Gewicht		9,5 - 12,7 kg
Prijs in €	excl. btw	€ 859,00
	incl. btw	€ 1039,39

VRIES-/ KOELBOX MET VERWARMFUNCTIE



CW004G

- Capaciteit van 29 l
- Uiterst efficiënt en groot koelvermogen door het gebruik van een compressor
- De ruimte kan onderverdeeld worden in twee vakken met elk een eigen temperatuurinstelling, bijvoorbeeld een koel- en vriesvak. Standaard geleverd met binnenbakje en binnenmand
- Het deksel kan aan beide zijden geopend worden of volledig verwijderd voor het gemakkelijk reinigen
- Met beugel om te rollen op de wielen en ook voorzien van inklapbare handvaten zijdelings om gemakkelijk te dragen



CW003GZ



CW004GZ



CW004GZ



CW002GZ01



CW004GZ

	CW003GZ	CW001GZ01	CW004GZ	CW002GZ01
Voeding	36V (40Vmax) XGT / 18V LXT / AC / 12V DC - 24V DC	36V (40Vmax) XGT / 18V LXT / AC / 12V DC - 24V DC	36V (40Vmax) XGT / 18V LXT / AC / 12V DC - 24V DC	36V (40Vmax) XGT / 18V LXT / AC / 12V DC - 24V DC
Inhoud	7 l	20 l	29 l	50 l
Koelen	-18 / -15 / -10 / -5 / 0 / 5 / 10 °C	-18 / -15 / -10 / -5 / 0 / 5 / 10 °C	-18 / -15 / -10 / -5 / 0 / 5 / 10 °C	-18 / -15 / -10 / -5 / 0 / 5 / 10 °C
Verwarmen	30 / 35 / 40 / 45 / 50 / 55 / 60 °C	30 / 35 / 40 / 45 / 50 / 55 / 60 °C	30 / 35 / 40 / 45 / 50 / 55 / 60 °C	30 / 35 / 40 / 45 / 50 / 55 / 60 °C
Autonomie ca.	-18 °C: 5,5 uur, 5 °C: 13,5 uur, 60° C: 5,5 uur (1x BL4040)	-18 °C: 8 uur, 5 °C: 22,5 uur, 60° C: 7 uur (2x BL4040)	-18 °C: 10,0 h, 5 °C: 24,0 h (at 30 °C) 60 °C: 9,0 h (at 0 °C) Dual room mode (left -18 °C, right 5 °C): 9,0 h	-18 °C: 8 uur, 5 °C: 19,5 uur, 60° C: 4,5 uur (2x BL4040)
Afmetingen	456 x 245 x 308 mm	663 x 341 x 372 mm	676 x 345 x 471 mm	867 x 465 x 476 mm
Gewicht	7,9 - 9,4 kg	13,8 - 17,3 kg	17,5 - 20,9 kg	25,6 - 29,0 kg
Prijs in €	excl. btw	€ 639,00	€ 839,00	€ 1.099,00
	incl. btw	€ 773,19	€ 869,99	€ 1.329,79

ACCU BLUETOOTH-SPEAKERS



DMR202
BLUETOOTH-SPEAKER
MET MEDIASPELER
€ 145,00 excl. btw
€ 175,45 incl. btw

LCD-display

USB-
mediaspeler



Equalizer

DMR203
BLUETOOTH-SPEAKER
MET KOPPELFUNCTIE
€ 155,00 excl. btw
€ 187,55 incl. btw

Koppelbaar
per 2: True Wireless Stereo
tot 10: simultaan luisteren

ACCU RADIO'S



					
MR003GZ WERFRADIO XGT/ LXT € 189,00 excl. btw € 228,69 incl. btw	MR004GZ WERFRADIO XGT/ LXT € 225,00 excl. btw € 272,25 incl. btw	MR007GZ WERFRADIO XGT/ LXT € 269,00 excl. btw € 325,49 incl. btw	DMR301 WERFRADIO CXT/LXT € 339,00 excl. btw € 410,19 incl. btw	DMR056 RADIO MET LANTAARN LXT € 159,00 excl. btw € 192,39 incl. btw	MR009GZ RADIO MET LANTAARN XGT € 145,00 excl. btw € 175,45 incl. btw



DMR301 met laadfunctie voor LXT / CXT accu's

GEREEDSCHAPSETS IN KOFFER

Onze favoriet!
E-10883 : 221-delige gereedschapskoffer voor kleine herstellingen



Scan mij voor meer info!



E-10883
GEREEDSCHAPSET
221-DELIG
€ 142,80 excl. btw
€ 172,79 incl. btw

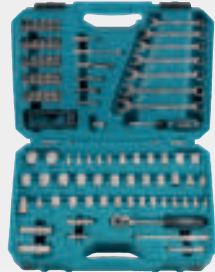

E-06616
GEREEDSCHAPSKOFFER
120-DELIG
€ 113,20 excl. btw
€ 136,97 incl. btw

MAKPAC OPBERGSYSTEEM



- Inclusief 5 types van bakjes : 150x150 mm (1), 150x100 mm (1), 100x100 mm (2), 100x50 mm (3) en 50x50 mm (6)
- Bijkomende inzetbakjes zijn apart te verkrijgen
- Flexibel indeelbaar
- Koppelbaar met Makita Makpacs, Makstors, Makpac trolley TR00000001 en Makpac transportkar P-83886

191X80-2
395 x 295 x 110 mm
2.3 kg
€ 71,80 excl. btw
€ 86,88 incl. btw

MAKSTORS



P-84311 Makstor nr. 3 met 4 lades.



P-84333 Makstor nr. 3 met 6 lades



P-84327 Makstor nr. 3 met 12 lades



P-84349 Makstor nr. 4 met 5 lades

Koppelbaar met alle Makita Makpacs, alsook met Makpac IV koelbox 198253-4, de Makpac trolley TR00000001 en de Makpac transportkar P-83886

De lades van de Makstor zijn flexibel indeelbaar. Standaard worden er bij deze Makstor 8 verdelers / tussenschotten geleverd. De lades zijn voorzien van een vergrendelingssysteem en kunnen gelabeld worden

IDEAAL OM LOS MATERIAAL IN TE BEWAREN ZOALS BOREN EN BITSEN

Omschrijving	Ref.	Indeling	Afmetingen	Prijs excl. btw	Prijs incl. btw
Makstor nr. 3-4	P-84311	4 lades (1 groot / 2 klein / 1 middelgrote)	395 (L) x 295 (B) x 210 (H) mm	€ 162,20	€ 196,26
Makstor nr. 3-12	P-84327	12 kleine lades	395 (L) x 295 (B) x 210 (H) mm	€ 188,00	€ 227,48
Makstor nr. 3-6	P-84333	6 middelgrote lades	396 (L) x 295 (B) x 210 (H) mm	€ 188,00	€ 227,48
Makstor nr. 4-5	P-84349	5 lades (2 groot / 2 klein / 1 middelgrote)	395 (L) x 295 (B) x 320 (H) mm	€ 203,00	€ 245,63

LAMPEN

ZAKLAMPEN CXT



	DEAML103	DEAML104	DEAML105	DEAML106	
Spanning	10,8 V (12Vmax)	10,8 V (12Vmax)	10,8 V (12Vmax)	10,8 V (12Vmax)	
Max. lichtstroom	100 lm	710 lm	190 lm	190 lm	
Verlichtingssterkte op 1 m	50 lx	340 lx (0,5 m, lantaarn)	5500 lx	170 - 4500 lx	
Werkingsduur bij max intensiteit, accu BL1041B	28 u.	5,5 u.	14 u.	12 u.	
Specifieke functionaliteiten	Uiterst compact	Lantaarn (360°) en zaklamp (gericht) USB uitgang	Reflector in 12 posities verstelbaar	Zoom functie	
Afmetingen	77 x 54 x 28 mm	414 x 66 x 132 mm	249 x 66 x 93 mm	271 x 66 x 93 mm	
Gewicht	0,27 - 0,43 kg	0,61 - 0,78 kg	0,53 - 0,7 kg	0,61 - 0,78	
Prijs in €	excl. btw	€ 36,40	€ 96,90	€ 56,10	€ 66,30
	incl. btw	€ 44,04	€ 117,25	€ 67,88	€ 80,22

DEADML105 - DEADML815 - DEAML001G

Reflector 170° kantelbaar in 12 stappen

170°



DEADML104 - DEBDML806 - DEBDML807 - DEAML002G

3 modi: 360° zijdelings licht, 180° zijdelings licht en gericht licht (bovenaan).
USB uitgang Type A: 5V 2,4 A (behalve DEBDML806)

3 MODI

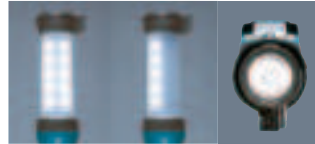

USB uitgang



BEADML810

Ontwerp met laag zwaartepunt zodat de lamp niet kan omvallen



WERFLAMPEN LXT



	DEADML805	DEADML809	BEADML810	DML813	DML814	
Spanning	18 V/ 14,4 V / AC	18 V/ 14,4 V / AC	18 V/ 14,4 V / AC	18 V/ 14,4 V	18 V/ 14,4 V	
Max. lichtstroom	750 lm	10000 lm	5500 lm	3000 lx	3000 lx	
Verlichtingssterkte op 1 m	300 lx	3800 lx	550 lx	1250 lx	1250 lx	
Verlichtingssterkte op 3 m	-	380 lx	70 lx	130 lx	130 lx	
Verlichtingssterkte op 5 m	-	150 lx	25 lx	50 lx	50 lx	
Verlichtingscapaciteit naar voor/zijdelings	-	10 m/10 m	360°, ± 4 m	4,5 m/5,3 m	4,7 m/5,6 m	
Werkingsduur bij max intensiteit, accu BL1850B	8,5 u.	1,4 u (2x BL1850B)	3,5 u.	3 u. (2xBL1850B)	3 u. (2xBL1850B)	
Specifieke functionaliteiten	DC/AC 2 helderheidsniveaus	DC/AC 3 helderheidsniveaus	DC/AC 3 helderheidsniveaus	Geïntegreerd statief	Geïntegreerd statief Met 3 afzonderlijk richtbare lichtunits	
Afmetingen	214 x 261 x 328 mm	249 x 379 x 370 mm	420 x 420 x 787 mm	573 x 658 x 1250-2240 mm	573 x 658 x 1250-2240 mm	
Gewicht	2,3 - 2,7 kg	5,7 - 7,0 kg	13,9 - 15,3 kg	7,2 - 7,9 kg	7,4 - 8,1 kg	
Prijs in €	excl. btw	€ 172,40	€ 418,00	€ 509,00	€ 376,40	€ 396,80
	incl. btw	€ 208,60	€ 505,78	€ 615,89	€ 455,44	€ 480,13

DML813-DML814

Uitschuifbaar van 1250 mm tot 2240 mm
Gemakkelijk opvouwbaar voor transport

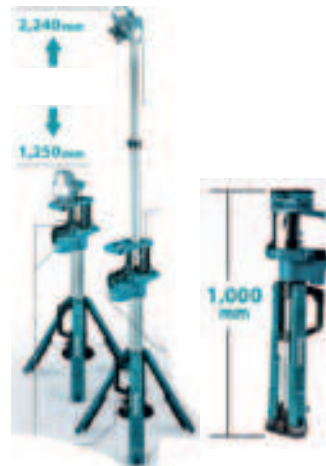

EUAML010GZ

Voeding middels XGT accu's, LXT accu's of netstroom
Tot 4 accu's kunnen tegelijkertijd gemonteerd worden

- Kan tot 80° kantelen zonder om te vallen
- Werkijd bij maximum intensiteit: 8,5 uur (2x BL4050F)
- Beschermingsklasse IP54 (bij werking op accu)

ZAKLAMPEN LXT



NIEUW

	DEADML803	DEBDML186	DEBDML800	DEBDML815	DEBDML808	DEADML816	DECDML807	DEADML817	DEBDML812	EUADML818	
Spanning	18V/14,4V	18V/14,4V	18V/14,4V	18V/14,4V	18V/14,4V	18V/14,4V	18V/14,4V	18V/14,4V	18V/14,4V	18V	
Max. lichtstroom	170 lm	-	100 lm	160 lm	190 lm	500 lm	710 lm (lantaarn)	300 lm	1000 lm (flood)	1700 lumen	
Verlichtingssterkte op 1 m	270 lx (0,5 m)	500 lx	2000 lx	3000 lx	170 - 4500 lx	800 lx (1m)	340 lx (0,5 m, lantaarn)	240 lx (0,5 m)	520 lx (0,5 m flood)	600 lx	
Werkingsduur bij max intensiteit, accu BL1850B	26 u.	83 u.	33 u.	45 u.	26 u.	75 h	23 u.	23 u.	6,5 u (flood)	4 u	
Specifieke functionaliteiten	Batterijhouder met riembevestiging	Met handriem	Hoofdlamp	Reflector in 12 posities kantelbaar	Zoom functie	Reflector draaibaar en kantelbaar	Lantaarn (360°) en zaklamp (gericht) USB uitgang	3 verlichtingsmodi USB uitgang	Modi: spot, flood, spot + flood	3 helderheidsinstellingen	
Afmetingen	133 x 81 x 72 mm	151 x 81 x 61 mm	133 x 76 x 88 mm	256 x 79 x 99 mm	280 x 79 x 10 mm	383 x 79 x 110 mm	414 x 79 x 155 mm	107 x 77 x 50mm	313 x 119 x 115 mm	972 x 80 x 134 cm	
Gewicht	0,56 - 0,92 kg	0,51 - 0,83 kg	0,58 - 0,64 kg	0,26 - 0,93 kg	0,73 - 1,09 kg	0,70 - 1,1 kg	0,72 - 1,1 kg	0,51 - 0,88 kg	1,2 - 1,6 kg	1,7 kg	
Prijs in €	excl. btw	€ 54,10	€ 39,80	€ 51,00	€ 56,10	€ 61,40	€ 61,40	€ 96,90	€ 56,10	€ 152,00	€ 319,90
	incl. btw	€ 65,46	€ 48,16	€ 61,71	€ 67,88	€ 74,29	€ 74,29	€ 117,25	€ 67,88	€ 183,92	€ 387,08

DEADML816 - DEAML006G
De lichtkop is draaibaar, kantelbaar en opvouwbaar



Lichtstroom (Lumen, lm): de hoeveelheid uitgestraald licht per tijdseenheid. Het is een maat voor het vermogen van de lamp.

Verlichtingssterkte (Lux, lx): de lichtstroom per oppervlakte of dus de mate waarin een vlak verlicht wordt. De verlichtingssterkte is afhankelijk van de afstand tot de lichtbron.

Verlichtingscapaciteit: de zone waar de verlichtingssterkte minstens 70 lx is (de verlichtingssterkte die minimaal nodig is om veilig te kunnen werken).

EUADML818 - EUML012G

- LED-lichtbalk met brede verlichting
- Versie EUADML818 voor gebruik met 14,4/18V LXT accu's, versie EUML012G voor XGT
- 3 helderheidsinstellingen: 400 / 800 / 1700 lumen
- Ideaal voor bijvoorbeeld autogarages en pechverhelpingsdiensten. Met de meegeleverde telescopische haak kan het apparaat aan de motorkap of achterdeur van een voertuig bevestigd worden.
- De LED-lichtbalk bestaat uit twee delen en kan in tweeën worden gevouwen.
- De bovenste en onderste helft van de lichtbalk kunnen afzonderlijk ingeschakeld worden
- De verlichtingshoek kan gekozen worden door de lichtbalk te draaien (7 standen)



WERFLAMPEN LXT & XGT



NIEUW

	DEAML003G	DEAML005G	DEAML009G	EUAML010G	EUAML012G	
Spanning	36V (40Vmax) /18V	36V (40Vmax) /18V	36V (40Vmax) /18V	40Vmax /18V / 14,4V / AC	40Vmax	
Max. lichtstroom	1100 lm	3600 lm	10000 lm	5500 lm	1700 lm	
Verlichtingssterkte op 1 m	500 lx	2100 lx	4300 lx	550 lx	600 lx	
Verlichtingssterkte op 3 m	-	230 lx	500 lx	70 lx	-	
Verlichtingssterkte op 5 m	-	90 lx	110 lx	25 lx	-	
Verlichtingscapaciteit naar voor/zijdelings	2,8 m/3,0 m	6,0 m/6,4 m	9,7 m/11,4 m	360°, ± 4 m	3,0 m, 3,3 m	
Werkingsduur bij max intensiteit, accu BL4040	10 u.	3,5 u.	2,4 u.	6,5 u (2x BL4040)	7 u	
Specifieke functionaliteiten	2 helderheidsinstellingen	3 helderheidsinstellingen	3 helderheidsinstellingen	DC/AC 3 helderheidsniveau's	3 helderheidsinstellingen	
Afmetingen	249 x 298 x 280 mm	248 x 309 x 296 mm	248 x 386 x 305 mm	490 x 490 x 814 mm	972 x 85 x 138 mm	
Gewicht	3,7 - 4,7 kg	4,6 - 6,5 kg	6,4 - 9,9 kg	14,4 - 19,2 kg	2,0 kg	
Prijs in €	excl. btw	€ 193,00	€ 280,50	€ 407,00	€ 666,80	€ 349,00
	incl. btw	€ 233,53	€ 339,41	€ 492,47	€ 806,83	€ 422,29

ACCESSOIRES



Statief voor DML805
GM00002283
€ 88,90 excl. btw
€ 107,57 incl. btw



Spanvijs voor DML805
GM00001396
€ 21,20 excl. btw
€ 25,65 incl. btw



Statief voor DML809 / DML811 / ML003G-
GM00002073
€ 198,90 excl. btw
€ 240,67 incl. btw



Prijzen geldig t.e.m. 30/09/2024

ACCU BL1021B
12Vmax 2,0 Ah



197396-9
€ 55,00 excl. btw
€ 66,55 incl. btw

ACCU BL1041B
12Vmax 4,0 Ah



197406-2
€ 70,00 excl. btw
€ 84,70 incl. btw

OPLADER DC10SB

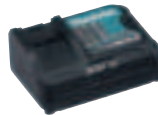

197363-4
€ 65,00 excl. btw
€ 78,65 incl. btw

OPLADER DC18RE



LXT CXT
198720-9
€ 129,00 excl. btw
€ 156,09 incl. btw

BL1050B LI-ION ACCU 5,0
AH 12VMAX

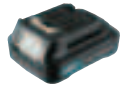

NIEUW
1913G0-9
€ 95,00 excl. btw
€ 114,95 incl. btw

Krachtig Compact Lichtgewicht

POWERPACK 12Vmax
2 x 2,0 Ah

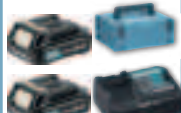

197658-5
€ 159,00 excl. btw
€ 192,39 incl. btw

POWERPACK 12Vmax
2 x 4,0 Ah

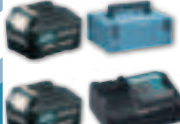

197641-2
€ 189,00 excl. btw
€ 228,69 incl. btw

POWERPACK LXT + CXT



199026-8
€ 279,00 excl. btw
€ 337,59 incl. btw

POWERPACK LXT + CXT

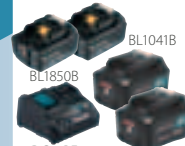

199029-2
€ 429,00 excl. btw
€ 519,09 incl. btw

COMBOPACK CXT



CLX228SAX2



CLX206SAX3



CLX400SAJ1

PROMO

gratis lamp
DEAML103 bij
CLX228SAX2



CLX228SAX2 CLX206SAX3 CLX400SAJ1

Spanning	10,8V	10,8V	10,8V
Bijgeleverde accu's	3x BL1021B	2x BL1020B	3x BL1020B
Lader	DC10SB	DC10SA	DC10SA
Samenstelling	HP333D TD110D	TM30D DF331D	DF331D TD110D HS301D JR103D
Makpac	-	-	1
Prijs in €	excl. btw	€ 305,00	€ 399,00
	incl. btw	€ 369,05	€ 482,79
		€ 445,00	€ 538,45

ACCU BOOR- EN SCHROEFMACHINES

1/4" BITOPNAME



DF032DSAJ



DF033DWAJ

DF033DWAJ DF033DWMJ DF032DSAJ DF032DSMJ

Spanning	10,8 V	10,8 V	10,8 V	10,8 V
Bijgeleverde accu's	2 x BL1021B	2 x BL1040B	2 x BL1020B	2 x BL1040B
Hard koppel	30 Nm	30 Nm	35 Nm	35 Nm
BL-motor	-	-	✓	✓
Gewicht	0,9 kg	0,9 kg	0,9 kg	0,9 kg
Prijs in €	excl. btw	€ 189,00	€ 209,00	€ 235,00
	incl. btw	€ 228,69	€ 252,89	€ 284,35

ACCU BOOR- EN SCHROEFMACHINES



DF331DSMJ



DF333DNX10

DF333DNX10

Accu boor- & schroefmachine	DF333	
Bijgeleverde accu's	2 x BL1850B	
Bijgeleverde accu's	1 x BL1021B	
Lader	DC18RE	
BL-motor	-	
Prijs in €	excl. btw	€ 385,00
	incl. btw	€ 465,85

DF333DWAJ DF333DWMJ DF332DSAJ DF332DSMJ

Spanning	10,8 V	10,8 V	10,8 V	10,8 V
Bijgeleverde accu's	2 x BL1021B	2 x BL1041B	2 x BL1020B	2 x BL1040B
Hard koppel	30 Nm	30 Nm	35 Nm	35 Nm
BL-motor	-	-	✓	✓
Gewicht	1,1 kg	1,1 kg	1,2 kg	1,2 kg
Prijs in €	excl. btw	€ 195,00	€ 225,00	€ 239,00
	incl. btw	€ 235,95	€ 272,25	€ 289,19

ACCU KLOPBOOR- EN SCHROEFMACHINES



HP332DSMJ



HP333DWAJ

HP333DWAJ HP332DSAJ HP332DSMJ

Spanning	10,8 V	10,8 V	10,8 V
Bijgeleverde accu's	2 x BL1021B	2 x BL1020B	2 x BL1040B
Hard koppel	30 Nm	35 Nm	35 Nm
BL-motor	-	✓	✓
Gewicht	1,1 kg	1,1 kg	1,3 kg
Prijs in €	excl. btw	€ 205,00	€ 249,00
	incl. btw	€ 248,05	€ 301,29

ACCU SLAGSCHROEVENDRAAIERS



TD111DSMJ



TD110DSAJ



Assist modus voor het vlot aanzetten bij het schroeven.

TD110DSAJ TD110DSMJ TD111DZJ TD111DSAJ TD111DSMJ

Spanning	10,8 V	10,8 V	10,8 V	10,8 V	10,8 V
Bijgeleverde accu's	2 x BL1020B	2 x BL1040B	0	2 x BL1020B	2 x BL1040B
Max. koppel	110 Nm	110 Nm	135 Nm	135 Nm	135 Nm
BL-motor	-	-	✓	✓	✓
Assist modus	-	-	✓	✓	✓
Gewicht	1,0 kg	1,0 kg	1,0 kg	1,0 kg	1,0 kg
Prijs in €	excl. btw	€ 209,00	€ 239,00	€ 149,00	€ 249,00
	incl. btw	€ 252,89	€ 289,19	€ 180,29	€ 301,29

SCHROEFBITSET (35 STUKS) IMPACT BLACK

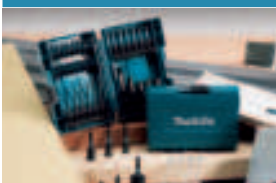

Schroefbitset B-66880

35 stuks Impact Black
 € 45,80 excl. btw
 € 55,42 incl. btw

ACCU BOORHAMERS SDS-PLUS



HR166DSMJ

HR140DSAJ

		HR140DSAJ	HR140DSMJ	HR166DSMJ
Spanning		10,8 V	10,8 V	10,8 V
Bijgeleverde accu's		2 x BL1020B	2 x BL1040B	2 x BL1040B
Slagenergie		1,0 J	1,0 J	1,1 J
Max. Ø beton		14 mm	14 mm	16 mm
BL-motor		-	-	✓
Gewicht		1,9 kg	1,9 kg	1,8 kg
Prijs in €	excl. btw	€ 249,00	€ 295,00	€ 335,00
	incl. btw	€ 301,29	€ 356,95	€ 405,35

ACCU HAAKSE BOORMACHINES

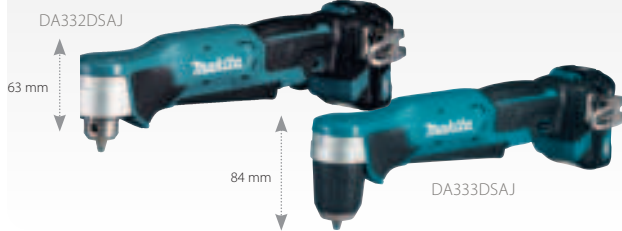

DA332DSAJ

DA333DSAJ

		DA332DSAJ	DA332DSMJ	DA333DSAJ	DA333DSMJ
Spanning		10,8 V	10,8 V	10,8 V	10,8 V
Bijgeleverde accu's		2 x BL1020B	2 x BL1040B	2 x BL1020B	2 x BL1040B
Boorkop		1,5-10 mm	1,5-10 mm	1,5-10 mm	1,5-10 mm
Gewicht		1,2 kg	1,2 kg	1,2 kg	1,2 kg
Prijs in €	excl. btw	€ 215,00	€ 255,00	€ 215,00	€ 255,00
	incl. btw	€ 260,15	€ 308,55	€ 260,15	€ 308,55

ACCU HAAKSE SLAGSCHROEVENDRAAIERS



TL064DZJ



Opname
1/4"

TL065DZJ



Opname
3/8"

		TL064DZJ	TL065DZJ
Spanning		10,8 V	10,8 V
Bijgeleverde accu's		0	0
Toerental		0-2000 t.p.m.	0-2000 t.p.m.
Gewicht		1,2 kg	1,2 kg
Prijs in €	excl. btw	€ 199,00	€ 205,00
	incl. btw	€ 240,79	€ 248,05

ACCU SLAGMOERSLEUTELS



TW141DSMJ

TW161DSMJ

Reverse Auto-stop:
Rotatie stopt automatisch
wanneer de bout of moer is
losgedraaid

		TW140DZJ	TW140DSAJ	TW140DSMJ	TW141DZJ	TW141DSMJ	TW160DZJ	TW160DSAJ	TW160DSMJ	TW161DZJ	TW161DSMJ
Spanning		10,8 V	10,8 V	10,8 V	10,8 V	10,8 V	10,8 V	10,8 V	10,8 V	10,8 V	10,8 V
Bijgeleverde accu's		0	2 x BL1021B	2 x BL1041B	0	2 x BL1041B	0	2 x BL1021B	2 x BL1041B	0	2 x BL1041B
Toerental		0-2600 t.p.m.	0-2600 t.p.m.	0-2600 t.p.m.	0-2600 t.p.m.	0-2600 t.p.m.	0-1300 t.p.m. 0-2400 t.p.m.	0-1300 t.p.m. 0-2400 t.p.m.	0-1300 t.p.m. 0-2400 t.p.m.	0-1300 t.p.m. 0-2400 t.p.m.	0-1300 t.p.m. 0-2400 t.p.m.
Max. koppel		140 Nm	140 Nm	140 Nm	145 Nm	145 Nm	165 Nm	165 Nm	165 Nm	165 Nm	165 Nm
Snelheden		1	1	1	1	1	2	2	2	2	2
Auto-stop functie		-	-	-	-	-	✓	✓	✓	✓	✓
Opname		3/8"	3/8"	3/8"	1/2"	1/2"	3/8"	3/8"	3/8"	1/2"	1/2"
BL-motor		-	-	-	-	-	✓	✓	✓	✓	✓
Gewicht		1,0 kg	1,0 kg	1,0 kg	1,1 kg	1,1 kg	1,0 kg	1,0 kg	1,0 kg	1,1 kg	1,1 kg
Prijs in €	excl. btw	€ 125,00	€ 235,00	€ 265,00	€ 129,00	€ 265,00	€ 159,00	€ 265,00	€ 305,00	€ 165,00	€ 305,00
	incl. btw	€ 151,25	€ 284,35	€ 320,65	€ 156,09	€ 320,65	€ 192,39	€ 320,65	€ 369,05	€ 199,65	€ 369,05

ACCU RATELMOERSLEUTEL



Geleverd met 1/4" & 3/8" opname

Verwijderbare kop laat toe om 13 mm moeren over de lengte van een M8 draadstang te schroeven.



		WR100DZ
Spanning		10,8V
Toerental onbelast		800 t.p.m.
Max. koppel		47,5 Nm
Bijgeleverde accu's		-
Gewicht		1,0 kg
Prijs in €	excl. btw	€ 209,00
	incl. btw	€ 252,89

ACCU NIETMACHINE



ST113DSAJ

Met repeteerfunctie en anti-droogschietmechanisme

		ST113DZJ	ST113DSAJ	ST113DSMJ
Spanning		10,8V	10,8V	10,8V
Bijgeleverde accu's		-	2 x BL1020B	2 x BL1040B
Rugbreedte niet		10 mm	10 mm	10 mm
Ladercapaciteit		150 stuks	150 stuks	150 stuks
Gewicht		1,3 kg	1,3 kg	1,5 kg
Prijs in €	excl. btw	€ 275,00	€ 365,00	€ 399,00
	incl. btw	€ 332,75	€ 441,65	€ 482,79

ACCU PINPISTOOL



PT354DZJ

		PT354DZJ
Spanning		10,8V
Bijgeleverde accu's		-
Draadkaliber		23 Ga
Doorsnede nagel		0,6 mm
Lengte nagel		15-35 mm
Gewicht		2,0 kg
Prijs in €	excl. btw	€ 345,00
	incl. btw	€ 417,45

LUCHTPOMP



MP100DZ

Spanning		10,8V
Bijgeleverde accu's		-
Debiet		10 l/min (bij 2 bar)
Max. druk		8,3 bar
Gewicht		1,2 kg
Prijs in €	excl. btw	€ 89,00
	incl. btw	€ 107,69

ACCU SCHUUR-/POLIJSTMACHINE 75 MM



- Geleverd met adapter voor Roloc™ voor schuurtoepassingen en een velcro steunschijf voor het polijsten
- Ideaal voor oppervlaktebehandeling en voor het polijsten van kleine oppervlakken



		PV301DZJ	PV301DSAEJ
Spanning		10,8V	10,8V
Bijgeleverde accu's		-	2x BL1021B
Capaciteit polijsten		80 mm	80 mm
Capaciteit schuren		50 mm	50 mm
Toerental polijsten		0-2800 min ⁻¹	0-2800 min ⁻¹
Toerental schuren		0-9500 min ⁻¹	0-9500 min ⁻¹
Gewicht		1,1 kg	1,1 kg
Prijs in €	excl. btw	€ 275,00	€ 375,00
	incl. btw	€ 332,75	€ 453,75

ACCU CIRKELZAAG 85 MM



HS301DSAJ

		HS301DSAJ	HS301DSMJ
Spanning		10,8V	10,8V
Bijgeleverde accu's		2 x BL1020B	2 x BL1040B
Max. zaagdiepte bij (90°)		25,5 mm	25,5 mm
Ø Zaagblad		85 mm	85 mm
Gewicht		1,6 kg	1,6 kg
Prijs in €	excl. btw	€ 219,00	€ 255,00
	incl. btw	€ 264,99	€ 308,55

ACCU TEGELSNIJDER 85 MM



CC301DSMJ



		CC301DZJ	CC301DSMJ
Spanning		10,8V	10,8V
Bijgeleverde accu's		-	2 x BL1040B
Zaagdiepte (90°)		25,5 mm	25,5 mm
Ø Zaagblad		85 mm	85 mm
Gewicht		1,9 kg	1,9 kg
Prijs in €	excl. btw	€ 169,00	€ 299,00
	incl. btw	€ 204,49	€ 361,79

ACCU DRAADSTANGKNIPPER



Voor gebruiksklaar afkorten zonder vonken!

SC103DZJ

Spanning		10,8V
Bijgeleverde accu's		-
Afkorten		Mobiel
Snijscapaciteit		M6 - M8 - M10
Inbegrepen mes		M8, M10
Gewicht		2,7 kg
Prijs in €	excl. btw	€ 639,00
	incl. btw	€ 773,19

ACCU MULTICUTTER



CP100DZJ

Spanning		10,8V
Bijgeleverde accu's		-
Snijscapaciteit		6 mm
Gewicht		0,72 kg
Prijs in €	excl. btw	€ 89,00
	incl. btw	€ 107,69

ACCU GIPSZAAG



SD100DZJ

Spanning		10,8V
Bijgeleverde accu's		-
Slaglengte		6 mm
Snijscapaciteit		30 mm
Gewicht		1,5 kg
Prijs in €	excl. btw	€ 245,00
	incl. btw	€ 296,45

ACCU DECOUPEERZAGEN

10.8v CXT



JV102DSAJ



JV103DSAJ

	JV101DSAJ	JV102DZJ	JV102DSAJ	JV102DSMJ	JV103DZJ	JV103DSAJ	JV103DSMJ
Spanning	10,8V	10,8V	10,8V	10,8V	10,8V	10,8V	10,8V
Bijgeleverde accu's	2 x BL1020B	0	2 x BL1020B	2 x BL1040B	0	2 x BL1020B	2 x BL1040B
Aantal zaagbewegingen	0-2900 /min	800-3000 /min	800-3000 /min	800-3000 /min	800-3000 /min	800-3000 /min	800-3000 /min
Max. capaciteit hout	65 mm	90 mm	90 mm	90 mm	90 mm	90 mm	90 mm
BL-motor	-	✓	✓	✓	✓	✓	✓
Gewicht	1,8 kg	1,8 kg	1,8 kg	1,8 kg	1,8 kg	1,8 kg	1,8 kg
Prijs in €	excl. btw	€ 235,00	€ 179,00	€ 279,00	€ 309,00	€ 179,00	€ 279,00
	incl. btw	€ 284,35	€ 216,59	€ 337,59	€ 373,89	€ 216,59	€ 337,59

ACCU RECIPROZAAG

10.8v CXT



JR103DSAJ

	JR103DSAJ	JR103DSMJ
Spanning	10,8V	10,8V
Bijgeleverde accu's	2 x BL1020B	2 x BL1040B
Max. zaagcapaciteit hout/stalen buis	50 mm	50 mm
Gewicht	1,3 kg	1,5 kg
Prijs in €	excl. btw	€ 229,00
	incl. btw	€ 277,09

ACCU MULTITOOl

10.8v CXT



TM30DSAJX3

Spanning	10,8V	
Bijgeleverde accu's	2 x BL1020B	
Oscillatiehoek	3,2°	
Oscillatiefrequentie	6000-20000 min ⁻¹	
Opname	OIS, Starlock	
Gewicht	1,1 kg	
Prijs in €	excl. btw	€ 335,00
	incl. btw	€ 405,35

ACCU KITPISTOOL

CXT 10.8v



CG100DSAEA

CG100DSAEB

CG100DSAEB met aluminium kokerhouder 600 ml (voor worsten of kit in bulkverpakking)

	CG100DSAEA	CG100DSAEB
Spanning	10,8V	10,8V
Bijgeleverde accu's	2 x BL1020B	2 x BL1020B
Max. extrusiekracht	5000 N	5000 N
Max. extrusiesnelheid	0-28 mm/s	0-28 mm/s
Prijs in €	excl. btw	€ 325,00
	incl. btw	€ 393,25

STEELOFZUIGERS MET GEÏNTEGREERDE ACCU



	CL114DWIX	CL117FDX2	CL117FDX5	CL117FDX8
Spanning	10,8 V	10,8 V	10,8 V	10,8 V
Bijgeleverde accu's	Geïntegreerd	Geïntegreerd	Geïntegreerd	Geïntegreerd
Max. debiet	1,4 m³/min	1,0 m³/min	1,0 m³/min	1,0 m³/min
Max. onderdruk	34 mbar	50 mbar	50 mbar	50 mbar
Stofopvang	Stofzak	Capsule	Capsule	Capsule
Klikvergrendeling	✓	✓	✓	✓
Kleur	Beige	Turquoise	Groen	Purper
Promo	-	-	-	-
Gewicht	0,94 kg	1,0 kg	1,0 kg	1,0 kg
Prijs in €	excl. btw	€ 119,00	€ 125,00	€ 125,00
	incl. btw	€ 143,99	€ 151,25	€ 151,25

CYCLONMODULE

- ✓ Het grove stof wordt van het fijne stof gescheiden.
- ✓ Stofzak of capsule voor het fijn stof tot 80 % minder vaak ledigen!
- ✓ Het reservoir van de module is zeer gemakkelijk te ledigen en uit te wassen.

Gemakkelijk te ledigen

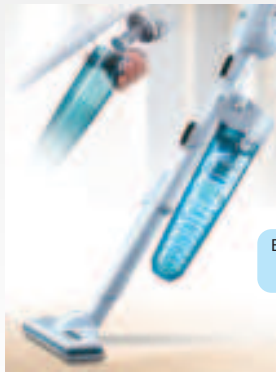

Extra opvangcapaciteit **400 ml**



191D71-3

Ref.	Kleur	Prijs excl. btw	Prijs incl. btw
Cyclonmodule met klikvergrendeling			
191D71-3	wit	€ 39,90	€ 48,28
191D73-9	zwart	€ 39,90	€ 48,28
Cyclonmodule zonder klikvergrendeling			
199491-1	wit	€ 34,20	€ 41,38
191d75-5	zwart	€ 34,20	€ 41,38

OPTIONELE ACCESSOIRES

Ref.	Kleur	Prijs excl. btw	Prijs incl. btw
Muurbevestiging 199971-7			
199971-7		€ 13,70	€ 16,58
Vloerzuigmond tapijt 198527-3			
198527-3		€ 17,10	€ 20,69
Kierzuigmond lang 198990-0			
198990-0		€ 6,80	€ 8,23
Ronde borstel 198553-2			
198553-2		€ 10,30	€ 12,46
Steeleofzuigerstandaard 1911L1-0			
1911L1-0		€ 37,20	€ 45,01

NIEUW

STEELOFZUIGERS CXT/ LXT



PROMO:

DCL182Z: gratis cyclon 199491-1 + muurbevestiging
DCL280FZW: gratis cyclon 191D71-3 + muurbevestiging

DCL284, DCL285 & DCL286:

- Nieuwe brushless motor levert hoge zuigkracht.
- Laag geluidsniveau door vernieuwd ontwerp van luchtuitlaat.
- De DCL286 heeft een ingebouwde cyclonmodule: deze vangt grove stofdeeltjes op waardoor de optimale zuigkracht langer behouden blijft.



	CL102DW	CL107FDZW	DCL180ZB	DCL182Z	DCL280FZW	DCL284FZB	DCL284FRFB	DCL285FZ	DCL285FRF	DCL286FZW	DCL286FRFW
Spanning	10,8 V	10,8 V (CXT)	18 V (LXT)	18 V (LXT)	18 V (LXT)	18 V (LXT)	18 V (LXT)	18 V (LXT)	18 V (LXT)	18 V (LXT)	18 V (LXT)
Bijgeleverde accu's	1 x BL1013	-	-	-	-	-	1x BL1830	-	1x BL1830	-	1x BL1830
Max. debiet	0,9 m³/min	1,4 m³/min	1,4 m³/min	1,4 m³/min	1,5 m³/min	1,2 m³/min	1,2 m³/min	1,2 m³/min	1,2 m³/min	1,0 m³/min	1,0 m³/min
Max. onderdruk	23 mbar	50 mbar	42 mbar	54 mbar	60 mbar	180 mbar	180 mbar	180 mbar	180 mbar	180 mbar	180 mbar
Stofopvang	Stofzak	Stofzak	Capsule	Stofzak	Capsule	Capsule	Capsule	Stofzak	Stofzak	Cyclon	Cyclon
Klikvergrendeling	-	-	-	-	✓	✓	✓	✓	✓	✓	✓
BL motor	-	-	-	-	✓	✓	✓	✓	✓	✓	✓
Kleur	Wit	wit	Zwart	Blauw	Wit	zwart/turquoise	zwart/turquoise	Blauw	Blauw	Wit	Wit
Gewicht	1,1 kg	1,1 - 1,3 kg	1,2 kg	1,3 kg	1,2 - 1,6 kg	1,3 - 1,6 kg	1,3 - 1,6 kg	1,4 - 1,7 kg	1,4 - 1,7 kg	1,6 - 1,9 kg	1,6 - 1,9 kg
Prijs in €	excl. btw	€ 99,00	€ 79,00	€ 75,00	€ 79,00	€ 149,00	€ 155,00	€ 279,00	€ 165,00	€ 289,00	€ 169,00
	incl. btw	€ 119,79	€ 95,59	€ 90,75	€ 95,59	€ 180,29	€ 187,55	€ 337,59	€ 199,65	€ 349,69	€ 204,49

XGT STEELSTOFZUIGERS



CL002GD205

CL001GD208

CL002GD212

CL003GZ04

		CL001GZ05	CL001GD208	CL002GZ03	CL002GD205	CL002GZ07	CL002GD212	CL003GZ04
Spanning		40Vmax	40Vmax	40Vmax	40Vmax	40Vmax	40Vmax	40Vmax
Bijgeleverde accu's		-	2x BL4025	-	2x BL4025	-	2x BL4025	-
Bijgeleverde lader		-	DC40RA	-	DC40RA	-	DC40RA	-
Max. debiet		1,2 m³/min	1,2 m³/min	1,2 m³/min	1,2 m³/min	1,2 m³/min	1,2 m³/min	1,0 m³/min
Max. onderdruk		210 mbar	210 mbar	210 mbar	210 mbar	210 mbar	210 mbar	200 mbar
Stofopvang		Capsule	Capsule	Stofzak	Stofzak	Stofzak	Stofzak	Cycloon-capsule
Klikvergrendeling		✓	✓	✓	✓	✓	✓	✓
Kleur		Turquoise	Turquoise	Zwart	Zwart	Wit	Wit	Zwart
Gewicht		1,7 - 2,3 kg	1,7 - 2,3 kg	1,7 - 2,3 kg	1,7 - 2,3 kg	1,7 - 2,3 kg	1,7 - 2,3 kg	1,9 - 2,5 kg
Prijs in €	excl. btw	€ 165,00	€ 525,00	€ 159,00	€ 519,00	€ 159,00	€ 519,00	€ 179,00
	incl. btw	€ 199,65	€ 635,25	€ 192,39	€ 627,99	€ 192,39	€ 627,99	€ 216,59

CLEANING COMBOPACK



CLX245SAX1

Spanning	10,8V	
Meegeleverde accu's	1 x BL1021B	
Lader	DC10SB	
Steelstofzuiger	CL108FDZW	
Blaas-/ zuigmachine	UB100DZ	
Gereedschapstas	✓	
Prijs in €	excl. btw	€ 229,00
	incl. btw	€ 277,09

ACCU CYCLOONSTOFZUIGER



DCL501Z

DCL501Z

Spanning	18V	
Bijgeleverde accu's	0	
Max. debiet	1,3 m³/min	
Max. onderdruk	66 mbar	
Gewicht	3,1 kg	
Prijs in €	excl. btw	€ 349,00
	incl. btw	€ 422,29

Technologie

Auto-start wireless system

AWS
Auto - start Wireless System

Geniet van stofvrij werken met AWS!

Bij het starten van de accu-machine wordt de stofafzuiging automatisch geactiveerd d.m.v. een Bluetooth verbinding. Wanneer het verbonden toestel uitgeschakeld wordt, gaat de stofzuiger weer in stand-by modus. Sommige accustofzuigers zoals VC009 of DVC867 hebben AWS reeds standaard ingebouwd en kunnen dus rechtstreeks communiceren met AWS-compatibele gereedschappen.

Via de optionele adapter WUT02U kunnen nu ook stofzuigers op netstroom draadloos aangestuurd worden, ongeacht het merk. De enige vereiste is dat de stofzuiger met een startautomatiek uitgerust is.



Bluetooth unit 198900-7
€ 62,50 excl. btw
€ 75,60 incl. btw



AWS-compatibele stofzuiger



DVC867L



Stofzuiger met startautomatiek



+



Adapter WUT02U 199773-1
€ 205,80 excl. btw
€ 249,00 incl. btw



ACCU BLAAS- EN ZUIGMACHINE

12V max
LITHIUM-ION

18V
LITHIUM-ION

UB101DZ & DUB186:
uitvoering met lange pijp,
ideaal om laag bij de grond
te blazen.

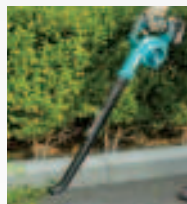

DUB186Z

DUB185Z

	UB100DZ	UB101DZ	DUB185Z	DUB186Z
Spanning	10,8V	10,8V	18V	18V
Max. luchtsnelheid	75 m/s	65 m/s	98 m/s	68 m/s
Max. debiet	2,6 m³/min	2,6 m³/min	3,2 m³/min	3,2 m³/min
Gewicht	1,4 kg	1,4 kg	1,6 kg	1,6 kg
Prijs in €	excl. btw	€ 95,00	€ 65,29	€ 95,00
	incl. btw	€ 114,95	€ 79,00	€ 114,95

BLAAS- EN ZUIGMACHINE



Multifunctionele schakelaar
met snelheidsinstelling

	UB1103	
Vermogen	600 W	
Max. luchtsnelheid	91 m/s	
Max. debiet	4,1 m³/min	
Gewicht	2,0 kg	
Prijs in €	excl. btw	€ 159,00
	incl. btw	€ 192,39

ACCU RUGGEDRAGEN STOFZUIGERS



DVC660

DVC665



DVC660
Uitvoering speciaal voor schoonmaak,
geleverd met diverse accessoires.

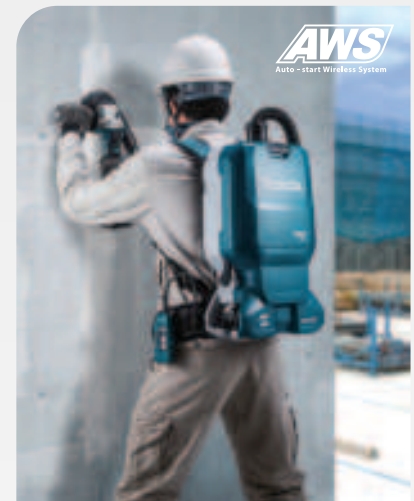

DVC665
Uitvoering voor stofafzuiging in
combinatie met machines.



HEPA-filter

Als hoofdfilter wordt een HEPA-filter gebruikt die zeer fijne stofdeeltjes effectief tegenhoudt. De filter kan tot 99,97 % van de deeltjes tussen 0,3 en 1 µm filteren, waardoor de uitgeblazen lucht zeer zuiver is.



Filterreiniging

Door de trillingen van het stappen of het manueel indrukken van de hendel wordt het fijn stof van de papierfilter geschud. Daardoor blijft de zuigkracht langer optimaal bij het opzuigen van fijn stof.



	DVC265ZXU	DVC261ZX11	DVC660Z	DVC665ZX1U
Spanning	2 x 18V	2 x 18V	2 x 18V	2 x 18V
Max. debiet	1,8-2,2 m³/min	1,8-2,2 m³/min	1,8-2,2 m³/min	1,8-2,2 m³/min
Max. onderdruk	110 mbar	110 mbar	110 mbar	110 mbar
Uitvoering	Stofafzuiging machines	Schoonmaak	Schoonmaak	Stofafzuiging machines
Capaciteit stofzak	2l	2l	6l	6l
AWS	✓	-	-	✓
Gewicht	3,9 kg	3,8 kg	6,1 kg	6,1 kg
Prijs in €	excl. btw	€ 375,00	€ 335,00	€ 375,00
	incl. btw	€ 453,75	€ 405,35	€ 453,75

ACCU RUGGEDRAGEN STOFZUIGERS



VC011G



VC008G



VC009G

(Geleverd zonder batterijen en zonder oplader)



VC011G

Zeer comfortabel harnas

VC008G-VC009G

- Hogere zuigkracht dankzij de 40Vmax accutechnologie
- Geluidsarm door een hertekend design van de luchtuitlaat en gebruik van geluidsabsorberend materiaal.
- VC008G wordt standaard geleverd met accessoires voor schoonmaakt toepassingen.
- VC009GZ01 wordt geleverd met twee zuigslangen en hulpstukken voor stofafzuiging in combinatie met machines.

VC011G

- Verhoogde autonomie dankzij 2 x XGT accu's parallel
- Werktijd met 2 x BL4050F: tot 260 min (min vermogen) en 40 min (max vermogen).
- Hoog luchtdebiet en hoge zuigkracht
- Stille werking
- Automatisch zelfreinigende filter
- Zeer comfortabel harnas

NIEUW

	VC008GZ	VC009GZ01	VC011GZ
Spanning	40Vmax	40Vmax	40Vmax
Max. debiet	2,4 m³/min	1,9 m³/min	2,4 m³/min
Max. onderdruk	180 mbar	180 mbar	200 mbar
Uitvoering	Schoonmaak	Stofafzuiging machines	Schoonmaak
Capaciteit stofzak	2,0l	2,0l	6,0l
AWS	-	✓	-
Gewicht	4,1 - 5,3 kg	4,1 - 5,3 kg	6,4 - 9,5 kg
Prijs in €	excl. btw	€ 369,00	€ 389,00
	incl. btw	€ 446,49	€ 470,69



VC011GZ

ACCU RECHTOPSTAANDE STOFZUIGER

18V + 18V → 36V

DVC560 - VC010G

- Zeer wendbare alles-in-één stofzuiger (geen netsnoer of zuigslang)
- Hoge stofopname door de combinatie van roterende borstel en stofzuigsysteem, ideaal voor hoogpollige en laagpollige tapijten.



Instelbare hoogte van de borstel



Geïntegreerde aluminium pijp om moeilijk bereikbare plaatsen te reinigen

de behuizing kan tot 90° scharnieren om gemakkelijk onder meubilair te stofzuigen.

VC010G

- Verhoogde stofopname
- Bredere vloerborstel
- 5-traps hoogteverstelling van de borstelrol
- Vloerborstel met zeer laag profiel



DVC560Z



VC010GZ

NIEUW

DVC560Z VC010GZ

Spanning		2 x 18V	40Vmax
Bijgeleverde accu's		-	-
Max. debiet		1,9 m³/min	1,8 m³/min
Max. onderdruk		120 mbar	150 mbar
Gewicht		8,3 - 9,0 kg	8,0 - 9,2 kg
Prijs in €	excl. btw	€ 479,00	€ 615,00
	incl. btw	€ 579,59	€ 744,15



ACCU COMPACTE STOFZUIGER

LXT 18V LITHIUM-ION



Inclusief draagriem, vloerzuigmond & kierzuigmond

DVC750LZX1

Spanning		18V
Bijgeleverde accu's		0
Max. debiet		1,4 m³/min
Max. onderdruk		64 mbar
Gewicht		4,2 kg
Prijs in €	excl. btw	€ 219,00
	incl. btw	€ 264,99

ACCU COMPACTE STOFZUIGER

12V max LITHIUM-ION

18V LITHIUM-ION

IDEAAL VOOR DE AUTO



DCL184Z

Met blaasfunctie

Inclusief accessoires

CL121DZJ DCL184Z

Spanning		10,8V	18V
Bijgeleverde accu's		-	-
Lader		-	-
Max. debiet		1,3 m³/min	1,3 m³/min
Max. onderdruk		44 mbar	47 mbar
Gewicht		1,7	2,1 kg
Prijs in €	excl. btw	€ 135,00	€ 129,00
	incl. btw	€ 163,35	€ 156,09

Zuigmond voor matten



Zuigmond voor zetels



Rubberen zuigmond

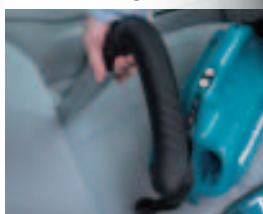

Zachte borstel

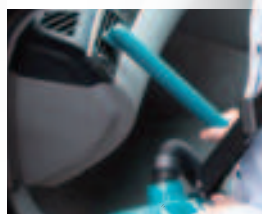

Blaasmond



ACCU ROBOTSTOFZUIGERS



DRC200

- Verschillende sensoren voor obstakel- en grensdetectie
- Patroonmodus voor grote vloeroppervlakken met weinig obstakels, zoals een magazijn of een lange gang
- Willekeurige modus voor vloeroppervlakken met veel obstakels, zoals in een kantoor.
- Door middel van grenstape kan de gebruiker de zone afbakenen waarbinnen de robot mag werken.
- Modi "alleen borstelen" of "stofzuigen + borstelen"
- Bediening op het toestel zelf of met bijgeleverde afstandsbediening
- Werkt op één 18 V accu of twee in parallel. De accu's moeten uit het toestel verwijderd worden om op te laden.



DRC200PTJ

OPPERVLAKTE
TOT 500 m²

Patroonmodus

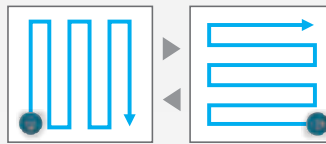

Willekeurige modus

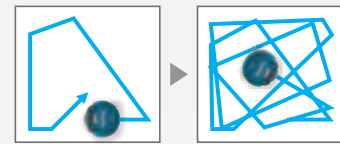

OPPERVLAKTE
TOT 600 m²



DRC300Z



De camera maakt beelden van het plafond ter ondersteuning van de navigatie



DRC300

- Kan ruimtes in kaart brengen door gebruik te maken van LiDAR module en beeldcamera. Tot 5 ruimtes kunnen in het geheugen bewaard worden. Dankzij de intelligente positiebepaling kan een ruimte efficiënter gereinigd worden en kan de machine ook automatisch terugkeren naar het beginpunt
- Verschillende sensoren voor obstakel- en grensdetectie
- Modi "alleen borstelen" of "stofzuigen + borstelen"
- Bediening op het toestel zelf, met de afstandsbediening of met de smartphone app (Wifi verbinding)
- Via de smartphone app kunnen de bewaarde kaarten weergegeven en geoptimaliseerd worden (bv. het definiëren van verboden zones) en kan ook schoonmaakstatus en -historiek gecontroleerd worden
- Werkt op één 18 V accu of twee in parallel. De accu's moeten uit het toestel verwijderd worden om op te laden.

DRC200Z DRC200PTJ DRC300Z

Spanning		18 V (één of 2 in parallel)		
Bijgeleverde accu's		-	2 x BL1850B	-
Lader		-	DC18RD	-
Capaciteit opvangbak		2,5 l	2,5 l	3,0 l
Max. registreerbare oppervlakte		-	-	10000 m ²
Max. snelheid		0,3 m/s	0,3 m/s	0,3 m/s
Navigatie		Willekeurig of vast patroon	Willekeurig of vast patroon	Intelligent op basis van kaart
LiDAR sensor		-	-	✓
Camera		-	-	✓
Configuratie en besturing met app		-	-	✓
Afbakenen van verboden zones		Tape	Tape	Tape of via app
Terugkeren naar beginpunt		-	-	✓
Gewicht		6,8 - 7,8 kg	6,8 - 7,8 kg	9,6 - 10,6 kg
Prijs in €	excl. btw	€ 915,00	€ 1.179,00	€ 1.999,00
	incl. btw	€ 1.107,15	€ 1.426,59	€ 2.418,79

ACCU STOFZUIGERS L-KLASSE LXT



DVC155LZX2



DVC867LZX4



DVC157LZX3



	DVC150LZ	DVC155LZX2	DVC867LZX4	DVC157LZX3	
Spanning	2 x 18 V / 230 V	2 x 18 V	2 x 18 V	2 x 18 V	
Bijgeleverde accu	-	-	-	-	
Kuipvolume	15 l	15 l	8 l	15 l	
Type	Nat & Droog	Nat & Droog	Droog	Droog	
Filter	Textielfilter	Textielfilter	HEPA	HEPA	
Max. debiet	2,1 / 3,6 m ³ /min	2,1 m ³ /min	2,4 m ³ /min	2,4 m ³ /min	
Max. onderdruk	90 / 240 mbar	110 mbar	110 mbar	110 mbar	
AWS	-	-	✓	✓	
Gewicht	8,9 kg	7,9 kg	7,8 kg	8,0 kg	
Prijs in €	excl. btw	€ 579,00	€ 449,00	€ 579,00	€ 599,00
	incl. btw	€ 700,59	€ 543,29	€ 700,59	€ 724,79

ACCU STOFZUIGERS L-KLASSE XGT



VC003GLZ

VC004GLZ

VC005GLZ



- Voeding met twee 40Vmax accu's in parallel.
- Hoge zuigkracht dankzij hoger vermogen en verbeterde koeling.
- Met telescopische steel (VC001G/VC003G/VC005G)
- Vloerborstel met laag profiel en verstelling voor harde vloer of tapijt (VC001G/VC003G/VC005G).
- VC005G: hoge wendbaarheid en stabiliteit door extra grote wielen achteraan.

Toepassing:

- VC001G / VC003G: voor algemeen droog en nat gebruik (schoonmaak).
- VC002G/VC004G: ideaal voor stofafzuiging van machines (met HEPA filter en AWS).
- VC005G: voor algemeen droog gebruik (schoonmaak).

	VC001GLZ	VC003GLZ	VC002GLZ01	VC004GLZ01	VC005GLZ	
Spanning	36 V (40Vmax)	36 V (40Vmax)	36 V (40Vmax)	36 V (40Vmax)	36 V (40Vmax)	
Bijgeleverde accu's	-	-	-	-	-	
Type	Droog/Nat	Droog/Nat	Droog	Droog	Droog	
Capaciteit	8 l	15 l	8 l	15 l	8 l	
Max. debiet	3,2 m ³ /min	3,2 m ³ /min	1,8 m ³ /min	1,8 m ³ /min	2,8 m ³ /min	
Max. onderdruk	230 mbar	230 mbar	230 mbar	230 mbar	230 mbar	
Filter	Textielfilter	Textielfilter	HEPA	HEPA	Textielfilter	
AWS	-	-	✓	✓	-	
Gewicht	8,1 - 10 kg	8,1 - 10 kg	8,3 - 10,2 kg	8,3 - 10,2 kg	7,9 - 9,8 kg	
Prijs in €	excl. btw	€ 469,00	€ 489,00	€ 599,00	€ 619,00	€ 499,00
	incl. btw	€ 567,49	€ 591,69	€ 724,79	€ 748,99	€ 603,79

WAT BETEKEN L-, M- OF H-KLASSE?

Stofzuigers voor professioneel gebruik worden volgens EN60335-2-69 ingedeeld in risicoklassen:

L-klasse (Low risk) stofzuigers mogen gebruikt worden voor alle stof waarvan de toelaatbare blootstellingswaarde groter is dan 1 mg/m^3 . Deze stofzuigers laten minder dan 1 % van het opgezogen stof door.

M-klasse (Medium risk) stofzuigers mogen gebruikt worden voor alle stof waarvan de toelaatbare blootstellingswaarde groter is dan $0,1 \text{ mg/m}^3$. Deze stofzuigers laten minder dan 0,1 % van het opgezogen stof door en voldoen bovendien aan een aantal bijkomende eisen, waaronder permanente debietcontrole en stofarme lediging.

H-klasse stofzuigers (High risk) moeten gebruikt worden voor stoffen waarvan de max. blootstellingswaarde $< 0,1 \text{ mg/m}^3$ bedraagt. Deze stofzuigers laten minder dan 0,005 % van het opgezogen stof door en moeten ook voldoen aan een aantal bijkomende eisen, zoals permanente debietcontrole en stofarme lediging.

Opgelet: stofzuigers zonder aanduiding van de stofklasse volgens EN60335-2-69 bieden geen enkele garantie op het vlak van persoonlijke veiligheid en zijn derhalve niet geschikt voor professioneel gebruik.

ACCU STOFZUIGERS L-KLASSE XGT



VC007GL, VC006GM: dubbel filtersysteem met automatisch zelfreinigende filter, zonder zuigkrachtonderbreking



- Accu stofzuiger met hoge zuigkracht, vergelijkbaar met model op netstroom
- Stofklasse L, met HEPA-filter
- Nat en droog gebruik, uitgerust met waterniveausensor en waterafvoer
- Automatisch zelfreinigende filter met dubbel filtersysteem
- Inclusief slang 28 mm en 38 mm, gebogen buis en vloerzuigmond
- AWS: de stofzuiger kan automatisch aangestuurd worden door AWS-compatibele powertools

VC007GLZ01

Spanning	72 V (80Vmax)	
Bijgeleverde accu's	-	
Lader	-	
Kuipvolume	40 l	
Type	nat/droog	
Filterklasse	L (HEPA)	
Max. debiet (38 mm slang)	3,7 m ³ /min	
Max. debiet (28 mm slang)	2,0 m ³ /min	
Max. onderdruk	180 mbar	
Gewicht	18,3 - 20,7 kg	
Prijs in €	excl. btw	€ 1.219,00
	incl. btw	€ 1.474,99

ACCU STOFZUIGERS M-KLASSE XGT



De VG006GM heeft een instelling van de slangdiameter en waarschuwingszoemer voor te lage luchtstroom.



- Accu stofzuiger met hoge zuigkracht, vergelijkbaar met model op netstroom
- Stofklasse M
- Nat en droog gebruik, uitgerust met waterniveausensor en waterafvoer
- Automatisch zelfreinigende filter met dubbel filtersysteem
- Inclusief slang 28 mm en 38 mm, gebogen buis en vloerzuigmond
- AWS: de stofzuiger kan automatisch aangestuurd worden door AWS-compatibele powertools

VC006GMZ01

Spanning	72 V (80Vmax)	
Bijgeleverde accu's	-	
Lader	-	
Kuipvolume	40 l	
Type	nat/droog	
Filterklasse	M	
Max. debiet (38 mm slang)	3,7 m ³ /min	
Max. debiet (28 mm slang)	2,0 m ³ /min	
Max. onderdruk	180 mbar	
Gewicht	18,4 - 20,8 kg	
Prijs in €	excl. btw	€ 1.279,00
	incl. btw	€ 1.547,59

STOFZUIGERS L-KLASSE

Klasse L
VC2512L

Klasse L
VC2000L

Klasse L
VC3011L

Klasse L
VC3012L

INCLUSIEF
1 SET ACCESSOIRES



STOFZUIGERS L-, M- EN H-KLASSE

Klasse L
VC2510LX1

Klasse L
VC3210LX1

Klasse M
VC3211MX1

Klasse H
VC3211HX1

INCLUSIEF
1 SET ACCESSOIRES



Automatische filterreiniging
zonder zuigkrachtonderbreking.

Automatische filterreiniging
zonder zuigkrachtonderbreking.

STOFZUIGERS L- EN M-KLASSE

Klasse M
VC2211MX1

Klasse L
VC4210LX

Klasse M
VC4210MX

INCLUSIEF
1 SET ACCESSOIRES



Automatische filterreiniging
zonder zuigkrachtonderbreking.

Automatische filterreiniging
zonder zuigkrachtonderbreking.

Automatische filterreiniging
zonder zuigkrachtonderbreking.



	VC2000L	VC2012L	VC2512L	VC3011L	VC3012L	VC3012M	VC2211MX1
Nominaal vermogen	1000 W	1100 W	1100 W	1000 W	1200 W	1200 W	1050 W
Max. debiet	3,6 m³/min	3,6 m³/min	3,6 m³/min	3,6 m³/min	3,7 m³/min	3,7 m³/min	3,5 m³/min
Max. onderdruk	210 mbar	210 mbar	210 mbar	210 mbar	230 mbar	230 mbar	220 mbar
Bruto kuipvolume	20 l	19 l	23 l	30 l	30 l	30 l	22 l
Gewicht	7,5 kg	7,3 kg	6,3 kg	10,5 kg	10 kg	10 kg	16,3 kg
Prijs in €	excl. btw	€ 175,00	€ 235,00	€ 205,00	€ 269,00	€ 449,00	€ 749,00
	incl. btw	€ 211,75	€ 284,35	€ 248,05	€ 325,49	€ 543,29	€ 906,29

	VC2510LX1	VC3210LX1	VC3211MX1	VC3211HX1	VC4210LX	VC4210MX	
Nominaal vermogen	1050 W	1050 W	1050 W	1050 W	1200 W	1200 W	
Max. debiet	3,5 m³/min	3,5 m³/min	3,5 m³/min	3,5 m³/min	4,5 m³/min	4,5 m³/min	
Max. onderdruk	220 mbar	220 mbar	220 mbar	220 mbar	250 mbar	250 mbar	
Bruto kuipvolume	32 l	40 l	40 l	40 l	42 l	42 l	
Gewicht	10,5 kg	14,5 kg	16,9 kg	16,9 kg	15 kg	15 kg	
Prijs in €	excl. btw	€ 469,00	€ 549,00	€ 799,00	€ 835,00	€ 669,00	€ 759,00
	incl. btw	€ 567,49	€ 664,29	€ 966,79	€ 1.010,35	€ 809,49	€ 918,39

Accuveegmachine 40Vmax VS001G

XGT
40V^{Li-Ion}
max

BL
MOTOR

XPT
EXTREME PROTECTION TECHNOLOGY



Scan de code om
de prijs te zien



Met de VS001G introduceert Makita een zeer veelzijdige accuveegmachine voor zowel binnen- als buitengebruik. De machine kan zowel fijn stof als ook grover vuil opvangen. Met een werkbreedte van 480 mm (650 mm met zijborstel) is deze efficiënt in te zetten in grotere ruimten en ook op verharde zones in open lucht, maar tegelijkertijd is de machine ook zeer wendbaar en compact.



De krachtpatser die alles opruimt

- De 40Vmax technologie garandeert een hoog vermogen, compacte afmetingen en snelle laadtijden.
- De machine maakt gebruik van een BL motor voor de aandrijving van de hoofdborstels en de zijborstel, een BL motor voor het afzuigsysteem en een derde motor voor het elektrisch schoonmaken van de stofilter door vibratie.
- Twee borstels die tegen elkaar indraaien nemen zowel het fijnstof op als grover afval op zoals zelfs 500-ml PET flesjes.
- De zijborstel aan de rechtse kant laat toe tot tegen een wand aan te reinigen.
- Het afzuigsysteem met HEPA filter houdt fijnstof tegen.
- De hoogte van zowel de hoofdborstel als zijborstel kan zeer gemakkelijk met een draaiknop ingesteld worden, perfect aangepast aan elke toepassing.

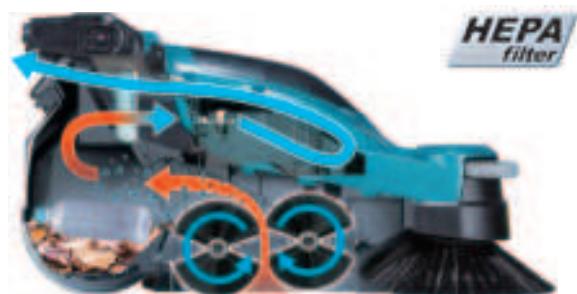

Perfekte controle

- Twee snelheden voor de hoofdborstels onderaan en zijborstel. De lage snelheid maakt de machine extra stil vergroot de autonomie.
- Afzonderlijk inschakelbare zijborstel.
- Afzonderlijk inschakelbare stofafzuiging.
- Activatie van de elektrische filterreiniging.
- Inschakelbare LED verlichting vooraan.

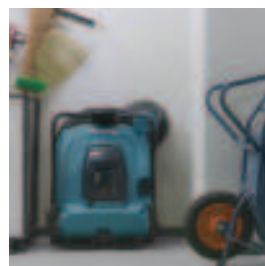

Werkt met één 40Vmax accu, het plaatsen van een tweede vergroot de autonomie. De overschakeling gebeurt automatisch.



Optioneel: multi-adapter set (1913F5-2) voor het bevestigen van een MACPAC of PDC. De voeding via een PDC vergroot de autonomie.



Optioneel: opvangzak (1913F7-8) met capaciteit van 47 l, ideaal voor grover vuil dat veel plaats inneemt zoals bladeren.

Gemakkelijk te transporteren en op te bergen

- Door het lage gewicht, de opvouwbare duwbeugel en de grote handgreep vooraan is de machine gemakkelijk te transporteren.
- Met een werkbreedte van 480 mm (650 mm met zijborstel) is de machine ook effectief in grotere ruimten maar kan bijvoorbeeld toch ook nog door een deur van 800 mm.
- De machine kan plaatsbesparend verticaal gestockeerd worden.

NIEUW

VS001GZ

Spanning	36 V (40Vmax)
Werkbreedte	480 mm
Werkbreedte met zijborstel	650 mm
Capaciteit (stapsnelheid 4 km/u)	2600 m ² /u
Inhoud standaard opvangbox	24 l
Inhoud opvangzak (optioneel)	47 l
Werktijd in vermogenstand 1-2 (accu 2x BL4080F)	480/200 min
Afmetingen (opgevouwen duwbeugel)	830 x 677 x 467 mm
Gewicht	29.9 - 33.1 kg

BOORHAMERS SDS-PLUS 2 FUNCTIES



		HR2600	HR1841FJ	HR2800
Nominaal vermogen		800 W	470 W	800 W
Slagenergie		2,4 J	1,4 J	2,8 J
Max. Ø beton		26 mm	18 mm	28 mm
AVT		-	✓	-
Vibratieniveau hamerboren		15,5 m/s ²	7,5 m/s ²	20 m/s ²
Gewicht		2,8 kg	2,5 kg	3,4 kg
Prijs in €	excl. btw	€ 189,00	€ 165,00	€ 309,00
	incl. btw	€ 228,69	€ 199,65	€ 373,89

COMBIHAMERS SDS-PLUS 3 FUNCTIES



Inclusief automatische boorkop bij HR2630X7

Inclusief Boor- en beitelset 17 stuks bij HR2630TX12 & HR2631FT12 t.w.v. € 48,50



HR2631FT12



HR2470

		HR2470	HR2630X7	HR2630TX12	HR2631FT12	HR2811FT
Nominaal vermogen		780 W	800 W	800 W	800 W	800 W
Slagenergie		2,4 J	2,4 J	2,4 J	2,4 J	2,9 J
Max. Ø beton		24 mm	26 mm	26 mm	26 mm	28 mm
AVT		-	-	-	✓	-
Vibratieniveau hamerboren		15,5 m/s ²	15 m/s ²	15 m/s ²	11,5 m/s ²	15 m/s ²
Verwisselbare boorkop		-	-	-	✓	✓
Gewicht		3,0 kg	3,0 kg	2,9 kg	3,0 kg	3,6 kg
Prijs in €	excl. btw	€ 185,00	€ 185,00	€ 255,00	€ 285,00	€ 375,00
	incl. btw	€ 223,85	€ 223,85	€ 308,55	€ 344,85	€ 453,75

COMBIHAMERS SDS-PLUS MET STOFAFZUIGING



Inclusief boor- en beitelset 17 stuks bij HR2651TX12 t.w.v. € 48,50



Inclusief stofafzuigingsunit DX11 bij HR3012FCWJ



HR2651TX12

HR3012FCWJ

		HR2651TX12	HR3012FCWJ
Nominaal vermogen		800 W	1050 W
Slagenergie		2,2 J	3,9 J
Max. Ø beton		26 mm	30 mm
AVT		✓	✓
Vibratieniveau hamerboren		11,5 m/s ²	9,5 m/s ²
Gewicht		4,2 kg	4,4 kg
Prijs in €	excl. btw	€ 315,00	€ 475,00
	incl. btw	€ 381,15	€ 574,75

COMBIHAMERS SDS-PLUS



HR3210FCT

HR3210FCT:
met anti-vibratie
handgreep

INCLUSIEF
1 automatische
boorkop (194568-7)
bij HR3210FCT



	HR3200C	HR3210FCT
Nominaal vermogen	850 W	850 W
Slagenergie	5,1 J	4,9 J
Max. Ø beton	32 mm	32 mm
AVT	-	✓
Vibratieniveau hamerboren	18 m/s ²	10 m/s ²
Gewicht	4,8 kg	5,4 kg
Prijs in €	excl. btw	€ 509,00
	incl. btw	€ 615,89

COMBIHAMERS SDS-MAX



gratis 5-delige
boor- en beitelset
P-52445 bij HR4013C, HR4511C
en HR5212C
t.w.v. € 149,00

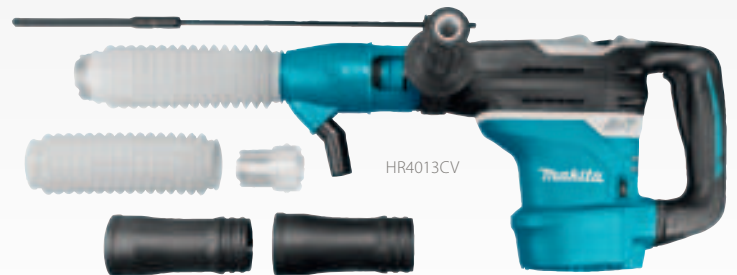

HR4013CV

CV-modellen
inclusief
stofafzuigset

	HR3541FCX	HR4013C	HR4013CV	HR4511C	HR4511CV	HR5212C
Nominaal vermogen	850 W	1100 W	1100 W	1350 W	1350 W	1500 W
Slagenergie	5,7 J	8,0 J	8,0 J	9,4 J	9,4 J	18,9 J
Max Ø beton	35 mm	40 mm	40 mm	45 mm	45 mm	52 mm
AVT	✓	✓	✓	✓	✓	✓
Vibratieniveau hamerboren	11 m/s ²	5,0 m/s ²	5,0 m/s ²	7,5 m/s ²	7,5 m/s ²	12,5 m/s ²
Gewicht	5,6 kg	6,8 kg	6,8 kg	8,8 kg	8,8 kg	12,1 kg
Prijs in €	excl. btw	€ 649,00	€ 759,00	€ 785,00	€ 885,00	€ 929,00
	incl. btw	€ 785,29	€ 918,39	€ 949,85	€ 1.070,85	€ 1.124,09

STOFZUIGSET VOOR BOOR-EN BREEKHAMERS

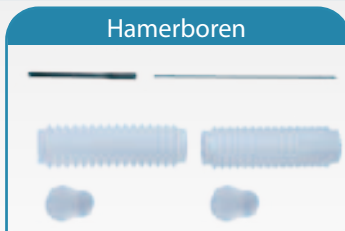

	199142-6	195866-2	196858-4
	HR4013C	HR4511C	HR5212C
Prijs in €	excl. btw	€ 96,90	€ 105,70
	incl. btw	€ 117,25	€ 127,90

BIKHAMERS SDS-PLUS



HK1820

	HK0500	HK1820	
Nominaal vermogen	550 W	550 W	
Slagfrequentie	2000-3500 /min	0-3200 /min	
Slagenergie	1,8 J	3,1 J	
AVT	-	-	
Triaxiale vibratiewaarde (ah)	9,5 m/s ²	10 m/s ²	
Gewicht	3,2 kg	3,4 kg	
Prijs in €	excl. btw	€ 335,00	€ 529,00
	incl. btw	€ 405,35	€ 640,09

BREEKHAMERS SDS-MAX



HM1213C

PROMO
gratis 5-delige
beitelset
E-20236 bij
HM0871C

Wist u dat u tijdens de garantieperiode recht hebt op één gratis onderhoudsbeurt? Ontdek er meer over op www.makita.be



SOFT NO LOAD



HM0871C



HM1214C

CV-modellen
inclusief
stofafzuigset

	HM0870C	HM0871C	HM1101C	HM1101CV	
Nominaal vermogen	1100 W	1100 W	1300 W	1300 W	
Slagfrequentie	1100-2650 /min	1100-2650 /min	1100-2600 /min	1100-2600 /min	
Slagenergie	7,6 J	8,1 J	11,5 J	11,5 J	
AVT	-	✓	-	-	
Triax. vibratie beitelen (ah)	11,5 m/s ²	8 m/s ²	13,5 m/s ²	13,5 m/s ²	
Gewicht	5,1 kg	5,8 kg	7 kg	7 kg	
Prijs in €	excl. btw	€ 379,00	€ 445,00	€ 549,00	€ 569,00
	incl. btw	€ 458,59	€ 538,45	€ 664,29	€ 688,49

	HM1111C	HM1203C	HM1213C	HM1214C	
Nominaal vermogen	1300 W	1510 W	1510 W	1510 W	
Slagfrequentie	1100-2600 /min	950-1900 /min	950-1900 /min	950-1900 /min	
Slagenergie	11,2 J	19,1 J	18,6 J	19,9 J	
AVT	✓	-	✓	✓	
Triax. vibratie beitelen (ah)	8 m/s ²	15,5 m/s ²	7 m/s ²	8 m/s ²	
Gewicht	7,7 kg	9,7 kg	10,8 kg	12,3 kg	
Prijs in €	excl. btw	€ 599,00	€ 619,00	€ 679,00	€ 799,00
	incl. btw	€ 724,79	€ 748,99	€ 821,59	€ 966,79

STOFAFZUIGING BREEKHAMERS



199144-2



197168-2

		199144-2	197168-2
Geschikt voor		Breekhamers SDS-Max	HM1812 / HM1317C
	Prijs in €	excl. btw € 53,40	€ 52,30
	incl. btw	€ 64,61	€ 63,28

SOFT NO LOAD

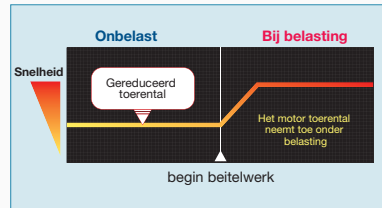

Reduceert automatisch het toerental van de machine om ongewenste trillingen verder te reduceren.

BREEKHAMERS MET ZESKANTOPNAME



SOFT NO LOAD AVT
ANTI VIBRATION TECHNOLOGY

HM1511/HM1512:
slagenergie 48,9 J



HM1812

GRATIS
trolley D-54972
bij HM1812



HM1812:
slagenergie 72,8 J



HM1511

HM1511 / HM1512 :
Uitzonderlijk laag trillingsniveau door anti-vibratie behuizing, actieve trillingsdemping en de soft-no-load regeling



		HM1317C	HM1511	HM1512	HM1812
Nominaal vermogen		1510 W	1850 W	1850 W	2000 W
Slagfrequentie		730-1450 /min	1300 /min	1300 /min	870 /min
Slagenergie		25 J	48,9 J	48,9 J	72,8 J
AVT		✓	✓	✓	✓
Triax. vibratie beitelen (ah)		8,5 m/s ²	6,5 m/s ²	6,5 m/s ²	6,5 m/s ²
Opname hex.		30 mm	30 mm	28,6 mm	28,6 mm
Gewicht		17 kg	19,2 kg	20,4 kg	31,3 kg
Prijs in €	excl. btw	€ 1.019,00	€ 1.189,00	€ 1.239,00	€ 1.769,00
	incl. btw	€ 1.232,99	€ 1.438,69	€ 1.499,19	€ 2.140,49

KLOPBOORMACHINES



HP2071FJ

	HP1631KSP	HP2051FHJ	HP2071FJ
Nominaal vermogen	710 W	720 W	1010 W
Toerental	0-3200 t.p.m.	0-2900 t.p.m.	0-2900 t.p.m.
Ø Max. staal	13 mm	13 mm	18 mm
Ø Max. hout	30 mm	40 mm	40 mm
Ø Max. steen	16 mm	20 mm	20 mm
Boorkop	1,5-13 mm	1,5-13 mm	1,5-13 mm
Makpac	-	✓	✓
Gewicht	2 kg	2,5 kg	2,6 kg
Prijs in €	excl. btw	€ 125,00	€ 179,00
	incl. btw	€ 151,25	€ 216,59

BOORMACHINES



DP4011

DP4011
Met 2 snelheden

	DP2011	DP4003	DP4011
Nominaal vermogen	370 W	750 W	720 W
Toerental	0-4200 t.p.m.	0-700 t.p.m.	0-2900 t.p.m.
Ø Max. staal	6,5 mm	13 mm	13 mm
Ø Max. hout	15 mm	38 mm	40 mm
Boorkop	0,8-6,5 mm	1,5-13 mm	1,5-13 mm
Gewicht	1,1 kg	2,4 kg	2,3 kg
Prijs in €	excl. btw	€ 125,00	€ 285,00
	incl. btw	€ 151,25	€ 344,85

DIAMANTKERNBOORMACHINES



DBM131W

DBM131W / DBM230W
Geleverd met boorstandaard



	DBM131	DBM131W	DBM230W
Nominaal vermogen	1700 W	1700 W	2500 W
Toerental onbelast 1	1100 t.p.m.	1100 t.p.m.	390 t.p.m.
Toerental onbelast 2	2300 t.p.m.	2300 t.p.m.	1040 t.p.m.
Toerental onbelast 3	-	-	1700 t.p.m.
Opname	M18	M18	1-1/4"UNC
Ø Max. beton	132 mm	132 mm	230 mm
Gewicht	6,1 kg	6,1 kg	6,9 kg
Prijs in €	excl. btw	€ 725,00	€ 1.199,00
	incl. btw	€ 877,25	€ 1.450,79

ACCESSOIRES



Diamantboren

Nieuwe beton diamantkernboren voor nat gebruik.

- Langere levensduur dankzij lasergelaste segmenten.
- Totale lengte verhoogd naar 450mm.
- Snellere boorprestatie dankzij chevron-vormige diamantdeeltjes.

Omschrijving	Best. nr.	Ø	Lengte	Opname	Stuks	Prijs excl. btw	Prijs incl. btw
Diamantkernboor	E-19869	32 mm	450 mm	1-1/4"UNC	1	€ 123,90	€ 149,92
Diamantkernboor	E-19875	42 mm	450 mm	1-1/4"UNC	1	€ 138,20	€ 167,22
Diamantkernboor	E-19881	52 mm	450 mm	1-1/4"UNC	1	€ 157,10	€ 190,09
Diamantkernboor	E-19897	62 mm	450 mm	1-1/4"UNC	1	€ 179,00	€ 216,59
Diamantkernboor	E-19906	68 mm	450 mm	1-1/4"UNC	1	€ 203,50	€ 246,24
Diamantkernboor	E-19912	72 mm	450 mm	1-1/4"UNC	1	€ 210,60	€ 254,83
Diamantkernboor	E-19928	82 mm	450 mm	1-1/4"UNC	1	€ 231,00	€ 279,51
Diamantkernboor	E-19934	92 mm	450 mm	1-1/4"UNC	1	€ 267,80	€ 324,04
Diamantkernboor	E-19940	102 mm	450 mm	1-1/4"UNC	1	€ 274,40	€ 332,02
Diamantkernboor	E-19956	107 mm	450 mm	1-1/4"UNC	1	€ 295,30	€ 357,31
Diamantkernboor	E-19962	112 mm	450 mm	1-1/4"UNC	1	€ 306,00	€ 370,26

Omschrijving	Best. nr.	Ø	Lengte	Opname	Stuks	Prijs excl. btw	Prijs incl. btw
Diamantkernboor	E-19978	117 mm	450 mm	1-1/4"UNC	1	€ 311,10	€ 376,43
Diamantkernboor	E-19984	122 mm	450 mm	1-1/4"UNC	1	€ 327,40	€ 396,15
Diamantkernboor	E-19990	127 mm	450 mm	1-1/4"UNC	1	€ 378,40	€ 457,86
Diamantkernboor	E-20002	132 mm	450 mm	1-1/4"UNC	1	€ 387,60	€ 469,00
Diamantkernboor	E-20018	142 mm	450 mm	1-1/4"UNC	1	€ 402,90	€ 487,51
Diamantkernboor	E-20024	152 mm	450 mm	1-1/4"UNC	1	€ 431,50	€ 522,12
Diamantkernboor	E-20030	162 mm	450 mm	1-1/4"UNC	1	€ 447,30	€ 541,23
Diamantkernboor	E-20046	172 mm	450 mm	1-1/4"UNC	1	€ 520,70	€ 630,05
Diamantkernboor	E-20052	182 mm	450 mm	1-1/4"UNC	1	€ 542,60	€ 656,55
Diamantkernboor	E-20068	202 mm	450 mm	1-1/4"UNC	1	€ 612,00	€ 740,52
Diamantkernboor	E-20074	212 mm	450 mm	1-1/4"UNC	1	€ 759,90	€ 919,48



P-42151

ADAPTER M18 NAAR 1-1/4" UNC
EXCL; BTW: € 42,00

HAakse BOORMACHINES



		DA3010FJ	DA3011FJ
Nominaal vermogen		450 W	450 W
Toerental		0-2400 t.p.m.	0-2400 t.p.m.
Ø Max. staal		10 mm	10 mm
Ø Max. hout		25 mm	25 mm
Boorkop		1-10 mm	1-10 mm
Gewicht		1,6 kg	1,6 kg
Prijs in €	excl. btw	€ 295,00	€ 295,00
	incl. btw	€ 356,95	€ 356,95

KERNBOORMACHINE MET MAGNEETVOET



		HB350	HB500
Nominaal vermogen		1050 W	1150 W
Toerental onbelast 1		450 t.p.m.	350 t.p.m.
Toerental onbelast 2		850 t.p.m.	650 t.p.m.
Ø Max. staal		35 mm	50 mm
Klemkracht magneetvoet		8000 N	9300 N
Opname		3/4" WELDON	3/4" WELDON
Gewicht		11,5 kg	18,5 kg
Prijs in €	excl. btw	€ 729,00	€ 1.349,00
	incl. btw	€ 882,09	€ 1.632,29

MENGRS



UT1600

		UT1400	UT1401	UT1600
Nominaal vermogen		1300 W	1300 W	1800 W
Toerental onbelast 1		0-900 t.p.m.	0-400 t.p.m.	0-440 t.p.m.
Toerental onbelast 2		-	0-730 t.p.m.	0-970 t.p.m.
Toerental belast max.		0-580 t.p.m.	0-450 t.p.m.	0-580 t.p.m.
Schroefdraad spindel		M14	M14	M14
Gewicht		5,2 kg	5,5 kg	7,1 kg
Prijs in €	excl. btw	€ 309,00	€ 355,00	€ 435,00
	incl. btw	€ 373,89	€ 429,55	€ 526,35

BOORMACHINE / MENGER



		DS4012
Nominaal vermogen		750 W
Toerental		600 t.p.m.
Ø Max. staal		13 mm
Ø Max. hout		36 mm
Boorkop		2-13 mm
Gewicht		2,8 kg
Prijs in €	excl. btw	€ 245,00
	incl. btw	€ 296,45

SCHROEFAUTOMATEN

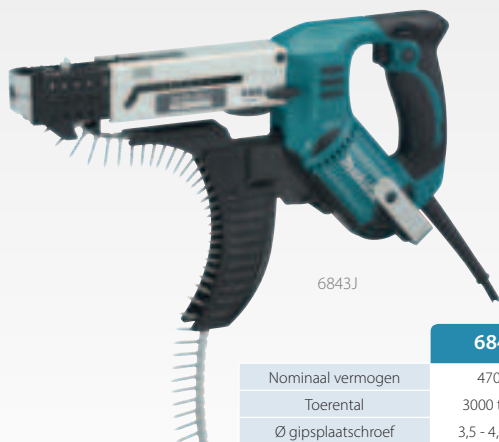

6843J

		6844	6843J
Nominaal vermogen		470 W	470 W
Toerental		3000 t.p.m.	6000 t.p.m.
Ø gipsplaat Schroef		3,5 - 4,0 mm	3,5 - 4,0 mm
Schroeflengte		45-75 mm	25-55 mm
Verpakking		Koffer	Makpac
Gewicht		2 kg	2 kg
Prijs in €	excl. btw	€ 399,00	€ 405,00
	incl. btw	€ 482,79	€ 490,05

SCHROEFMACHINES VOOR GIPSPLAAT



FS2500K: met 1/4" Hex bitopname



FS2500



FS2701K

FS2701K: met koppelinstelling (6 stappen)



schroeflintadapter 191L24-0

		FS2300K	FS2500K	FS2701K	FS4000JX2	FS6300RJX2
Nominaal vermogen		570 W	570 W	570 W	570 W	570 W
Toerental		0-2500 t.p.m	0-2500 t.p.m	0-2500 t.p.m	0-4000 t.p.m.	0-6000 t.p.m.
Ø gipsplaat Schroef		5 mm	5 mm	5 mm	5 mm	5 mm
Incl. schroeflintadapter		-	-	-	✓	✓
Gewicht		1,7 kg	1,6 kg	1,7 kg	1,3 kg	1,4 kg
Prijs in €	excl. btw	€ 175,00	€ 215,00	€ 249,00	€ 199,00	€ 209,00
	incl. btw	€ 211,75	€ 260,15	€ 301,29	€ 240,79	€ 252,89

COMFORTABEL WERKEN MET SUPER JOINT SYSTEM II

Zonder SJS

Kogellager
Kegeltandwiel in tandwielhuis
Spindel

Kogellager
Meeneem-nok (op spindel geperst)
Bladveer
Kegeltandwiel in tandwielhuis
Spindel

Bladveer

Bladveer absorbeert trillingen en vermindert schokken tijdens het werken

HAAKSE SLIJPER 125 MM

GA5034

GA5030RSP2

	GA5034	GA5030RK	GA5030RSP2
Nominaal vermogen	720 W	720 W	720 W
Toerental	11000 t.p.m.	11000 t.p.m.	11000 t.p.m.
Ø schijf	125 mm	125 mm	125 mm
Dodemansschakelaar	✓	-	-
Gewicht	1,9 kg	1,8 kg	1,8 kg
Prijs in €	excl. btw	€ 99,00	€ 119,00
	incl. btw	€ 119,79	€ 143,99

HAAKSE SLIJPER 115 MM

GA4530RK

GA4530RK	
Nominaal vermogen	720 W
Toerental	11000 t.p.m.
Ø schijf	115 mm
Gewicht	1,8 kg
Prijs in €	excl. btw
	incl. btw

HAAKSE SLIJPER 125 MM

9558HNRGK3

125 MM

9558HNRGK3: geleverd met 1 afbraamschijf en 2 diamantschijven

9558PBGY met dodemansschakelaar: motor schakelt uit bij loslaten van schakelaar voor verhoogde veiligheid

	9558HNRGZ	9558PBGY	9558HNRGK3
Nominaal vermogen	840 W	840 W	840 W
Toerental	11000 t.p.m.	11000 t.p.m.	11000 t.p.m.
Ø schijf	125 mm	125 mm	125 mm
Dodemansschakelaar	-	✓	-
Gewicht	2,1 kg	2,1 kg	2,1 kg
Prijs in €	excl. btw	€ 99,00	€ 129,00
	incl. btw	€ 119,79	€ 156,09

HAAKSE SLIJPER 125 MM X-LOCK



X-LOCK
Snel en veilig schijven bevestigen via een kliksysteem.



GA5080RX03

GA5080RX03

Nominaal vermogen	1400 W	
Toerental	12000 t.p.m.	
Ø schijf	125 mm	
Verpakking	Makpac	
Gewicht	2,5 – 3,6 kg	
Prijs in €	excl. btw	€ 199,00
	incl. btw	€ 240,79

HAAKSE SLIJPERS 125 MM



GA5041CT01

GA5040CJD1



GA5041CT01
met mechanische motorrem,
instelbaar toerental, Ezynut & AVT-grip

SA5040C Traagdraaiend

	GA5040RZ	GA5040RKDJ	GA5040C	GA5040CJD	GA5040CJD1	GA5041RZ	GA5041CT01	SA5040C	
Nominaal vermogen	1100 W	1100 W	1400 W	1400 W	1400 W	1100 W	1400 W	1400 W	
Toerental	11000 t.p.m.	11000 t.p.m.	2800-11000 t.p.m.	2800-11000 t.p.m.	2800-11000 t.p.m.	11000 t.p.m.	2700-11000 t.p.m.	2000-7800 t.p.m.	
Heropstartbeveiliging	✓	✓	✓	✓	✓	✓	✓	✓	
Mechanische rem	-	-	-	-	-	✓	✓	-	
Type schakelaar	Schuifschakelaar met vergrendeling	Schuifschakelaar met vergrendeling	Schuifschakelaar met vergrendeling	Schuifschakelaar met vergrendeling	Schuifschakelaar met vergrendeling	Schuifschakelaar met vergrendeling	Schuifschakelaar met vergrendeling	Schuifschakelaar met vergrendeling	
Verpakking	Karton	Makpac	Karton	Makpac	Makpac	Karton	Karton	Karton	
Gewicht	2,4 kg	2,4 kg	2,4 kg	2,4 kg	2,7 kg	2,4 kg	2,7 kg	2,2 kg	
Meegeleverde accessoires	-	2 x diamantschijf	-	2 x diamantschijf	1 x diamantschijf + beschermkap stofafzuiging	-	AVT-greep + Ezynut sluitmoer	-	
Prijs in €	excl. btw	€ 139,00	€ 175,00	€ 179,00	€ 215,00	€ 245,00	€ 199,00	€ 225,00	€ 249,00
	incl. btw	€ 168,19	€ 211,75	€ 216,59	€ 260,15	€ 296,45	€ 240,79	€ 272,25	€ 301,29

HAAKSE SLIJPERS 125 MM / 150 MM



9565PCV01

9565PCV01 & 9566PCV01: Antivibratiehandgreep en dodemansschakelaar.



GA5050R: grote lepelschakelaar + gereedschapsloze beschermkap

	GA5050R	9565CRX1	9565PCV01	9566PCV01	GA6040C	
Nominaal vermogen	1300 W	1400 W	1400 W	1400 W	1400 W	
Toerental	11000 t.p.m.	11000 t.p.m.	2800-11500 t.p.m.	4000-10000 t.p.m.	4000-9000 t.p.m.	
SJS	-	✓	✓	✓	✓	
Ø schijf	125 mm	125 mm	125 mm	150 mm	150 mm	
Type schakelaar	Lepelschakelaar zonder vergrendeling	Schuifschakelaar met vergrendeling	Lepelschakelaar zonder vergrendeling	Lepelschakelaar zonder vergrendeling	Schuifschakelaar met vergrendeling	
Gewicht	2,5 kg	2,6 kg	2,6 kg	2,7 kg	2,6 kg	
Prijs in €	excl. btw	€ 149,00	€ 149,00	€ 159,00	€ 205,00	€ 199,00
	incl. btw	€ 180,29	€ 180,29	€ 192,39	€ 248,05	€ 240,79

HAAKSE SLIJPERS 125 MM



GA5021CY

GA5021CYX1:
Inclusief antivibratiegreep en Ezynut sluitmoer

	GA5021C	GA5021CY	GA5021CYX1	
Nominaal vermogen	1450 W	1450 W	1450 W	
Toerental	10000 t.p.m.	10000 t.p.m.	10000 t.p.m.	
Ø schijf	125 mm	125 mm	125 mm	
Dodemansschakelaar	-	✓	✓	
Gewicht	3 kg	3 kg	3 kg	
Prijs in €	excl. btw	€ 209,00	€ 209,00	€ 235,00
	incl. btw	€ 252,89	€ 252,89	€ 284,35

10x
Doorslijpschijven
in blik



Ref.	Ø (mm)	Dikte (mm)	Ø asgat (mm)	Prijs	
				excl. btw	incl. btw
D-18770-10	125	1,2	22,23	€ 13,90	€ 16,82

HAAKSE SLIJERS 125 MM

- Bestand tegen langdurige hoge belasting dankzij verbeterde koeling
- Greepomtrek van slechts 205 mm
- Mechanische rem (GA5091, GA5093, GA5094)
- De AFT functie stopt de motor ogenblikkelijk wanneer de schijf blokkeert



PROMO

gratis snelsluitmoer EZYNUT 195354-9

	GA5092X01	GA5090X01	GA5091X01	GA5095X01	GA5094	GA5093X01
Nominaal vermogen	1900 W	1900 W	1900 W	1900 W	1900 W	1900 W
Toerental	11500 min ⁻¹	2800-11500 min ⁻¹	2800-11500 min ⁻¹	11500 min ⁻¹	11500 min ⁻¹	2800-11500 min ⁻¹
Variabel toerental	-	✓	✓	-	-	✓
Mechanische rem	-	-	✓	-	✓	✓
Type Schakelaar	Schuifschakelaar	Schuifschakelaar	Schuifschakelaar	Lepelschakelaar	Lepelschakelaar	Lepelschakelaar
Dodemansschakelaar	-	-	-	✓	✓	✓
Gewicht	2,6 - 3,8 kg	2,6 - 3,8 kg	2,8 - 4,0 kg	2,7 - 3,8 kg	2,9 - 4,0 kg	2,9 - 4,0 kg
Prijs in €	excl. btw	€ 189,00	€ 209,00	€ 229,00	€ 199,00	€ 239,00
	incl. btw	€ 228,69	€ 252,89	€ 277,09	€ 240,79	€ 289,19

ACCESSOIRES

	Omschrijving	Artikel	Diameter	Dikte	Asgat	Reductiering	Specificatie	Hoogte segment	Verpakkings-eenheid	Prijs excl. btw	Prijs incl. btw
	Doorslijpschijf staal	P-53023	125 mm	1,0 mm	22,23 mm		A60R-BF		1	€ 2,20	€ 2,66
	Doorslijpschijf inox	P-53045	125 mm	1,0 mm	22,23 mm		A60S-BF		1	€ 2,20	€ 2,66
	Doorslijpschijf inox 'Fast cutting'	B-45733	125 mm	0,8 mm	22,23 mm		Z60T-BF		1	€ 2,40	€ 2,90
	Doorslijpschijf inox 'Fast cutting'	B-45733-12	125 mm	0,8 mm	22,23 mm		Z60T-BF		12	€ 28,00	€ 33,88
	Diamantschijf Comet	B-12778	125 mm	2,0 mm	22,23 mm	20 mm		10 mm	1	€ 53,40	€ 64,61
	Doorslijpschijf staal	P-05773	230 mm	2,5 mm	22,23 mm		A30S4-BF		1	€ 3,10	€ 3,75
	Doorslijpschijf inox	E-13764	230 mm	1,9 mm	22,23 mm		A60U-BF		1	€ 5,50	€ 6,66
	Diamantschijf Comet	B-12784	230 mm	2,6 mm	22,23 mm			10 mm	1	€ 121,60	€ 147,14

HAAKSE SLIJERS 180 MM



	GA7050	GA7060	GA7082	GA7070X1	GA7070YX1	
Nominaal vermogen	2000 W	2200 W	2800 W	2800 W	2800 W	
Toerental	8500 t.p.m.	8500 t.p.m.	8500 t.p.m.	8500 t.p.m.	8500 t.p.m.	
Dodemansschakelaar	✓	✓	-	-	✓	
Draaibare achterhandgreep	-	-	-	✓	✓	
Mechanische rem	-	-	-	✓	✓	
Gewicht	4,5 kg	5,3 kg	6,0 kg	6,2 - 6,7 kg	6,1 - 6,6 kg	
Prijs in €	excl. btw	€ 129,00	€ 149,00	€ 155,00	€ 299,00	€ 319,00
	incl. btw	€ 156,09	€ 180,29	€ 187,55	€ 361,79	€ 385,99

HAAKSE SLIJPERS 230 MM



GA9061R



GA9082



GA9060KD

Incl. diamantschijf

		GA9050	GA9060	GA9060KD	GA9082	GA9061R
Nominaal vermogen		2000 W	2200 W	2200 W	2700 W	2200 W
Toerental		6600 t.p.m.	6600 t.p.m.	6600 t.p.m.	6600 t.p.m.	6600 t.p.m.
Soft start		-	-	-	✓	✓
Dodemansschakelaar		✓	✓	✓	-	-
Draaibare achterhandgreep		-	-	-	-	-
Heropstartbeveiliging		-	-	-	-	✓
Gewicht		4,7 kg	5,6 kg	5,6 kg	6,1 kg	5,7 kg
Prijs in €	excl. btw	€ 135,00	€ 159,00	€ 179,00	€ 165,00	€ 209,00
	incl. btw	€ 163,35	€ 192,39	€ 216,59	€ 199,65	€ 252,89



HAAKSE SLIJPERS 230 MM



GA9040RF01



GA9030SF01



GA9070YX1



GA9071YX1:
Met gesloten handgreep

		GA9030SF01	GA9030RF01	GA9040SF01	GA9040RF01	GA9080X1	GA9070X1	GA9070YX1	GA9071X1	GA9071YX1
Nominaal vermogen		2400 W	2400 W	2600 W	2600 W	2700 W	2800 W	2800 W	2800 W	2800 W
Toerental		6600 t.p.m.	6600 t.p.m.	6600 t.p.m.	6600 t.p.m.	6600 t.p.m.	6600 t.p.m.	6600 t.p.m.	6600 t.p.m.	6600 t.p.m.
Dodemansschakelaar		✓	-	✓	-	-	-	✓	-	✓
Draaibare achterhandgreep		✓	✓	✓	✓	✓	✓	✓	✓	✓
Antivibratie zijhandgreep		✓	✓	✓	✓	-	✓	✓	✓	✓
Soft start		✓	✓	✓	✓	✓	✓	✓	✓	✓
Heropstartbeveiliging		-	✓	-	✓	✓	✓	✓	✓	✓
Mechanische rem		-	-	-	-	-	✓	✓	✓	✓
Gewicht		6,3 kg	6,5 kg	6,7 kg	6,9 kg	6,4 kg	6,3 kg	6,3 - 8,5 kg	6,4 kg	6,3 - 8,5 kg
Prijs in €	excl. btw	€ 209,00	€ 209,00	€ 219,00	€ 219,00	€ 259,00	€ 315,00	€ 335,00	€ 315,00	€ 335,00
	incl. btw	€ 252,89	€ 252,89	€ 264,99	€ 264,99	€ 313,39	€ 381,15	€ 405,35	€ 381,15	€ 405,35

STEMPELSLIJERS



	GD0600	GD0603	GD0800C	GD0810C	GD0801C	GD0811C	GS5000
Nominaal vermogen	400 W	240 W	750 W	750 W	750 W	750 W	750 W
Toerental	25000 t.p.m.	28000 t.p.m.	7000-28000 t.p.m.	1800-7000 t.p.m.	7000-28000 t.p.m.	1800-7000 t.p.m.	5600 t.p.m.
Ø spantang - bereik	6 mm	6 mm	6-8 mm	6-8 mm	6-8 mm	6-8 mm	20 mm
Ø spantang - inbegrepen	6 mm	6 mm	6 mm	6 mm	6 mm	6 mm	20 mm
Lepelschakelaar	✓	-	-	-	✓	✓	-
Dodemans	-	-	-	-	✓	✓	✓
Gewicht	1,7 kg	0,97 kg	1,7 kg	1,7 kg	1,7 kg	2,0 kg	5,0 kg
Prijs in €	excl. btw	€ 179,00	€ 179,00	€ 315,00	€ 335,00	€ 315,00	€ 465,00
	incl. btw	€ 216,59	€ 216,59	€ 381,15	€ 405,35	€ 381,15	€ 562,65



COMBOPACK SLIJERS



	DK0047GX1	DK0046X1	
Haakse slijper 230 mm	GA9060	GA9061R	
Haakse slijper 125 mm	9558HNRG	GA5040RZ	
Diamantschijf	2 x Diamak DS	2 x Diamak DS	
Synthetische koffer	✓	✓	
Prijs in €	excl. btw	€ 285,00	€ 325,00
	incl. btw	€ 344,85	€ 393,25

COMBOPACK KLOPBOORMACHINE + HAAKSE SLIJER



	DK0050X1	
Klopboormachine 710 W	HP1631	
Haakse slijper 125 mm	GA5030R	
Borensset	D-08660	
Synthetische koffer	✓	
Prijs in €	excl. btw	€ 205,00
	incl. btw	€ 248,05

COMBOPACK SCHUURMACHINE + STOFZUIGER



	DK6525	
Schuurmachine	BO6050J	
Stofzuiger	VC2510LX1	
Prijs in €	excl. btw	€ 709,00
	incl. btw	€ 857,89

METAALAFKORTMACHINES

LC1230N

- Inclusief HM zaagblad
- verstekhoek instelbaar op 45°



LW1400X



LC1230N

LW1400X LC1230N

Nominaal vermogen	2200 W	1750 W	
Type schijf	doorslijpschijf	zaagblad	
Toerental	3800 t.p.m.	1300 t.p.m.	
Zaagdiepte (90°)	115 mm	100 mm	
Ø Zaagblad	355 mm	305 mm	
Gewicht	17,2 kg	19,3 kg	
Prijs in €	excl. btw	€ 355,00	€ 725,00
	incl. btw	€ 429,55	€ 877,25

BETONSCHAVEN

PC5001C
Geleverd met komschijf B-12289



PC5010C

PC50001C

PC5010C PC5001C

Nominaal vermogen	1400 W	1400 W	
Ø schijf	125 mm	125 mm	
Gewicht	2,5 kg	5,1 kg	
Prijs in €	excl. btw	€ 335,00	€ 719,00
	incl. btw	€ 405,35	€ 869,99

PC5010C:
Instelbaar toerental

MUURFREZEN



SG150



SG181

SG1251J SG150 SG181

Nominaal vermogen	1400 W	1800 W	2150 W	
Max. slijpdiepte	30 mm	45 mm	60 mm	
Sleufbreedte	6-30 mm	7-35 mm	7-43 mm	
Ø schijf	125 mm	150 mm	180 mm	
Gewicht	4,4 kg	5,7 kg	6 kg	
Prijs in €	excl. btw	€ 549,00	€ 829,00	€ 1.119,00
	incl. btw	€ 664,29	€ 1.003,09	€ 1.353,99

DIAMANTZAAG



4114S

Nominaal vermogen	2400 W	
Max. slijpdiepte	125 mm	
Ø schijf	350 mm	
Ø asgat	25,4 mm	
Gewicht	10,8 kg	
Prijs in €	excl. btw	€ 699,00
	incl. btw	€ 845,79

DIAMANTZAAG



4100KB

Nominaal vermogen	1400 W	
Zaagdiepte (90°)	40 mm	
Ø Zaagblad	125 mm	
Gewicht	3,0 kg	
Prijs in €	excl. btw	€ 179,00
	incl. btw	€ 216,59

SLAGMOERSLEUTELS



TW0200J
TW0350J
6906J

TW0350J

	TW0200J	TW0350J	6906J	TW1000
Nominaal vermogen	380 W	400 W	650 W	1300 W
Max. koppel	200 Nm	350 Nm	588 Nm	1000 Nm
Bitopname	1/2" vierkant	1/2" vierkant	3/4" vierkant	1" vierkant
Gewicht	2,2 kg	3 kg	5,6 kg	8,6 kg
Prijs in €	excl. btw	€ 325,00	€ 385,00	€ 619,00
	incl. btw	€ 393,25	€ 465,85	€ 748,99

HETELUCHTPISTOLEN



HG6531CK



HG5030K

	HG5030K	HG6031VK	HG6531CK
Vermogen	1600 W	1800 W	2000 W
Temperatuurbereik	350-500 °C	50-600 °C	50-650 °C
Temperatuurstelling	2 niveaus	9 niveaus	Elektronisch in stappen van 5°C
Debiet	300 / 500 l/min	250 / 500 l/min	200 / 550 l/min
Gewicht	0,56 kg	0,67 kg	0,71 kg
Prijs in €	excl. btw	€ 79,00	€ 105,00
	incl. btw	€ 95,59	€ 127,05

KNABELSCHAREN



JN3201J

	JN1601	JN3201J
Nominaal vermogen	550 W	710 W
Max. dikte staal	1,6 mm	3,2 mm
Gewicht	1,6 kg	3,4 kg
Prijs in €	excl. btw	€ 395,00
	incl. btw	€ 477,95

PLAATSCHAREN



JS1602J

	JS1601J	JS1602J	JS3201J
Nominaal vermogen	380 W	380 W	710 W
Aantal zaagbewegingen	4500 /min	4000 /min	1600 /min
Max. dikte staal	1,6 mm	1,6 mm	3,2 mm
Gewicht	1,4 kg	1,6 kg	3,4 kg
Prijs in €	excl. btw	€ 355,00	€ 365,00
	incl. btw	€ 429,55	€ 441,65

METAALCIRKELZAAG



4131

Nominaal vermogen	1100 W	
Toerental	3500 t.p.m.	
Zaagdiepte (90°)	63 mm	
Ø Zaagblad	185 mm	
Gewicht	5,1 kg	
Prijs in €	excl. btw	€ 445,00
	incl. btw	€ 538,45

GROEFFREES



CA5000XJ

Nominaal vermogen	1300 W	
Toerental	2200-6400 t.p.m.	
Ø Zaagblad	118 mm	
Gewicht	5,1 kg	
Prijs in €	excl. btw	€ 599,00
	incl. btw	€ 724,79

SLIJPMOLENS



GB801

	GB602W	GB801
Nominaal vermogen	250 W	550 W
Toerental	2850 t.p.m.	2850 t.p.m.
Ø Slijpsteen	150 mm	205 mm
Gewicht	9 kg	19,8 kg
Prijs in €	excl. btw	€ 195,00
	incl. btw	€ 235,95

LINTZAAGMACHINE

B-42581	€ 14,90
Schuurbanden 20 x 2240 mm	excl. btw
Rood • Korrel 80	€ 18,03
	incl. btw
B-42597	€ 14,90
Schuurbanden 20 x 2240 mm	excl. btw
Rood • Korrel 120	€ 18,03
	incl. btw
JM21000330	€ 13,80
Adapterset voor schuurbanden	excl. btw
	€ 16,70
	incl. btw



LB1200F

Nominaal vermogen	900 W	
Breedte zaaglint	6-16 mm	
Gewicht	81,2 kg	
Prijs in €	excl. btw	€ 815,00
	incl. btw	€ 986,15

RECIPROZAGEN



JR3070CT

		JR3051TK	JR3061T	JR3070CT
Nominaal vermogen		1200 W	1250 W	1510 W
Aantal zaagbewegingen		0-3000 /min	0-2800 /min	0-2800 /min
AVT		-	-	✓
Pendelinstelling		-	-	✓
Slaglengthe		30 mm	32 mm	32 mm
Vibratieniveau		19,5 m/s ²	23,5 m/s ²	8,5 m/s ²
Gewicht		3,2 kg	4,4 kg	4,4 kg
Prijs in €	excl. btw	€ 175,00	€ 229,00	€ 295,00
	incl. btw	€ 211,75	€ 277,09	€ 356,95

LAMELLENFREES



Aanslagplaat met tandheugelverstelling voor een snelle en precieze aanpassing aan de materiaaldikte.

Revolver diepte-instelling met 6 preselecties voor een snelle afstelling.



Kantelbare voetplaat met handige vergrendelingshendel en automatische stops op 0°, 45° en 90°.

		PJ7000J
Nominaal vermogen		700 W
Toerental		11000 t.p.m.
Ø zaagblad		100 mm
Asgat		22 mm
Gewicht		2,5 kg
Prijs in €	excl. btw	€ 319,00
	incl. btw	€ 385,99

MULTITOOL



INCLUSIEF:
Set van 9 accessoires,
30 schuurvellen en 1 afzuigset



GEREEDSCHAPSLOZE
ACCESSOIREWISSEL

		TM3010CX3J
Nominaal vermogen		320 W
Oscillatiefrequentie		6000-20000/min
Oscillatiehoek		3,2°
Gewicht		1,6 kg
Prijs in €	excl. btw	€ 255,00
	incl. btw	€ 308,55

VANDIKTEBANK



		2012NB
Nominaal vermogen		1650 W
Toerental		8500 t.p.m.
Breedte		304 mm
Max. doorlaathoogte		155 mm
Max. spaanafname		3 mm
Gewicht		28,1 kg
Prijs in €	excl. btw	€ 845,00
	incl. btw	€ 1.022,45

KETTINGFREZEN

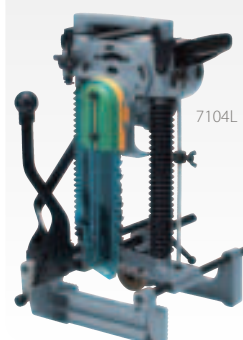

		7104L	7104L-30
Nominaal vermogen		1140 W	1140 W
Toerental		3200 t.p.m.	3200 t.p.m.
Kettingsnelheid onbelast		5 m/s	5 m/s
Ketting		16,5 mm	30 mm
Gatbreedte		16,5-30 mm	30-45 mm
Gatlengthe		54-130 mm	54-130 mm
Gewicht		17,3 kg	17,3 kg
Prijs in €	excl. btw	€ 1.509,00	€ 1.649,00
	incl. btw	€ 1.825,89	€ 1.995,29

BOVENFREZEN



RP1111CJ



RP2302FC07

RP2302FC07: Inclusief langseleider met fijnafstelling

	RP0900J	RP1111CJ	RP1802FX02	RP2302FC07
Nominaal vermogen	900 W	1100 W	1850 W	2300 W
Toerental	27000 t.p.m.	8000 - 27500 t.p.m.	23000 t.p.m.	9000-22000 t.p.m.
Max. induikdiepte	35 mm	57 mm	70 mm	70 mm
Ø Spantang - bereik	6-8 mm	6-8 mm	6-12 mm	6-12 mm
Ø Spantang - inbegrepen	8 mm	8 mm	6, 8, 12 mm	6, 8, 12 mm
Verpakking	Makpac	Makpac	Karton	Makpac
Gewicht	2,7 kg	3,3 kg	6,2 kg	6,1 kg
Prijs in €	excl. btw	€ 229,00	€ 369,00	€ 469,00
	incl. btw	€ 277,09	€ 446,49	€ 567,49

KANTENFREZEN



3711



3712

3712: Inclusief kantelbare zool

	3711	3712	
Nominaal vermogen	530 W	530 W	
Toerental	32000 t.p.m.	32000 t.p.m.	
Max. induikdiepte	42 mm	42 mm	
Spantang	6 mm	6 mm	
Gewicht	1,5 kg	1,7 kg	
Prijs in €	excl. btw	€ 105,00	€ 125,00
	incl. btw	€ 127,05	€ 151,25

BOVEN- EN KANTENFREES



4 MACHINES IN 1

- Rechte kantenrees
- Verstelbare kantenrees
- Kantenrees met verschoven spindel
- Bovenrees

Rechte kantenrees
Regelbare freesdiepte van 0 tot 40 mm

Verstelbare kantenrees
Hoekinstelling tussen -30° en 45°

Kantenrees met verschoven spindel om zo dicht mogelijk tegen een obstakel te werken

Bovenrees
Diepteregeling per 1/10 van een mm van 0 tot 35 mm

RT0702CX3J

Nominaal vermogen	710 W	
Toerental	10000-30000 t.p.m.	
Max. induikdiepte	35 mm	
Ø Spantang - bereik	6 - 8 mm	
Ø Spantang - inbegrepen	6 mm, 8 mm	
Gewicht	1,8 kg	
Prijs in €	excl. btw	€ 319,00
	incl. btw	€ 385,99

SCHAVEN



KP0810CJ

1100

	KP0800J	KP0810J	KP0810CJ	1100	1911BJ	1806B	KP312S
Nominaal vermogen	620 W	850 W	1050 W	950 W	900 W	1200 W	2200 W
Toerental	17000 t.p.m.	16000 t.p.m.	12000 t.p.m.	16000 t.p.m.	16000 t.p.m.	18000 t.p.m.	12000 t.p.m.
Breedte	82 mm	82 mm	82 mm	82 mm	110 mm	170 mm	312 mm
Max. spaanafname	2,5 mm	4 mm	4 mm	3 mm	2 mm	2 mm	3,5 mm
Gewicht	2,6 kg	3,3 kg	3,4 kg	5,1 kg	4,3 kg	9,0 kg	18,4 kg
Prijs in €	excl. btw	€ 225,00	€ 309,00	€ 339,00	€ 429,00	€ 369,00	€ 2.499,00
	incl. btw	€ 272,25	€ 373,89	€ 410,19	€ 519,09	€ 446,49	€ 3.023,79

DECOUPEERZAGEN



4350FCTJ



4351FCTJ



JV0600J



4329K



	4326	4329K	JV0600J	4350FCTJ	4351FCTJ
Nominaal vermogen	450 W	450 W	650 W	720 W	720 W
Aantal zaagbewegingen	3100 /min	500-3100 /min	500-3100 /min	800-2800 /min	800-2800 /min
Max. capaciteit hout	65 mm	65 mm	90 mm	135 mm	135 mm
Makpac	-	-	✓	✓	✓
Gewicht	1,8 kg	1,9 kg	2,4 kg	2,6 kg	2,5 kg
Prijs in €	excl. btw	€ 95,00	€ 115,00	€ 149,00	€ 219,00
	incl. btw	€ 114,95	€ 139,15	€ 180,29	€ 264,99

COMBOPACK

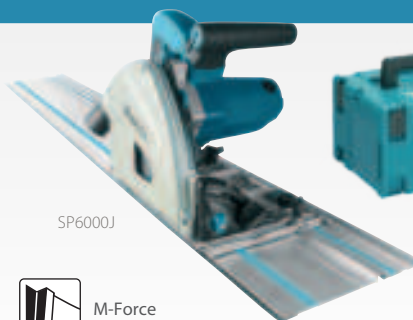

SP6000J



M-Force



4351FCTJ



MEU029J

Invalcirkelzaag	SP6000J	
Decoupeerzaag	4351FCTJ	
Geleiderail 1400 mm	194368-5	
Extra cirkelzaagblad	B-32007	
Decoupeerzaagbladen	5	
Draagtas	B-57613	
Prijs in €	excl. btw	€ 609,00
	incl. btw	€ 736,89

INVALCIRKELZAAG

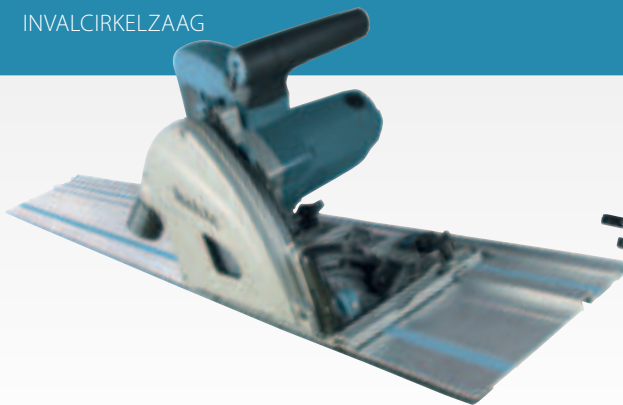

Bij model SP6000J1
2 x geleiderail 1,4 m
+ koppelstrips

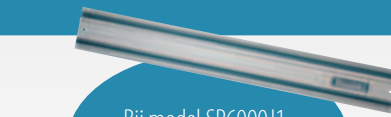

	SP6000J	SP6000J1
Nominaal vermogen	1300 W	1300 W
Zaagdiepte (90°)	57 mm	57 mm
Zaagdiepte (45°)	40 mm	40 mm
Max. zaagdiepte (48°)	38 mm	38 mm
Ø Zaagblad	165 mm	165 mm
Gewicht	4,4 kg	4,4 kg
Prijs in €	excl. btw	€ 379,00
	incl. btw	€ 458,59

CIRKELZAGEN



5008MGJX



Zaagblad gratis bij 5008MGJX t.w.v. € 22,90



HS7101JX



2 x zaagblad 12 tanden bij HS7101JX t.w.v. € 37,20
2 x zaagblad 16 tanden bij 5903RKX1 t.w.v. € 45,80



HS0600



5143R

	HS6601	HS6101J	HS7601J	HS7101JX	5008MGJX	5903RKX1	HS0600	5103R	5143R
Nominaal vermogen	1050 W	1100 W	1200 W	1400 W	1800 W	2000 W	2000 W	2100 W	2200 W
Zaagdiepte (90°)	54,5 mm	54,5 mm	66 mm	67 mm	75,5 mm	85 mm	101 mm	100 mm	130 mm
Ø Zaagblad	165 mm	165 mm	190 mm	190 mm	210 mm	235 mm	270 mm	270 mm	355 mm
Gewicht	3,7 kg	3,7 kg	4,0 kg	4,0 kg	5,1 kg	7,2 kg	6,9 kg	9,4 kg	14,0 kg
Prijs in €	excl. btw	€ 285,00	€ 285,00	€ 285,00	€ 285,00	€ 385,00	€ 355,00	€ 519,00	€ 849,00
	incl. btw	€ 187,55	€ 344,85	€ 211,75	€ 344,85	€ 344,85	€ 465,85	€ 429,55	€ 627,99

TAFEL-, AFKORT- EN VERSTEKZAGEN



LF1000

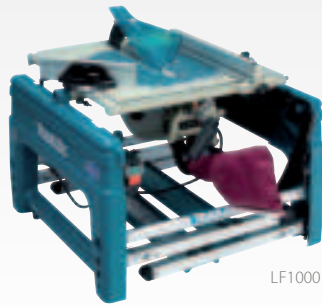

LF1000



LH1201FL

**SNELLE OMBOUW
VAN TAFEL- NAAR
AFKORTZAAGFUNCTIE**

	LH1040	LH1201	LF1000
Verstekhoek	90°	45°	90°
90°	91 x 95 mm 69 x 130 mm	95 x 155 mm 62 x 200 mm	68 x 155 mm 20 x 180 mm
45°	69 x 85 mm	62 x 125 mm	50 x 150 mm

	LH1040F	LH1201FL	LF1000
Nominaal vermogen	1650 W	1650 W	1650 W
Ø Zaagblad	260 mm	305 mm	260 mm
Gewicht	14,3 kg	20,7 kg	36 kg
Prijs in €	excl. btw	€ 649,00	€ 1.099,00
	incl. btw	€ 785,29	€ 1.329,79

AFKORT-VERSTEKZAAG



Kantelbaar naar links tot 45°

		LS1040N
Nominaal vermogen		1650 W
Ø Zaagblad		260 mm
Max. zaagdiepte 0°		91 x 95 mm
Max. zaagdiepte 45°		91 x 67 mm
Gewicht		12,4 kg
Prijs in €	excl. btw	€ 355,00
	incl. btw	€ 429,55

TAFELZAAG MET ONDERSTEL



		2704NX1
Nominaal vermogen		1650 W
Ø Zaagblad		260 mm
Gewicht		34,9 kg
Prijs in €	excl. btw	€ 1.399,00
	incl. btw	€ 1.692,79

TAFELZAAG



MLT100N

Nominaal vermogen		1500 W
Ø Zaagblad		260 mm
Gewicht		34,7 kg
Prijs in €	excl. btw	€ 729,00
	incl. btw	€ 882,09

Optioneel accessoire:
JM27000300
Onderstel MLT100N
€ 294,80 excl. btw
€ 356,71 incl. btw



BOUWCIRKELZAAG



2712

Nominaal vermogen		2000 W
Ø Zaagblad		315 mm
Gewicht		52,9 kg
Prijs in €	excl. btw	€ 499,00
	incl. btw	€ 603,79

TELESCOPISCHE AFKORT-VERSTEKZAGEN

PROMO

Gratis onderstel DEBWST06 t.w.v. € 254 bij LS1019L/LS1219L

Model	DEBWST06 - Onderstel
LS1019	✓ 
LS1219	✓ 

t.w.v. € 254,00
excl. btw

Max. lengte: 2550 mm

Nieuwe bevestigingsklemmen voor het bevestigen van verstekzagen op onderstellen DEBWST06 en DEAWST07



JM00000219

€ 80,50
excl. btw
€ 97,41
incl. btw

LS0816F

- Radiaal afkortzaag met maximale werkhoogte van 65 mm
- Nauwkeurige weergave van zaaglijn door gebruik van schaduwstelsysteem
- Voorzien van ingebouwde materiaalstop en zijdelingse steunen

LS1110F

- Radiaal afkortzaag met maximale werkhoogte van 91 mm
- Nauwkeurige weergave van zaaglijn door gebruik van schaduwstelsysteem
- Voorzien van ingebouwde materiaalstop en zijdelingse steunen

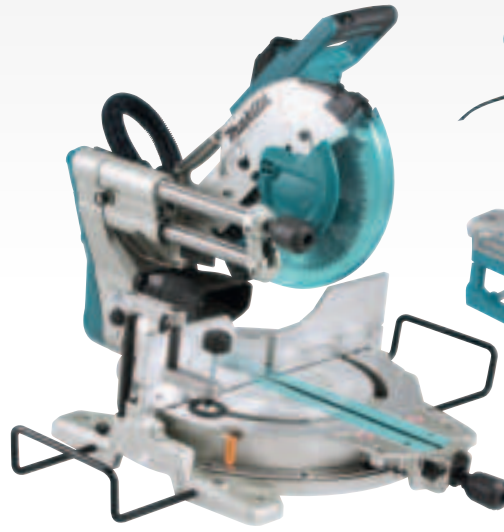

LS1019L



LS0816F

Verstekhoek	LS1219L - Snijhoek		
	45° links	0°	45° rechts
0°	71x363 mm	107x363 mm	54x363 mm
45° L EN R	71x255 mm	107x255 mm	54x255 mm
60° L EN R	-	107x178 mm	-
PLINTEN	-	171 mm	-

Verstekhoek	LS1019L - Snijhoek		
	45° links	0°	45° rechts
0°	61x279 mm	91x279 mm	43x279 mm
45° L EN R	61x197 mm	91x197 mm	43x197 mm
60° L EN R	-	91x139 mm	-
PLINTEN	-	133 mm	-

Verstekhoek	LS0815FL - Snijhoek		
	45° links	0°	5° rechts
0°	50x305 mm	65x305 mm	60x305 mm
45° L EN R	50x215 mm	65x215 mm	-
60° R	-	65x150 mm	-

Verstekhoek	LS1018LN - Snijhoek		
	45° links	90°	45° rechts
0°	50x310 mm	91x310 mm	31x310 mm
45° L EN R	50x220 mm	91x220 mm	31x220 mm
60° R	-	91x153 mm	-

Verstekhoek	LS0714FLB - Snijhoek		
	45° links	90°	45° rechts
0°	40x300 mm	52x300 mm	40x300 mm
45° L EN R	40x212 mm	52x212 mm	-
57° R	-	52x163 mm	-

NIEUW

NIEUW

	LS0815FLN	LS0816F	LS1018LN	LS1110F	LS0714LN	LS1019L	LS1219L
Nominaal vermogen	1400 W	1200 W	1430 W	1450 W	1010 W	1510 W	1800 W
Ø zaagblad	216 mm	216 mm	260 mm	260 mm	190 mm	260 mm	305 mm
DXT	-	-	-	-	-	✓	✓
Gewicht	14,2 kg	13,9	19,9 kg	16,4 kg	13,4 kg	26,3 kg	29,5 kg
Prijs in €	excl. btw	€ 369,00	€ 249,00	€ 479,00	€ 319,00	€ 579,00	€ 879,00
	incl. btw	€ 446,49	€ 301,29	€ 579,59	€ 385,99	€ 700,59	€ 1.063,59

DXT
Deep and Exact Cutting Technology

De gepatenteerde constructie met driefvoudige tandwieloverbrenging en uitsparing achter de flens laat toe om een groter deel van het zaagblad te benutten. Daardoor kunnen ook hoge plinten verticaal of in verstek afgekort worden.



ONDERSTEL AFKORT-VERSTEKZAGEN

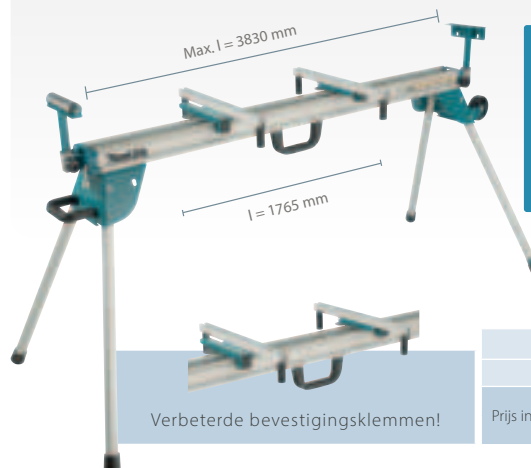

Verbeterde bevestigingsklemmen!

- Ideaal voor het zagen van lange materialen
- Vernieuwde bevestigingsklemmen met een veilig en handig kliksysteem om moeiteloos verstekzagen te installeren en te demonteren.
- Gemakkelijk te transporteren

DEAWST07

Afmetingen	1765 (l) x 750 (b) x 850 (h) mm
Max. lengte	3830 mm
Prijs in €	excl. btw
	incl. btw

HANDPALMVLAKSCHUURMACHINES



BO4565K



		BO4556K	BO4555K	BO4558	BO4565K
Nominaal vermogen		200 W	200 W	200 W	200 W
Afmetingen schuurvoet		112 x 102 mm	112 x 102 mm	112 x 102 mm	112 x 190 mm
Bevestiging		Klem	Velcro & klem	Klem	Velcro Driehoekspunt
Materiaal schuurvoet		Kunststof	Kunststof	Aluminium	Kunststof
Aantal schuurbewegingen		14000/min	14000/min	14000/min	14000/min
Schuuruitslag		1,5 mm	1,5 mm	1,5 mm	1,5 mm
Gewicht		1,1 kg	1,1 kg	1,2 kg	1,2 kg
Prijs in €	excl. btw	€ 99,00	€ 105,00	€ 109,00	€ 115,00
	incl. btw	€ 119,79	€ 127,05	€ 131,89	€ 139,15



VLAKSCHUURMACHINES MET VARIABLE SNELHEID



BO3711

		BO3711	BO4900VJ
Nominaal vermogen		190 W	330 W
Afmetingen schuurvoet		93 x 185 mm	115 x 232 mm
Aantal schuurbewegingen		4000-11000/min	4000-10000/min
Schuuruitslag		2,0 mm	2,6 mm
Gewicht		1,6 kg	2,7 kg
Prijs in €	excl. btw	€ 109,00	€ 275,00
	incl. btw	€ 131,89	€ 332,75

BANDSCHUURMACHINES



9403J:
Zeer krachtig,
ideaal voor intensief
schuurwerk

9911J
9403J



9403J



9911J



9032



		9911J	9924DB	9903J	9031	9032	9920J	9404J	9403J
Nominaal vermogen		650 W	850 W	1010 W	550 W	500 W	1010 W	1010 W	1200 W
Bandsnelheid		75-270 m/min	400 m/min	210-440 m/min	200-1000 m/min	300-1700 m/min	210-440 m/min	210-440 m/min	500 m/min
Schuurband		75 x 457 mm	75 x 610 mm	75 x 533 mm	30 x 533 mm	9 x 533 mm	75 x 610 mm	100 x 610 mm	100 x 610 mm
Gewicht		2,7 kg	4,8 kg	4,3 kg	2,1 kg	1,6 kg	4,5 kg	4,8 kg	5,7 kg
Prijs in €	excl. btw	€ 215,00	€ 295,00	€ 305,00	€ 315,00	€ 315,00	€ 335,00	€ 355,00	€ 385,00
	incl. btw	€ 260,15	€ 356,95	€ 369,05	€ 381,15	€ 381,15	€ 405,35	€ 429,55	€ 465,85

EXCENTRISCHE SCHUURMACHINES



BO5031K



BO5041K



BO6050J

	BO5031K	BO5041K	BO6030JX	BO6050J
Nominaal vermogen	300 W	300 W	310 W	750 W
Aantal schuurbewegingen	8000-24000/min	8000-24000/min	8000-20000/min	3200-13600/min
Schuuruitslag	2,8 mm	2,8 mm	3 mm	5,5 mm
Ø Schuurvoet	123 mm	123 mm	147 mm	147 mm
Gewicht	1,3 kg	1,4 kg	2,4 kg	2,6 kg
Prijs in €	excl. btw	€ 169,00	€ 189,00	€ 255,00
	incl. btw	€ 204,49	€ 228,69	€ 308,55

HAAKSE SCHUURMACHINE



SA7000C

		SA7000C
Nominaal vermogen		1600 W
Toerental onbelast		0-4000 t.p.m.
Ø schijf		180 mm
Gewicht		3,4 kg
Prijs in €	excl. btw	€ 245,00
	incl. btw	€ 296,45

EXCENTRISCHE POLIJSTMACHINE



PO6000C

		PO6000C
Nominaal vermogen		890 W
Aantal schuurbewegingen		0-13600 /min.
Ø schijf		150 mm
Schuuruitslag		5,5 mm
Gewicht		2,7 kg
Prijs in €	excl. btw	€ 329,00
	incl. btw	€ 398,09

SCHUUR- EN POETSMACHINE



9237CB

		9237CB
Nominaal vermogen		1200 W
Toerental		0-3200 t.p.m.
Ø schijf		180 mm
Gewicht		3,4 kg
Prijs in €	excl. btw	€ 319,00
	incl. btw	€ 385,99

BORSTELSCHUURMACHINE



9741J

		9741J
Nominaal vermogen		860 W
Toerental		3500 t.p.m.
Gewicht		4,2 kg
Prijs in €	excl. btw	€ 539,00
	incl. btw	€ 652,19

GASNAGELPISTOOL VOOR
AFWERKNAGELS 16 GA



GF600SE

Accu	7,2 V / 1,0 Ah	
Gemiddelde laadtijd	30 min	
Doorsnede nagel	1,6 mm	
Lengte nagel	15-64 mm	
Gewicht	2,2 kg	
Prijs in €	excl. btw	€ 579,00
	incl. btw	€ 700,59

GASNAGELPISTOOL
VOOR BETON



GN420CSE

Accu	7,2 V / 1,0 Ah	
Gemiddelde laadtijd	30 min	
Doorsnede nagel	2,6-3,0 mm	
Lengte nagel	15-40 mm	
Gewicht	3,5 kg	
Prijs in €	excl. btw	€ 815,00
	incl. btw	€ 986,15

GASNAGELPISTOOL VOOR HOUT



GN900SE

Accu	7,2 V / 1,0 Ah	
Gemiddelde laadtijd	30 min	
Doorsnede nagel	2,9-3,3 mm	
Lengte nagel	50-90 mm	
Gewicht	3,3 kg	
Prijs in €	excl. btw	€ 609,00
	incl. btw	€ 736,89

COMPRESSOR 230V



MAC210Q

- Compacte 1 pk luchtcompressor, ideaal voor gebruik in combinatie met kleine perslucht-gereedschappen zoals nagelaars
- Laag toerental: vermindert het geluidsniveau en verlengt de levensduur van de pomp
- Compacte rolkooiconstructie, draagbaar
- Olivrijne pomp met twee cilinders
- Twee grote manometers

NIEUW

MAC210Q

Voeding	230 V AC	
Luchtdebiet	48 l/min @ 6,2 bar	
Werkdruk	0 - 9,3 bar	
Tankinhoud	7,6 l	
Geluidsdruk	60 dB (A)	
Gewicht	22 kg	
Prijs in €	excl. btw	€ 349,00
	incl. btw	€ 422,29

Leverbaar vanaf mei

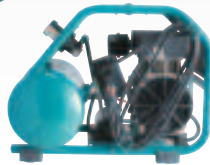

PNEUMATISCH CONSTRUCTIE-
NAGELPISTOOL 21°



AN924

Werkdruk	4,9-8,3 bar	
Doorsnede nagel	3,76 mm	
Lengte nagel	50-90 mm	
Gewicht	3,8 kg	
Prijs in €	excl. btw	€ 325,00
	incl. btw	€ 393,25

MINIBRADPISTOOL 18 GA



AF506

Werkdruk	4,8-8,3 bar	
Draadkaliber	18 Ga	
Ø Nagelkop	2,0 mm	
Doorsnede nagel	1,2 mm	
Lengte nagel	15-50 mm	
Gewicht	1,4 kg	
Prijs in €	excl. btw	€ 125,00
	incl. btw	€ 151,25

BRADPISTOOL 16 GA



AF601

Werkdruk	0,49 - 8,3 bar	
Draadkaliber	16 Ga	
Doorsnede nagel	1,6 mm	
Lengte nagel	25 - 64 mm	
Gewicht	1,7 kg	
Prijs in €	excl. btw	€ 189,00
	incl. btw	€ 228,69

PNEUMATISCH CONSTRUCTIENAGELPISTOOL 34°



AN943K

Werkdruk	4,5-8,5 bar	
Ø Nagelkop	7,0 mm	
Doorsnede nagel	2,9-3,3 mm	
Lengte nagel	50-90 mm	
Gewicht	3,9 kg	
Prijs in €	excl. btw	€ 435,00
	incl. btw	€ 526,35

LASERAFSTANDSMETER



LD080PI



LD030P



	LD030P	LD050P	LD080PI
Bereik	30 m	50 m	80 m
Gewicht	0,1 kg	0,1 kg	0,1 kg
Prijs in €	excl. btw	€ 79,00	€ 105,00
	incl. btw	€ 95,59	€ 127,05

ROTARENDE LASER



PROMO
gratis statief 2,7 m
t.w.v. € 267,50



Inclusief ontvanger, bril voor laser, afstandsbediening en wandbevestiging

		SKR200Z
Rotatiesnelheid		0-600 t.p.m.
Bereik		100 m
Gewicht		1,6 kg
Prijs in €	excl. btw	€ 689,00
	incl. btw	€ 833,69

ACCU MUURSCANNER



De DWD181 gebruikt radartechnologie om nauwkeurig metaal, hout, elektrische bekabeling en andere objecten in wanden en vloeren te detecteren

4,1 inch kleurenscherm



		DWD181ZJ
Spanning		14,4V/18 V
Max. detectiediepte		25 - 180 mm
Tolerantie detectiediepte		± 5 mm
Minimum detecteerbare afstand tussen objecten		40 mm
Bijgeleverde lader/accu		-
Gewicht zonder accu		1,0 kg
Prijs in €	excl. btw	€ 1.239,00
	incl. btw	€ 1.499,19

KRUISLIJN- EN LIJNLASERS (CXT)

SK105DZ, SK105GDZ,
SK106DZ & SK106GDZ
PROMO
Incl. BL1021B + DC105B



SK105DZ

SK106GDZ

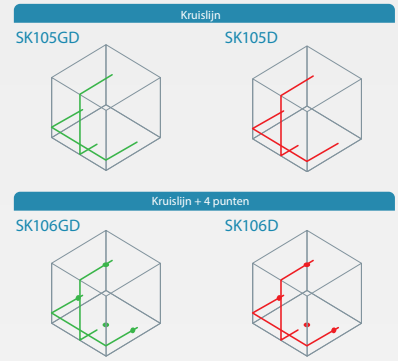

	SK105DZ	SK105GDZ	SK106DZ	SK106GDZ
Kleur	Rood	Groen	Rood	Groen
Projecties	1 H - 1 V	1 H - 1 V	1 H - 1 V + 4 punten	1 H - 1 V + 4 punten
Nauwkeurigheid	+3 mm/10 m	+3 mm/10 m	+3 mm/10 m	+3 mm/10 m
Bereik	25 m	25 m	25 m	25 m
Bijgeleverde accu's	1 x BL1021B + DC105B	1 x BL1021B + DC105B	1 x BL1021B + DC105B	1 x BL1021B + DC105B
Gewicht	0,67 kg	0,67 kg	0,69 kg	0,69 kg
Prijs in €	excl. btw	€ 209,00	€ 375,00	€ 329,00
	incl. btw	€ 252,89	€ 453,75	€ 398,09

SK10GD/SK20GD/SK40GD

- Groene laser met hoge helderheid
- Uiterst nauwkeurig
- Stevige constructie, beschermingsklasse IP54

<p>Horizontaal / 4-Verticale lijnen</p> <p>SK40GD</p>	<p>Horizontaal / 2-Verticale lijnen</p> <p>SK20GD</p>	<p>Kruislijn + Punt</p> <p>SK10GD</p>
---	---	---------------------------------------

SK10GDZ, SK20GDZ, SK40GDZ
SK209GDZ & SK312GDZ
PROMO
gratis powerpack 197658-5
€ 159,00



SK209GDZ

SK312GDZ

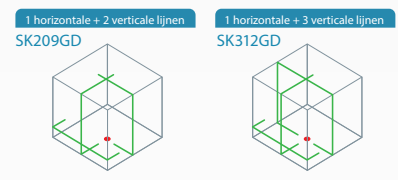

	SK10GDZ	SK20GDZ	SK40GDZ	SK209GDZ	SK312GDZ
Kleur	Groen	Groen	Groen	Groen	Groen
Projecties	1 H - 1 V	1 H - 2 V	1 H - 4 V	1 H - 2 V	1 H - 3 V
	+ loodpunt	+ loodpunt	+ loodpunt	+ loodpunt	+ loodpunt
Nauwkeurigheid	±1 mm/10 m	±1 mm/10 m	±1 mm/10 m	+1 mm/10 m	+1 mm/10 m
Bereik	-	-	-	-	-
Bijgeleverde accu's	2x BL1021B + DC105B	2x BL1021B + DC105B	2x BL1021B + DC105B	2x BL1021B + DC105B	2x BL1021B + DC105B
Gewicht	1,4 - 1,6 kg	1,4 - 1,6 kg	1,4 - 1,6 kg	1,5 - 1,6 kg	1,5 - 1,6 kg
Prijs in €	excl. btw	€ 489,00	€ 589,00	€ 805,00	€ 979,00
	incl. btw	€ 591,69	€ 712,69	€ 974,05	€ 1.184,59

KRUISLIJN- EN LIJNLASERS (CXT)

SK700DZ/SK700GDZ:

- 3x 360° laser (3 stralen: 1 horizontaal 360° + 2 verticaal 360°).
- Zeer hoge nauwkeurigheid.
- Blokkeerstand voor projectie van schuine lijnen en voor transport.
- Zeer grote autonomie dankzij de 12Vmax CXT batterij.
- IP54 bescherming.



Via een sneldraaiende conische spiegel wordt de laserstraal over 360° geprojecteerd.

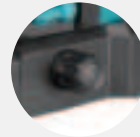

Fijnafstelling: Via een knop op de basis kan de unit zeer precies over een bereik van 10° gedraaid worden. De bevestiging is excentrisch zodat de kruising van de lijnen bij het draaien op hetzelfde punt blijft.

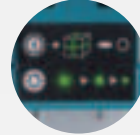

Helderheidsinstelling
Via de 3 helderheidsinstellingen (100% – 75% – 50%) kan de intensiteit van de laser perfect aangepast worden aan de omstandigheden.

Hoge intensiteit
De SK700GDZ met krachtige groene laser biedt een uitstekende zichtbaarheid, ook in een omgeving met invallend daglicht.

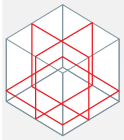

SK700DZ



SK700GDZ



SK700DZ & SK700GDZ
INCLUSIEF:
Powerpack 197658-5
t.w.v. € 159,00



OPTIONEEL CP0000001
ADP09 Batterij adapter voor SK700
Werkt met 8 x 1,5V AA-batterijen
excl btw: € 29,90
incl btw: € 36,18



	SK700DZ	SK700GDZ
Kleur	Rood	Groen
Projecties	3 x 360° rood	3 x 360° groen
Nauwkeurigheid	±2mm/10m	±2mm/10m
Bereik	25 m	35 m
Bijgeleverde accu's	2x BL1021B + DC105B	2x BL1021B + DC105B
Gewicht	0,99 – 1,2 kg	0,99 – 1,2 kg
Prijs in €	excl. btw	€ 479,00
	incl. btw	€ 579,59
Prijs in €	excl. btw	€ 609,00
	incl. btw	€ 736,89

Accessories

TK0LM2000F
Statief 400 - 1140 mm
excl btw: € 71,40
incl btw: € 86,39



TK0LM4001F
Statief 680 - 1800 mm
excl btw: € 134,60
incl btw: € 162,87



TK0LM5030F
Statief 780 - 2900 mm
excl btw: € 195,60
incl btw: € 236,68



LE00870137
Muur- en plafondbevestiging SK105, SK106, SK700
excl btw: € 75,50
incl btw: € 91,36



TK00ET03F1
Muur- en plafondbevestiging SK10, SK20, SK40, SK209, SK312
excl btw: € 235,00
incl btw: € 284,35



LE00855702
Laserlijnontvanger (80 m) SK105, SK106, SK700
excl btw: € 230,60
incl btw: € 279,03



TK0LDG501G
Laserlijnontvanger SK10,SK20, SK40
excl btw: € 192,80
incl btw: € 233,29



TK0LDG301G
Laserlijnontvanger SK209, SK312
excl btw: € 292,20
incl btw: € 353,56

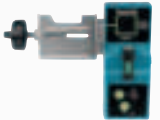

DECADP05
Adapter voor LXT batterijen
excl btw: € 35,20
incl btw: € 42,59



199178-5
USB voedingskabel voor ADP05 (SK105 / SK106)
excl btw: € 10,80
incl btw: € 13,07



199010-3
USB voedingskabel voor ADP05 (SK209 / SK312)
excl btw: € 13,80
incl btw: € 16,70



DLM330

ACCU GRASMAAIERS 18V

LICHT EN COMPACT
KAN VERTICAAL GESTOCKEERD
WORDEN
IDEAAL VOOR KLEINE OPPERVLAKTES



DLM330SM



		DLM330Z	DLM330SM
Spanning		1 x 18V	1 x 18V
Bijgeleverde accu's		-	1 x accu 4,0 Ah
Bijgeleverde Lader		-	DC18SD
Max. uitgangsvermogen		450 W	450 W
Maai breedte		33 cm	33 cm
Aanbevolen terreinoppervlakte		200 - 450 m ²	200 - 450 m ²
Inhoud opvangbak		30 l	30 l
Chassis		Polypropyleen	Polypropyleen
Zelftrekkend			
Mulching		✓	✓
Gewicht		11,6 - 12,5 kg	11,6 - 12,5 kg
Prijs in €	excl. btw	€ 185,95	€ 243,80
	incl. btw	€ 225,00	€ 295,00

DLM432

ACCU GRASMAAIERS 2 x 18V



DLM432PT2



		DLM432Z	DLM432PT2
Spanning		2 x 18V	2 x 18V
Bijgeleverde accu's		-	2 x accu 5,0 Ah
Bijgeleverde Lader		-	DC18RD
Max. uitgangsvermogen		900 W	900 W
Maai breedte		43 cm	43 cm
Aanbevolen terreinoppervlakte		300 - 575 m ²	300 - 575 m ²
Inhoud opvangbak		50 l	50 l
Chassis		Polypropyleen	Polypropyleen
Zelftrekkend		-	-
Mulching		Optioneel	Optioneel
Gewicht		14,3 kg	14,3 kg
Prijs in €	excl. btw	€ 384,30	€ 536,36
	incl. btw	€ 465,00	€ 649,00

DLM480 / DLM481 / DLM539

ACCU GRASMAAIERS 2 x 18V

PROMO

Gratis BL1850B
na online registratie
DLM481CT2 &
DLM539CT2



DLM481CT2

DLM539CT2

		DLM480CT2	DLM481CT2	DLM539CT2
Spanning		2 x 18V	2 x 18V	2 x 18V
Bijgeleverde accu's		2 x accu 5,0 Ah	2 x accu 5,0 Ah	2 x accu 5,0 Ah
Bijgeleverde Lader		DC18SH	DC18SH	DC18SH
Max. uitgangsvermogen		860 W	860 W	860 W
Maai breedte		48 cm	48 cm	53,4 cm
Aanbevolen terreinoppervlakte		400 - 800 m ²	400 - 800 m ²	500 - 1000 m ²
Inhoud opvangbak		62 l	62 l	70 l
Chassis		Polypropyleen	Polypropyleen	Polypropyleen
Zelftrekkend		-	✓	✓
Mulching		✓	✓	✓
Gewicht		24,5 - 26,8 kg	27,1 - 29,3 kg	28,0 - 30,5 kg
Prijs in €	excl. btw	€ 701,65	€ 784,30	€ 825,62
	incl. btw	€ 849,00	€ 949,00	€ 999,00

DLM463

ACCU GRASMAAIERS 2 x 18V



DLM463PT2

PROMO

Gratis BL1850B
na online registratie

18V + 18V → 36V

XPT
EXTREME PROTECTION TECHNOLOGY

BL
MOTOR

		DLM463Z	DLM463PT2
Spanning		2x 18V	2x 18V
Bijgeleverde accu's		-	DC18RD
Bijgeleverde lader		-	2x 5,0 Ah
Max. uitgangsvermogen		1450 W	1450 W
Maibreedte		46 cm	46 cm
Aanbevolen terreinoppervlakte		800 - 1600 m ²	800 - 1600 m ²
Inhoud opvangbak		60 l	60 l
Chassis		Staal	Staal
Zelftrekkend		-	-
Mulching		✓	✓
Gewicht		25,3 - 27,6 kg	25,3 - 27,6 kg
Prijs in €	excl. btw	€ 594,21	€ 866,94
	incl. btw	€ 719,00	€ 1.049,00

DLM465

ACCU GRASMAAIERS 2 x 18V

BL MOTOR XPT
EXTREME PROTECTION TECHNOLOGY

18V + 18V → 36V

PROMO

Gratis BL1850B
na online registratie



DLM465PT2

		DLM465Z	DLM465PT2
Spanning		2x 18V	2x 18V
Bijgeleverde accu's		-	2x 5,0 Ah
Bijgeleverde lader		-	DC18RD
Max. uitgangsvermogen		1600 W	1600 W
Maibreedte		46 cm	46 cm
Aanbevolen terreinoppervlakte		1600 - 1800 m ²	1600 - 1800 m ²
Inhoud opvangbak		60 l	60 l
Chassis		Staal	Staal
Zelftrekkend		✓	✓
Mulching		✓	✓
Gewicht		35,3 - 39,0 kg	35,3 - 39,0 kg
Prijs in €	excl. btw	€ 904,96	€ 1.156,20
	incl. btw	€ 1.095,00	€ 1.399,00

De **aanbevolen maaioffervlakte** is de oppervlakte waar de machine qua vermogen, mechaniek en werkbreedte voor geschikt is. Opgelet, dit komt niet noodzakelijk overeen met de autonomie, die afhankelijk is van het type batterijen dat gebruikt wordt en de maaioffstandigheden (de hoogte en dichtheid van het gras, de helling van het terrein enz.) Dus het kan voorkomen dat de accu's tussenin bijgeladen moeten worden om de volledige oppervlakte te kunnen maaien.

DLM536 / DLM533

ACCU GRASMAAIERS 2 x 18V

PROMO

Gratis BL1850B
na online registratie

18V + 18V → 36V

XPT
EXTREME PROTECTION TECHNOLOGY

BL
MOTOR



DLM536Z



DLM533Z

		DLM536Z	DLM533Z
Spanning		2x 18V	2x 18V
Bijgeleverde lader		-	-
Bijgeleverde accu's		-	-
Max. uitgangsvermogen		1600 W	1600 W
Maibreedte		53 cm	53 cm
Aanbevolen terreinoppervlakte		1600 - 1800 m ²	1600 - 1800 m ²
Chassis		Staal	Aluminium
Zelftrekkend		✓	✓
Inhoud opvangbak		60 l	60 l
Mulching		✓	✓
Gewicht		39,0 - 42,8 kg	39,0 - 42,8 kg
Prijs in €	excl. btw	€ 933,06	€ 1.313,22
	incl. btw	€ 1.129,00	€ 1.589,00

LM003G / LM004G

ACCU GRASMAAIER 40VMAX

PROMO

Gratis BL4040 na online registratie LM003GM102 en LM004GM102



LM003GM102



LM004GM102

Plaatsbesparend verticaal opbergen

- LM003G & LM004G**
- Budgetvriendelijk model met één 40Vmax accu
 - Kunststof maaidek
 - Gemakkelijk te bedienen schakelhendel met lichte veer
 - Hoogteregeling in 10 stappen
 - Verbeterde grasopvang, standaard geleverd met mes voor zowel opvangen als mulchen
 - De duwhendel kan gemakkelijk ontgrendeld en opgeplooid worden
 - Kan zeer compact verticaal gestockeerd worden
 - Mulchplug inbegrepen
 - Speciaal mes geoptimaliseerd voor mulchen in optie verkrijgbaar

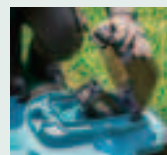

Werkt met één 40Vmax accu

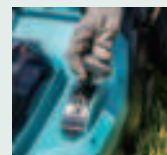

Centrale hoogteregeling

NIEUW

NIEUW

NIEUW

NIEUW

	LM003GZ	LM003GM102	LM004GZ	LM004GM102	
Spanning	36 V (40Vmax)	36 V (40Vmax)	36 V (40Vmax)	36 V (40Vmax)	
Bijgeleverde accu's	-	1x BL4040	-	1x BL4040	
Bijgeleverde lader	-	DC40RA	-	DC40RA	
Max. uitgangsvermogen	740 W	740 W	740 W	740 W	
Maai breedte	380 mm	380 mm	430 mm	430 mm	
Aanbevolen terreinoppervlakte	75 - 780 m ²	75 - 780 m ²	100 - 830 m ²	100 - 830 m ²	
Toerental onbelast	3800 min	3800 min	3800 min	3800 min	
Maaihoogte	20 - 70 mm	20 - 70 mm	20 - 70 mm	20 - 70 mm	
Opvangcapaciteit	40 l	40 l	50 l	50 l	
Mulching	✓	✓	✓	✓	
Chassis	Polypropyleen	Polypropyleen	Polypropyleen	Polypropyleen	
Gewicht	14,9 - 17,3 kg	14,9 - 17,3 kg	15,6 - 18,2 kg	15,6 - 18,2 kg	
Prijs in €	excl. btw	€ 329,75	€ 508,26	€ 338,02	€ 528,10
	incl. btw	€ 399,00	€ 615,00	€ 409,00	€ 639,00

LM001G / LM002G

ACCU GRASMAAIERS 40VMAX



PROMO

Gratis BL4040 direct geleverd bij LM001GZ & LM002GZ



	LM001GZ	LM002GZ	
Spanning	36 V (40Vmax)	36 V (40Vmax)	
Max. uitgangsvermogen	1900 W	1900 W	
Maai breedte	48 cm	53 cm	
Aanbevolen terreinoppervlakte	1600 - 1800 m ²	1700 - 2000 m ²	
Toerental onbelast	2500 / 3200 min ⁻¹	2300 / 2800 min ⁻¹	
Maaihoogte	20 - 100 mm	20 - 100 mm	
Rijsnelheid	1,5 - 5,0 km/h	1,5 - 5,0 km/h	
Opvangcapaciteit	62 l	70 l	
Gewicht	28,0 - 33,0 kg	29,5 - 34,7 kg	
Prijs in €	excl. btw	€ 908,26	€ 990,91
	incl. btw	€ 1.099,00	€ 1.199,00

UV001G XGT 40Vmax
ACCU VERTICUTEERMACHINE
40VMAX



Hoogteregeling Compact opbergen



De moshark is een cilinder met fijne metalen pinnen die het gras uitkamt zonder insnijdingen te maken in de bodem. Wordt gebruikt om oud gras en mos (de viltlaag) uit het gras te verwijderen. Daardoor krijgt het gras meer licht en lucht.



Het verticuteermes wordt gebruikt om de oppervlakte wortels door te snijden/hetgeen de groei stimuleert en om de water- en luchtinfiltratie te verbeteren.



- Uitgerust met krachtige BL motor op 40Vmax
- Werkt met één of twee XGT accu's, het overschakelen gaat automatisch (accu's niet mee geleverd)
- De werkdiepte is met één knop in te stellen van -12 tot 5 mm, 18 stappen
- Standaard geleverd met verticuteerrol en een accessoire voor het ontmossen zonder snijden (moshark)
- De messen met hoge duurzaamheid zijn speciaal ontworpen om lang scherp te blijven
- Zeer trillingsarm door symmetrische uitlijning van de messen en het gebruik van tegengewichten
- Inklapbare handgreep, de machine kan zeer compact opgeborgen worden
- Het kunststof onderdek mag met water afgespoeld worden voor het gemakkelijk reinigen

NIEUW

UV001GZ

Spanning	36 V (40Vmax)
Max. uitgangsvermogen	1700 W
Werkbreedte	380 mm
Werkdiepte	-5 tot -12 mm
Capaciteit opvang	50 l
Gewicht	18,7 - 23,8 kg
Prijs in €	excl. btw
	incl. btw



UV3200 / UV3600
ELEKTRISCHE VERTICUTEERMACHINES



UV3200

UV3600

		UV3200	UV3600
Nominaal vermogen		1300 W	1800 W
Werkbreedte		32 cm	36 cm
Polypropyleen chassis		✓	✓
Gewicht		15 kg	18,3 kg
Prijs in €	excl. btw	€ 185,95	€ 271,90
	incl. btw	€ 225,00	€ 329,00

Accessoires voor verticuteerders - verluchters

	Ref.	Lengte	Geschikt voor model	Standaard meegeleverd	Prijs euro excl. btw	Prijs euro incl. btw
	Complete verticuteerrol voor UV3200					
	652024718	320 mm	UV3200	✓	€ 26,50	€ 32,07
	Complete verluchterrol voor UV3200					
	652024719	320 mm	UV3200		€ 30,50	€ 36,91
	Complete verticuteerrol voor UV3600					
	652024746	360 mm	UV3600	✓	€ 29,50	€ 35,70
	Complete verluchterrol voor UV3600					
	652024750	360 mm	UV3600		€ 24,55	€ 29,70
	Gecombineerde rol om te verluchten en verticuteren voor UV3600					
	652024749	360 mm	UV3600		€ 79,00	€ 95,59
	Verticuteerrol UV001G					
	1913J5-0	380 mm	UV001G	✓	€ 60,00	€ 72,60
	Moshark UV001G					
	1913J7-6	380 mm	UV001G	✓	€ 60,00	€ 72,60

DUR193

ACCU GRASTRIMMER 18V



DUR193RF

	DUR193Z	DUR193RF
Spanning	18 V	18 V
Bijgeleverde accu's	-	1 x accu 3,0 Ah
Bijgeleverde lader	-	DC18RC
Snelheden	1	1
BL motor	-	-
ADT	-	-
AFT	-	-
Handgreep	Rond ("D")	Rond ("D")
Schacht	Telescopisch	Telescopisch
Max. uitgangsvermogen	280 W	280 W
Gewicht	2,3 - 2,6 kg	2,3 - 2,6 kg
Prijs in €	excl. btw	€ 106,61
	incl. btw	€ 129,00
Prijs in €	excl. btw	€ 205,79
	incl. btw	€ 249,00

DUR189

ACCU GRASTRIMMER 18V



DUR189RFE

	DUR189Z	DUR189RFE
Bijgeleverde accu's	-	2x accu 3,0 Ah
Bijgeleverde lader	-	DC18RC
Snelheden	3	3
ADT	✓	✓
AFT	-	-
Handgreepvorm	D	D
Max. uitgangsvermogen	240 W	240 W
Gewicht	3,0 - 3,3 kg	3,0 - 3,3 kg
Prijs in €	excl. btw	€ 210,74
	incl. btw	€ 255,00
Prijs in €	excl. btw	€ 400,83
	incl. btw	€ 485,00

DUR194

ACCU GRASTRIMMER 18V



- COMPATIBEL MET DRAADKOP, KOP MET NYLON MESSEN EN METALEN 8-TANDS MAAIBLAD
- MET UNIVERSELE BESCHERMKAP



DUR194SFX2

	DUR194ZX3	DUR194SFX2	DUR194RTX1
Spanning	18 V	18 V	18 V
Bijgeleverde accu's	-	1x accu 3,0 Ah	1x accu 5,0 Ah
Bijgeleverde lader	-	DC18SD	DC18RC
Snelheden	2	2	2
BL motor	-	-	-
ADT	-	-	-
AFT	-	-	-
Handgreep	D	D	D
Max. uitgangsvermogen	230 W	230 W	230 W
Gewicht	2,6 - 2,9 kg	2,6 - 2,9 kg	2,6 - 2,9 kg
Prijs in €	excl. btw	€ 156,20	€ 260,33
	incl. btw	€ 189,00	€ 315,00
Prijs in €	excl. btw	€ 288,43	€ 349,00
	incl. btw	€ 349,00	€ 428,00

DUR190 / DUR191

ACCU GRASTRIMMERS 18V

SCHACHT IN EÉN DEEL (DUR190)

DEMONTTEERBARE SCHACHT VOOR TRANSPORT (DUR191)



DUR190UT11

DUR191LZX9

PROMO

Gratis BL1850B bij DUR190UT11 na online registratie



- DUR190UT11 INCLUSIEF MAAIMES
- EASY FILL MAAIKOP OP DUR190UZX9, DUR190UT11 EN DUR191LZX9

	DUR190UZX9	DUR190UT11	DUR191LZX3	DUR191LZX9
Spanning	18V	18V	18V	18V
Bijgeleverde accu's	-	1 x accu 5,0 Ah	-	-
Lader	-	DC18SD	-	-
Snelheden	3	3	3	3
ADT	-	✓	✓	✓
AFT	-	✓	✓	✓
Handgreepvorm	U	U	D	D
Max. uitgangsvermogen	240 W	240 W	240 W	240 W
Gewicht	3,4 kg	3,1 kg	3,1 kg	3,1 kg
Prijs in €	excl. btw	€ 230,58	€ 362,81	€ 252,07
	incl. btw	€ 279,00	€ 439,00	€ 305,00
Prijs in €	excl. btw	€ 252,07	€ 362,81	€ 252,07
	incl. btw	€ 305,00	€ 439,00	€ 305,00

DUR368 / DUR369
 ACCU BOSMAAIERS 2X18V



PROMO
 Gratis BL1850B
 na online registratie



DUR369AZ

DUR368LZ

		DUR368LZ	DUR368AZ	DUR369AZ
Spanning		2x 18V	2x 18V	2x 18V
Max. toerental onbelast		6500 t.p.m.	6500 t.p.m.	7000 t.p.m.
Bijgeleverde accu's		-	-	-
Bijgeleverde lader		-	-	-
Snelheden		3	3	3
ADT		✓	✓	✓
AFT		✓	✓	✓
Handgreep		Rond ("D")	Dubbel ("U")	Dubbel ("U")
Max. uitgangsvermogen		550 W	550 W	1000 W
Gewicht		3,9 - 4,5 kg	4,1 - 4,7 kg	5,9 - 6,5 kg
Prijs in €	excl. btw	€ 313,22	€ 354,55	€ 412,40
	incl. btw	€ 379,00	€ 429,00	€ 499,00

UR016G / UR017G
 ACCU BOSMAAIERS 40VMAX



UR016GZ

		UR016GZ	UR017GZ
Spanning		36V (40Vmax)	36V (40Vmax)
Bijgeleverde accu's		-	-
Bijgeleverde lader		-	-
Toerental onbelast		3500/5300/ 6500 min ⁻¹	3500/5300/ 6500 min ⁻¹
Handgreepvorm		Dubbel ("U")	Rond ("D")
ADT		✓	✓
AFT		✓	✓
Max. uitgangsvermogen		600 W	600 W
Gewicht		4,6 - 5,4 kg	4,2 - 4,8 kg
Prijs in €	excl. btw	€ 362,81	€ 346,28
	incl. btw	€ 439,00	€ 419,00

UR002G / UR006G / UR007G
 ACCU BOSMAAIERS 40VMAX

PROMO

Gratis AS001GZ na
 online registratie
 UR006GM101



UR002GZ01

UR006GM101



		UR002GZ01	UR006GZ02	UR006GM102	UR007GZ01
Spanning		36V (40Vmax)	36V (40Vmax)	36V (40Vmax)	36V (40Vmax)
Max. toerental onbelast		3500 - 5300 - 6500 min ⁻¹	4600 - 5500 - 7000 min ⁻¹	4600 - 5500 - 7000 min ⁻¹	4600 - 5500 - 7000 min ⁻¹
Snelheden		3 + auto	3 + auto	3 + auto	3 + auto
Handgreepvorm		Dubbel ("U")	Dubbel ("U")	Dubbel ("U")	Rond ("D")
ADT		✓	✓	✓	✓
AFT		✓	✓	✓	✓
Bijgeleverde accu's		0	0	1x BL4040	0
Bijgeleverde lader		0	0	1 x DC40RA	0
Max. uitgangsvermogen		550 W	1 kW	1 kW	1 kW
Gewicht		4,6 - 5,3 kg	5,7 - 6,3 kg	5,7 - 6,3 kg	5,7 - 6,3 kg
Prijs in €	excl. btw	€ 395,87	€ 420,66	€ 701,65	€ 437,19
	incl. btw	€ 479,00	€ 509,00	€ 849,00	€ 529,00

UR012G

ACCU BOSMAAIER 2 x 40VMAX



UR012GZ02

UR012GZ02

Spanning	2 x 40Vmax	
Max. toeren onbelast	3500 - 5000 - 6800 min ⁻¹	
Snelheden	3 + auto	
ADT	✓	
AFT	✓	
Bijgeleverde accu's	-	
Bijgeleverde lader	-	
Max. uitgangsvermogen	2,0 kW	
Gewicht	8,0 - 9,3 kg	
Prijs in €	excl. btw	€ 742,98
	incl. btw	€ 899,01

Max. uitgangsvermogen
2,0 kW

UR013G / UR014G

ACCU BOSMAAIERS 40VMAX



UR013GZ04

UR013G/UR014G

Extra hoog koppel in "High torque mode", bijzonder geschikt voor zware toepassingen

UR014G

- enkel te gebruiken met draadkop
- de draairichting is omkeerbaar



UR014GZ

UR013GZ04 UR014GZ

Spanning	36V (40Vmax)	36V (40Vmax)	
Toerental onbelast	3500 - 6700 min ⁻¹	4000 - 5000 min ⁻¹	
Bijgeleverde accu's	-	-	
Bijgeleverde lader	-	-	
Handgreepvorm	Dubbel ("U")	Rond ("D")	
ADT	-	-	
AFT	✓	✓	
Max. uitgangsvermogen	1500 W	1500 W	
Gewicht	5,9 - 7,2 kg	5,5 - 6,7 kg	
Prijs in €	excl. btw	€ 528,10	€ 511,57
	incl. btw	€ 639,00	€ 619,00

HW001GZ

ACCU HOGEDRUKREINIGER 40VMAX



HW001G

- Hoge reinigingskracht met goede balans tussen druk en debiet
- Voeding middels één of twee 40Vmax accu's
- 3 vermogensstanden
- Telescopisch handvat en compartiment voor de accessoires
- Autonomie bij max. vermogen: 18 min (2x BL4050F)

HW001GZ

Spanning	36V (40Vmax)	
Bijgeleverde accu's	-	
Lader	-	
Werkdruk	30/55/85 bar	
Debiet	3,0/4,2/5,5 l/min	
Lengte hogedrukslang	6 m	
Gewicht	10,1 - 13,2 kg	
Prijs in €	excl. btw	€ 718,18
	incl. btw	€ 869,00

DHW080

ACCU HOGEDRUKREINIGER



Compatibel

Er is een breed assortiment aan hulpstukken beschikbaar, ze zijn ook compatibel met de HW1200 / HW1300.

Capaciteit watertank

50 l

Werkdruk

30/55 bar

Debiet

4,0/5,5 l/min

DHW080ZK

Spanning	2 x 18 V	
Bijgeleverde accu's	-	
Lader	-	
Werkdruk	30/55 bar	
Debiet	4,0/5,5 l/min	
Inhoud watertank	50 l	
Gewicht	7,1-7,7 kg	
Prijs in €	excl. btw	€ 569,42
	incl. btw	€ 689,00

US053D / DUS054

ACCU COMPACTE SPROEIER

- Schoudergedragen model met een 5 l tank
- De twee spuitmondjes zijn afzonderlijk te activeren voor small of breed sproeien.
- Uitschuifbare spuitlans: 0,5 – 0,7 m
- Enkel geschikt voor het verwerken van op water gebaseerde gazon- en tuin chemicaliën.



US054

CXT LXI XPT

		US053DZ	DUS054Z
Spanning		12Vmax	18V
Bijgeleverde accu's		-	-
Tankinhoud		5 l	5 l
Debiet		0,46-0,6 l/min	0,46-0,6 l/min
Max. druk		3,0 bar	3,0 bar
Afmetingen		340 x 183 x 360 mm	340 x 183 x 360 mm
Gewicht		2,9 - 3,0 kg	3,2 - 3,5 kg
Prijs in €	excl. btw	€ 185,95	€ 185,95
	incl. btw	€ 225,00	€ 225,00

DUS108 / DUS158

ACCU RUGSPROEIER

- Ruggedragen modellen.
- Standaard geleverd met enkele- en dubbele sproeikop.
- Enkel geschikt voor het verwerken van op water gebaseerde gazon- en tuin chemicaliën.



DUS108Z

DUS158Z

XPT

		DUS108Z	DUS158Z
Spanning		18V	18V
Bijgeleverde accu's		-	-
Tankinhoud		10 l	15 l
Debiet		0,8 - 1,3 l/min	0,8 - 1,3 l/min
Max. druk		5,0 bar	5,0 bar
Afmetingen		325 x 237 x 439 mm	325 x 237 x 517 mm
Gewicht		5,6 - 5,9 kg	5,9 - 6,2 kg
Prijs in €	excl. btw	€ 271,26	€ 296,69
	incl. btw	€ 329,00	€ 359,00

PF0800 / PF1100

DOMPELPOMPEN VOOR ZUIVER WATER



PF0800

PF1010

PF1100

PF1110

PF1010 / PF1110

DOMPELPOMPEN VOOR VUIL WATER

		PF0800	PF1010	PF1100	PF1110
Nominaal vermogen		800 W	1100 W	1100 W	1100 W
Max. debiet		220 l/min	240 l/min	250 l/min	250 l/min
Max. opvoerhoogte		9 m	10 m	9 m	10 m
Gewicht		6,1 kg	6,6 kg	6,7 kg	7,0 kg
Prijs in €	excl. btw	€ 98,35	€ 106,21	€ 131,40	€ 139,67
	incl. btw	€ 119,00	€ 129,00	€ 158,99	€ 169,00

HW1200 / HW1300 / HW131 / HW151

ELEKTRISCHE HOGEDRUKREINIGERS



HW1300

HW1300

HW131

		HW1200	HW1300	HW131	HW151
Vermogen		1800 W	1800 W	2200 W	2500 W
Max. druk		120 bar	130 bar	130 bar	150 bar
Max. debiet		420 l/u	420 l/u	500 l/u	500 l/u
Haspel		10 m	10 m	15 m	10 m
Gewicht		11,0 kg	12,7 kg	33 kg	26,9 kg
Prijs in €	excl. btw	€ 304,96	€ 387,60	€ 486,78	€ 619,01
	incl. btw	€ 369,00	€ 469,00	€ 589,00	€ 749,00

UM600D / DUM111 / DUM604

ACCU GRAS- EN HEGGENSCHAAR

PROMO

Gratis opbergtas bij UM600DSAEX, DUM111SYX en DUM604RFEX



DUM604RFEX



DUM111SYX

	UM600DSAEX	DUM111SYX	DUM604RFEX	DUM604ZX	
Spanning	10,8V (12Vmax)	18V	18V	18V	
Bijgeleverde accu's	2 x accu 2,0 Ah	1 x accu 1,5 Ah	2 x accu 3,0 Ah	-	
Lader	DC10SB	DC18SD	DC18RC	-	
Snijlengte heggenschaar	20 cm	20 cm	20 cm	20 cm	
Snijbreedte grasschaar	16 cm	11 cm	16 cm	16 cm	
Maximale takdikte	8 mm	-	10 mm	10 mm	
Geleverd met	Grasschaar + Heggenschaar	Grasschaar + Heggenschaar	Grasschaar + Heggenschaar	Grasschaar + Heggenschaar	
Gewicht	1,2 kg	1,8 kg	1,8 kg	1,8 kg	
Prijs in €	excl. btw	€ 202,48	€ 161,16	€ 268,60	€ 86,78
	incl. btw	€ 245,00	€ 195,00	€ 325,00	€ 105,00

DUH507 / DUH607 / DUH551

ACCU HEGGENSCHAREN



DUH607Z

DUH551Z



DUH507 & DUH607:

- Budgetvriendelijke versies
- Compact en uiterst licht
- Versterkt krukasmechanisme
- Handgreep met nieuw ontworpen schakelaar
- Hoogwaardige trillingsdemping

	DUH507Z	DUH507F001	DUH607Z	DUH607F001	DUH551Z	
Spanning	18V	18V	18V	18V	2 x 18V	
Bijgeleverde accu's	-	1x accu 3,0 Ah	-	1x accu 3,0 Ah	-	
Bijgeleverde lader	-	DC18WC	-	DC18WC	-	
BL motor	-	-	-	-	-	
Snijlengte	50 cm	50 cm	60 cm	60 cm	55 cm	
Maximale takdikte	15 mm	15 mm	15 mm	15 mm	18 mm	
Aantal snijbewegingen	2700 min ⁻¹	2700 min ⁻¹	2700 min ⁻¹	2700 min ⁻¹	2000-3600 min ⁻¹	
Max. uitgangsvermogen	250 W	250 W	250 W	250 W	320 W	
Gewicht	2,7 - 3,0 kg	2,7 - 3,0 kg	2,8 - 3,1 kg	2,8 - 3,1 kg	4,1 kg	
Prijs in €	excl. btw	€ 147,93	€ 214,05	€ 152,89	€ 222,31	€ 263,64
	incl. btw	€ 179,00	€ 259,00	€ 185,00	€ 269,00	€ 319,00

DUH506 / DUH606

ACCU HEGGENSCHAREN 18V



DUH606RF

DUH506 & DUH606:

- Zeer efficiënt dankzij BL motor
- Compact en uiterst licht
- Versterkt krukasmechanisme
- Handgreep met nieuw ontworpen schakelaar
- Hoogwaardige trillingsdemping

	DUH506Z	DUH506RF	DUH606Z	DUH606RF	
Spanning	18V	18V	18V	18V	
Bijgeleverde accu's	-	1x accu 3,0 Ah	-	1x accu 3,0 Ah	
Bijgeleverde lader	-	DC18RC	-	DC18RC	
BL motor	✓	✓	✓	✓	
Snijlengte	50 cm	50 cm	60 cm	60 cm	
Max. takdikte	20 mm	20 mm	20 mm	20 mm	
Aantal snijbewegingen	4000 min ⁻¹	4000 min ⁻¹	4000 min ⁻¹	4000 min ⁻¹	
Max. uitgangsvermogen	320 W	320 W	320 W	320 W	
Gewicht	2,5 - 2,9 kg	2,5 - 2,9 kg	2,7 - 3,0 kg	2,7 - 3,0 kg	
Prijs in €	excl. btw	€ 180,99	€ 288,43	€ 185,95	€ 296,69
	incl. btw	€ 219,00	€ 349,00	€ 225,00	€ 359,00

DUH502 / DUH602 / DUH752

ACCU HEGGENSCHAREN 18 V



TANDEN MET KLASIEKE GEOMETRIE



DUH502RT

		DUH502Z	DUH502RT	DUH602Z	DUH602RT	DUH752Z	DUH752RT
Spanning		18V	18V	18V	18V	18V	18V
Bijgeleverde accu's		-	1 x accu 5,0 Ah	-	1 x accu 5,0 Ah	-	1 x accu 5,0 Ah
Bijgeleverde lader		-	1 x DC18RC	-	1 x DC18RC	-	1 x DC18RC
BL motor		✓	✓	✓	✓	✓	✓
Snijlengte		50 cm	50 cm	60 cm	60 cm	75 cm	75 cm
Max. takdikte		21,5 mm	21,5 mm	21,5 mm	21,5 mm	21,5 mm	21,5 mm
Aantal snijbewegingen		2000 / 3600 / 4400 min ⁻¹	2000 / 3600 / 4400 min ⁻¹	2000 / 3600 / 4400 min ⁻¹	2000 / 3600 / 4400 min ⁻¹	2000 / 3600 / 4400 min ⁻¹	2000 / 3600 / 4400 min ⁻¹
Max. uitgangsvermogen		520 W	520 W	520 W	520 W	520 W	520 W
Gewicht		3,8 kg	3,8 kg	3,8 kg	3,8 kg	3,8 kg	3,8 kg
Prijs in €	excl. btw	€ 313,22	€ 412,40	€ 321,49	€ 445,45	€ 346,28	€ 478,51
	incl. btw	€ 379,00	€ 499,00	€ 389,00	€ 539,00	€ 419,00	€ 579,00

DUH501 / DUH601 / DUH751 / DUH754S

ACCU HEGGENSCHAREN 18 V

PROMO

gratis DMR057 na online registratie DUH501RTE



TANDEN MET INNOVATIEVE GEOMETRIE

DUH501RTE



DUH754SZ
(ENKELZIJDIG MES)

INNOVATIEVE GEOMETRIE

Beter snijresultaat
Minder wrijving
Grotere batterijautonomie

		DUH501Z	DUH501RTE	DUH601Z	DUH601PTE	DUH751Z	DUH751PTE	DUH754SZ
Uitvoering		Trim	Trim	Trim	Trim	Trim	Trim	Trim
Mes		Dubbelzijdig	Dubbelzijdig	Dubbelzijdig	Dubbelzijdig	Dubbelzijdig	Dubbelzijdig	Enkelzijdig
Bijgeleverde accu's		-	2 x accu 5,0 Ah	-	2 x accu 5,0 Ah	--	2 x accu 5,0 Ah	-
Bijgeleverde Lader		-	1 x DC18RC	-	1 x DC18RD	-	1 x DC18RD	-
BL motor		✓	✓	✓	✓	✓	✓	✓
Aantal snijbewegingen		2000/3600/4400 min ⁻¹	2000/3600/4400 min ⁻¹	2000/3600/4400 min ⁻¹	2000/3600/4400 min ⁻¹	2000/3600/4400 min ⁻¹	2000/3600/4400 min ⁻¹	2000/3600/4400 min ⁻¹
Snijlengte		50 cm	50 cm	60 cm	60 cm	75 cm	75 cm	75 cm
Max. takdikte		23,5 mm	23,5 mm	23,5 mm	23,5 mm	23,5 mm	23,5 mm	23,5 mm
Max. uitgangsvermogen		520 W	520 W	520 W	520 W	520 W	520 W	520 W
Gewicht		3,8 - 4,5 kg	3,8 - 4,5 kg	3,8 - 4,5 kg	3,8 - 4,5 kg	3,8 - 4,5 kg	3,8 - 4,5 kg	3,4 - 3,9 kg
Prijs in €	excl. btw	€ 326,45	€ 541,32	€ 338,02	€ 610,74	€ 362,81	€ 619,01	€ 511,57
	incl. btw	€ 395,00	€ 655,00	€ 409,00	€ 739,00	€ 439,00	€ 749,00	€ 619,00

UH004G / UH005G

ACCU HEGGENSCHAREN 40VMAX 'TRIMVERSIE'



PROMO

gratis AS001GZ na online registratie UH004GM201 & UH005GM201



UH004GM201

		UH004GZ	UH004GM201	UH005GZ	UH005GM201
Uitvoering		Trim	Trim	Trim	Trim
Mes		Dubbelzijdig	Dubbelzijdig	Dubbelzijdig	Dubbelzijdig
Bijgeleverde accu's		-	2x BL4040	-	2x BL4040
Bijgeleverde lader		-	DC40RA	-	DC40RA
Aantal snijbewegingen		2000/3600/ 5000 min ⁻¹	2000/3600/ 5000 min ⁻¹	2000/3600/ 5000 min ⁻¹	2000/3600/ 5000 min ⁻¹
Snijlengte		60 cm	60 cm	75 cm	75 cm
Max. takdikte		23,5 mm	23,5 mm	23,5 mm	23,5 mm
Max. uitgangsvermogen		720 W	720 W	720 W	720 W
Gewicht		4,3 - 4,9 kg	4,3 - 4,9 kg	4,5 - 5,1 kg	4,5 - 5,1 kg
Prijs in €	excl. btw	€ 453,72	€ 891,74	€ 478,51	€ 908,26
	incl. btw	€ 549,00	€ 1.079,00	€ 579,00	€ 1.099,00

UH006G / UH007G

ACCU HEGGENSCHAREN 40VMAX 'TERUGSNOEIVERSIE'



PROMO

gratis AS001GZ na online registratie UH006GM201 & UH007GM201



UH006GM201

		UH006GZ	UH006GM201	UH007GZ	UH007GM201
Uitvoering		Terugsnoei	Terugsnoei	Terugsnoei	Terugsnoei
Mes		Dubbelzijdig	Dubbelzijdig	Dubbelzijdig	Dubbelzijdig
Bijgeleverde accu's		-	2x BL4040	-	2x BL4040
Bijgeleverde lader		-	DC40RA	-	DC40RA
Aantal snijbewegingen		2000/3000/ 4000 min ⁻¹	2000/3000/ 4000 min ⁻¹	2000/3000/ 4000 min ⁻¹	2000/3000/ 4000 min ⁻¹
Snijlengte		60 cm	60 cm	75 cm	75 cm
Max. takdikte		25 mm	25 mm	25 mm	25 mm
Max. uitgangsvermogen		720 W	720 W	720 W	720 W
Gewicht		4,4 - 5,0 kg	4,4 - 5,0 kg	4,6 - 5,2 kg	4,6 - 5,2 kg
Prijs in €	excl. btw	€ 453,72	€ 891,74	€ 478,51	€ 908,26
	incl. btw	€ 549,00	€ 1.079,00	€ 579,00	€ 1.099,00

UN460W / DUN461 / DUN500

ACCU STOKHEGGENSCHAREN (CXT/LXT)



DUN461WST

DUN500WZ

DUN500WZ (520 W)

- Instelbaar in 6 hoeken
- Dubbele greep voor extra comfort
- Innovatieve tandengeometrie
- Totale lengte: 2,1 m

DUN461

- Klassieke tandengeometrie
- Telescopische steel 1,9 m en 2,5 m

		UN460WDZ	UN460WDWA	DUN461WZ	DUN461WST	DUN500WZ
Accuplatform		12Vmax (CXT)	12Vmax (CXT)	18 V (LXT)	18 V (LXT)	18 V (LXT)
Bijgeleverde accu's		-	1 x accu 2,0 Ah	-	1 x accu 5,0 Ah	-
Bijgeleverde lader		-	DC10WD	-	DC18SD	-
Snijlengte		46 cm	46 cm	46 cm	46 cm	50 cm
Maximale takdikte		18 mm	18 mm	18 mm	18 mm	23,5 mm
Totale lengte		1,889 - 2,511 mm	1,889 - 2,511 mm	1,889 - 2,511 mm	1,889 - 2,511 mm	2,115 mm
BL motor		-	-	-	-	✓
Aantal snijbewegingen		3600 min ⁻¹	3600 min ⁻¹	3600 min ⁻¹	3600 min ⁻¹	2000/3600/ 4400 min ⁻¹
Omkeerfunctie		✓	✓	✓	✓	✓
Gewicht		2,8 - 3,0 kg	2,8 - 3,0 kg	3,0 - 3,3 kg	3,4 kg	3,9 - 4,3 kg
Prijs in €	excl. btw	€ 156,20	€ 247,11	€ 164,46	€ 304,96	€ 395,87
	incl. btw	€ 189,00	€ 299,00	€ 199,00	€ 369,00	€ 479,00

DUB187

ACCU BLADBLAZER / - ZUIGER 18 V



DUB187T001

		DUB187Z	DUB187T001
Spanning		18V	18V
Bijgeleverde accu's		-	BL1850B
Bijgeleverde lader		-	DC18WC
Luchtsnelheid (blazen)		64 m/s	64 m/s
Max. debiet (zuigen)		6,1 m³/min	6,1 m³/min
Max. onderdruk		33 mbar	33 mbar
Max. blaaskracht		4,2 N	4,2 N
Gewicht		3,7 - 4,0 kg	3,7 - 4,0 kg
Prijs in €	excl. btw	€ 194,21	€ 285,12
	incl. btw	€ 235,00	€ 345,00

DUB184

ACCU BLADBLAZER 18 V



DUB184Z

		DUB184Z	DUB184RT
Spanning		18V	18V
Bijgeleverde accu's		-	1 x BL1850B
Bijgeleverde lader		-	DC18RC
Luchtsnelheid		49 m/s	49 m/s
Max. debiet		12,7 m³/min	12,7 m³/min
Max. blaaskracht		10,9 N	10,9 N
Gewicht		2,5 - 3,0 kg	2,5 - 3,0 kg
Prijs in €	excl. btw	€ 144,63	€ 263,64
	incl. btw	€ 175,00	€ 319,00

DUB362

ACCU BLADBLAZER 2 x 18 V



DUB362Z

		DUB362Z	DUB362TX1
Spanning		2x18V	2x18V
Bijgeleverde accu's		-	4 x BL1850B
Bijgeleverde lader		-	DC18RD
Luchtsnelheid		54 m/s	54 m/s
Max. debiet		13,4 m³/min	13,4 m³/min
Max. blaaskracht		14,4 N	14,4 N
Gewicht		3,5 - 4,2 kg	3,5 - 4,2 kg
Prijs in €	excl. btw	€ 255,37	€ 693,39
	incl. btw	€ 309,00	€ 839,00

UB001G

ACCU BLADBLAZER 40VMAX



PROMO

gratis AS001GZ na online registratie UB001GM101



STANDAARD GELEVERD MET PLATTE & RONDE BLAASMOND

		UB001GZ	UB001GM101
Spanning		36V (40Vmax)	36V (40Vmax)
Bijgeleverde accu's		-	1x BL4040
Bijgeleverde lader		-	DC40RA
Luchtsnelheid		64 m/s	64 m/s
Max. debiet		16,0 m³/min	16,0 m³/min
Max. blaaskracht		12 N (17 N boost)	12 N (17 N boost)
Gewicht		3,1 - 3,9 kg	3,1 - 3,9 kg
Prijs in €	excl. btw	€ 280,17	€ 544,63
	incl. btw	€ 339,00	€ 659,00

DUB363

ACCU BLADBLAZER / -ZUIGER 2 x 18 V



Geleverd met bladzuigset

DUB363ZV

Spanning		2 x 18V
Bijgeleverde accu's		-
Bijgeleverde lader		-
Luchtsnelheid		54 m/s
Max. debiet		13,4 m³/min
Max. blaaskracht		14,4 N
Gewicht		4,5 - 6,6 kg
Prijs in €	excl. btw	€ 326,45
	incl. btw	€ 395,00

UB001C / UB003C

BLADBLAZER MET RECHTSTREEKSE AANSLUITING OP ACCUPACK



UB001CZ

UB003CZ

UB003C

- Voor gebruik in combinatie met PDC01, PDC1200 of PDC1500 (directe aansluiting)
- Levert het hoogste blaasvermogen (24 N) in combinatie met PDC1500
- Hoge luchtstroom door een verbeterde vorm van de vaste bladen in de turbine
- Laag gewicht

NIEUW

	UB001CZ	UB003CZ
Platform	PDC01/PDC1200/ PDC1500	PDC01/PDC1200/ PDC1500
Max. luchtsnelheid	60 m/s (70 m/s boost)	86 m/s
Max. debiet	15 m ³ /min (17,6 m ³ /min boost)	17,6 m ³ /min
Max. blaaskracht	15 N (20 N boost)	24 N
Autonomie	60 min (20 N, PDC1200)	60 min (24 N, PDC1500)
Gewicht	2,6 kg	2,8 - 3,1 kg
Prijs in €	excl. btw	€ 395,87
	incl. btw	€ 479,00



PDC01



PDC1200



PDC1500

PDC1500

- Hoge energiecapaciteit van 1567,8 Wh
- Zeer comfortabel nieuw ontworpen harnas
- Kan een hoger vermogen leveren in combinatie met de nieuwste machines zoals UB003C
- Compatibel met 2x 18V en 40V(max) (middels adapter) en 36V machines met directe aansluiting
- Kan ook los van het harnas gebruikt worden
- WetGuard/IPX4 compatibel

PDC01

	191A64-2	191A59-5	191C50-5
Bestelreferentie	191A64-2	191A59-5	191C50-5
Accu	1 tot 4 LXT accu's	1 tot 4 LXT accu's	1 tot 4 LXT accu's
Energiecapaciteit	Max. 432 Wh	Max. 432 Wh	Max. 432 Wh
Meegeleverde adapters	18V (191J51-5)	18V (191J50-7) 2x18V (191J51-5)	18V (191J50-7) 2x18V (191J51-5)
Bijgeleverde accu's	-	-	4 x 5,0 Ah
Bijgeleverde lader	-	-	DC18RD
Netto gewicht	4,0 kg	4,0 kg	4,0 kg
Gewicht incl. accu en harnas	7,0 kg	7,0 kg	7,0 kg
Prijs in €	excl. btw	439,00	495,00
	incl. btw	531,19	598,95

PDC1200

PDC1500

	PDC1200	PDC1500
Bestelreferentie	BEAPDC1200A01	EUAPDC1500A01
Accu	Geïntegreerd	Geïntegreerd
Energiecapaciteit	1206 Wh	1567,8 Wh
Bijgeleverde lader	DC4001	DC4001
Laadtijd	6 uur	8 uur
Meegeleverde adapters	2x18V (191J51-5)	-
Gewicht incl. harnas	8,8 kg	13,9 kg
Prijs in €	excl. btw	1299,00
	incl. btw	1571,79

UB002CZ

RUGGEDRAGEN BLADBLAZER MET RECHTSTREEKSE AANSLUITING OP ACCUPACK



ACCU NIET INBEGREPEN!

UB002CZ

Platform	Accupack PDC1200	
Luchtsnelheid	71,7 m/s	
Max. debiet	19 m ³ /min	
Max. blaaskracht	22 N	
Geluidsdruk niveau	81 dB (A)	
Autonomie	45 min (22 N, PDC1200)	
Gewicht	15,9 - 16,1 kg	
Prijs in €	excl. btw	€ 607,44
	incl. btw	€ 735,00



Het accupack kan in één beweging op de machine vastgeklippt worden.



Triggerschakelaar met variabele snelheid en "cruise control" hendel.



De bedieningshendel kan horizontaal verschoven en gekanteld worden.

UC100D / DUC101

ACCU SNOEIZAGEN



DUC101SF

		UC100DZ	DUC101Z	DUC101SF	DUC150Z
Spanning		10,8V (12Vmax)	18V	18V	18V
Bijgeleverde accu's		-	-	1x accu 3,0 Ah	-
Bijgeleverde lader		-	-	DC18SD	-
BL motor		✓	✓	✓	✓
Snelspansysteem		✓	✓	✓	✓
Zwaardlengte		100 mm	100 mm	100 mm	150 mm
Ketting		80 TXL (0,325, 1,1 mm)	80 TXL (0,325, 1,1 mm)	80 TXL (0,325, 1,1 mm)	80 TXL (0,325, 1,1 mm)
Kettingsnelheid		8 m/s	8 m/s	8 m/s	8 m/s
Gewicht		1,5-1,6 kg	1,6-2,0 kg	1,6-2,0 kg	1,7-2,0 kg
Prijs in €	excl. btw	€ 152,89	€ 189,26	€ 304,96	€ 197,52
	incl. btw	€ 185,00	€ 229,00	€ 369,00	€ 239,00

DUA301

ACCU HOOGSNOEIER 2 x 18 V

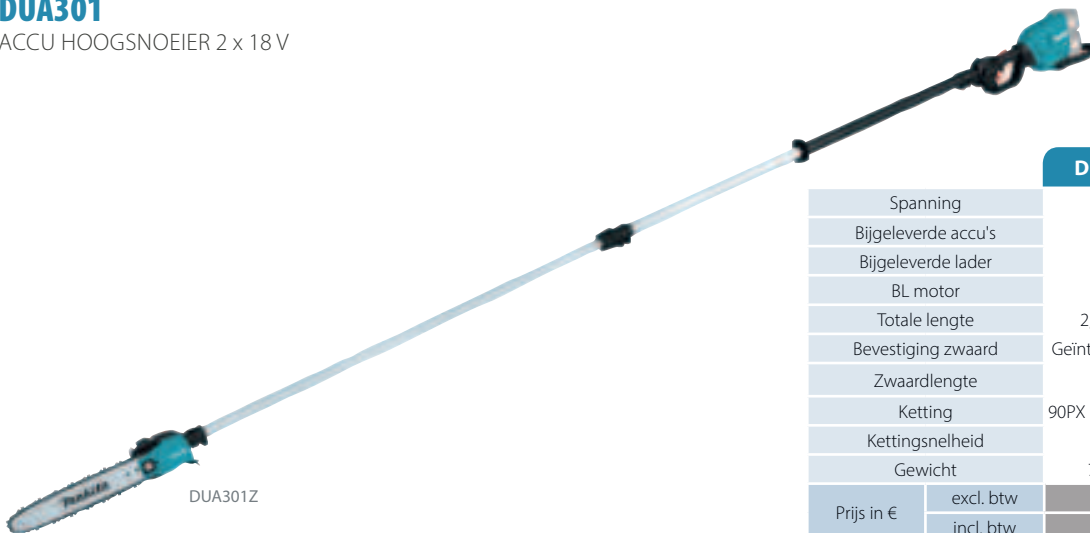

DUA301Z

		DUA301Z	DUA301PT2
Spanning		2x 18V	2x 18V
Bijgeleverde accu's		0	2x 5,0 Ah
Bijgeleverde lader		-	DC18RD
BL motor		✓	✓
Totale lengte		2,53 - 3,76 m	2,53 - 3,76 m
Bevestiging zwaard		Geïntegreerde moer	Geïntegreerde moer
Zwaardlengte		30 cm	30 cm
Ketting		90PX (0,325", 1,1 mm)	90PX (0,325", 1,1 mm)
Kettingsnelheid		0 - 20 m/s	0 - 20 m/s
Gewicht		7,8 - 8,5 kg	7,8 - 8,5 kg
Prijs in €	excl. btw	€ 602,48	€ 858,68
	incl. btw	€ 729,00	€ 1.039,00

UA004G

ACCU HOOGSNOEIER 40VMAX



UA004GZ

		UA004GZ	UA004GM101
Spanning		36V (40Vmax)	36V (40Vmax)
Bijgeleverde accu's		-	1x 4,0 Ah
Bijgeleverde Lader		-	DC40RA
BL motor		✓	✓
Totale lengte		2,53 - 3,76 m	2,53 - 3,76 m
Bevestiging zwaard		Geïntegreerde moer	Geïntegreerde moer
Zwaardlengte		30 cm	30 cm
Ketting		90PX (0,325", 1,1 mm)	90PX (0,325", 1,1 mm)
Kettingsnelheid		0 - 20 m/s	0 - 20 m/s
Gewicht		7,8 - 9,1 kg	7,8 - 9,1 kg
Prijs in €	excl. btw	€ 602,48	€ 866,94
	incl. btw	€ 729,00	€ 1.049,00

DUC122 / DUC254

ACCU SNOEIKETTINGZAGEN 18V



DUC122RTE

DUC254Z001

OPGELET: voor het gebruik van een tophandle kettingzaag is een opleiding vereist. Raadpleeg steeds de veiligheidsvoorschriften.

		DUC122ZK	DUC122RTE	DUC254Z001
Spanning		18V	18V	18V
Bijgeleverde accu's		-	1 x accu 5,0 Ah	-
Bijgeleverde lader		-	DC18RC	-
BL motor		-	-	✓
Spansysteem		Snelspansysteem	Snelspansysteem	Geïntegreerde moeren
Zwaardlengte		11,5 cm	11,5 cm	25 cm
Ketting		025 (1/4", 1,3 mm)	025 (1/4", 1,3 mm)	80PX (0,325", 1,1 mm)
Kettingsnelheid		5 m/s	5 m/s	24 m/s
Gewicht		2,6 kg	2,6 kg	2,8 - 3,2 kg
Prijs in €	excl. btw	€ 202,48	€ 409,09	€ 271,90
	incl. btw	€ 245,00	€ 495,00	€ 329,00

DUC256 / -306 / -356 / -406

ACCU SNOEIKETTINGZAGEN 2 x 18V

PROMO

gratis 87-delige gereedschapset E-08458



DUC256Z001

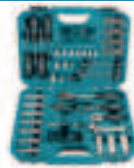

		DUC256Z001	DUC306Z001	DUC356Z001	DUC406Z001
Spanning		2x 18V	2x 18V	2x 18V	2x 18V
Bijgeleverde accu's		-	-	-	-
Bijgeleverde lader		-	-	-	-
BL motor		✓	✓	✓	✓
Snelspansysteem		-	-	-	-
Geïntegreerde moeren		✓	✓	✓	✓
Zwaardlengte		25 cm	30 cm	35 cm	40 cm
Ketting		80 TXL (0,325, 1,1 mm)	80 TXL (0,325, 1,1 mm)	80 TXL (0,325, 1,1 mm)	80 TXL (0,325, 1,1 mm)
Kettingsnelheid		20 m/s	20 m/s	20 m/s	20 m/s
Gewicht		4,6-5,1 kg	4,6-5,1 kg	4,6-5,1 kg	4,6-5,1 kg
Prijs in €	excl. btw	€ 400,83	€ 404,13	€ 409,09	€ 412,40
	incl. btw	€ 485,00	€ 489,00	€ 495,00	€ 499,00

UC002G / UC003G / UC004G / UC006G

ACCU SNOEIKETTINGZAGEN 40VMAX

PROMO

Gratis AS001GZ na online registratie UC002GM101, UC003GM101, UC004GM101



UC006GZ

UC003GM101

		UC002GZ	UC002GM101	UC003GZ	UC003GM101	UC004GZ	UC004GM101	UC006GZ
Spanning		36V (40Vmax)	36V (40Vmax)	36V (40Vmax)	36V (40Vmax)	36V (40Vmax)	36V (40Vmax)	36V (40Vmax)
Bijgeleverde accu's		-	1x 4,0 Ah	-	1x 4,0 Ah	-	1x 4,0 Ah	-
Bijgeleverde lader		-	DC40RA	-	DC40RA	-	DC40RA	-
BL motor		✓	✓	✓	✓	✓	✓	✓
Geïntegreerde moeren		✓	✓	✓	✓	✓	✓	✓
Zwaardlengte		25 cm	25 cm	30 cm	30 cm	35 cm	35 cm	25 cm Carving
Ketting		90PX (3/8", 1,1 mm)	90PX (3/8", 1,1 mm)	90PX (3/8", 1,1 mm)	90PX (3/8", 1,1 mm)	90PX (3/8", 1,1 mm)	90PX (3/8", 1,1 mm)	90PX (1/4", 1,3 mm)
Kettingsnelheid		0 - 24,8 m/s	0 - 24,8 m/s	0 - 24,8 m/s	0 - 24,8 m/s	0 - 24,8 m/s	0 - 24,8 m/s	0 - 24,8 m/s
Gewicht		3,8 - 4,7 kg	3,8 - 4,7 kg	3,8 - 4,7 kg	3,8 - 4,7 kg	3,8 - 4,7 kg	3,8 - 4,7 kg	3,8 - 4,7 kg
Prijs in €	excl. btw	€ 400,83	€ 681,82	€ 404,13	€ 685,12	€ 409,09	€ 690,08	€ 428,93
	incl. btw	€ 485,00	€ 825,00	€ 489,00	€ 829,00	€ 495,00	€ 835,00	€ 519,01

DUC307 / DUC357

ACCU KETTINGZAGEN 18V



DUC357RTX2

	DUC307ZX2	DUC307RTX2	DUC357ZX2	DUC357RTX2	
Spanning	18V	18V	18V	18V	
Bijgeleverde accu's	-	1x 5,0 Ah	-	1x 5,0 Ah	
Bijgeleverde lader	-	DC18RC	-	DC18RC	
BL motor	✓	✓	✓	✓	
Snelspansysteem	✓	✓	✓	✓	
Zwaardlengte	30 cm	30 cm	35 cm	35 cm	
Ketting	90PX (3/8", 1,1 mm)	90PX (3/8", 1,1 mm)	90PX (3/8", 1,1 mm)	90PX (3/8", 1,1 mm)	
Kettingsnelheid	7,7 m/s	7,7 m/s	7,7 m/s	7,7 m/s	
Gewicht	4,2 - 4,4 kg	4,2 - 4,4 kg	4,2 - 4,4 kg	4,2 - 4,4 kg	
Prijs in €	excl. btw	€ 247,11	€ 346,28	€ 252,07	€ 351,24
	incl. btw	€ 299,00	€ 419,00	€ 305,00	€ 425,00

DUC353 / DUC405

ACCU KETTINGZAGEN 2 x 18V



DUC405Z

PROMO

GRATIS ACCU 5,0 Ah na online registratie

	DUC353Z	DUC405Z	
Spanning	2x 18V	2x 18V	
Bijgeleverde accu's	-	-	
Bijgeleverde lader	-	-	
BL motor	✓	✓	
Zwaardlengte	35 cm	40 cm	
Bevestiging zwaard	Snelspansysteem	Geïntegreerde moeren	
Ketting	90PX (3/8", 1,1 mm)	90PX (3/8", 1,1 mm)	
Kettingsnelheid	20 m/s	20 m/s	
Gewicht	4,6 - 5,5 kg	4,6 - 5,5 kg	
Prijs in €	excl. btw	€ 351,24	€ 376,03
	incl. btw	€ 425,00	€ 455,00

UC010G / UC011G / UC012G / UC013G

ACCU KETTINGZAAAG 40Vmax



UC012GT102

UC013GT102

PROMO

gratis AS001GZ na online registratie UC010GT101, UC011GT101, UC012GT102 & UC013GT102



HOOG VERMOGEN
HOGE KETTINGSNELHEID
REGEELBAAR OLIEDEBIET
LAAG TRILLINGSNIVEAU

	UC010GZ	UC010GT101	UC011GZ	UC011GT101	UC012GZ01	UC012GT102	UC013GZ01	UC013GT102	
Spanning	36V (40Vmax)	36V (40Vmax)	36V (40Vmax)	36V (40Vmax)	36V (40Vmax)	36V (40Vmax)	36V (40Vmax)	36V (40Vmax)	
Bijgeleverde accu's	-	1 x 5,0 Ah	-	1 x 5,0 Ah	-	1 x 5,0 Ah	-	1 x 5,0 Ah	
Bijgeleverde lader	-	DC40RA	-	DC40RA	-	DC40RA	-	DC40RA	
BL motor	✓	✓	✓	✓	✓	✓	✓	✓	
Geïntegreerde moeren	✓	✓	✓	✓	✓	✓	✓	✓	
Zwaardlengte	30 cm	30 cm	35 cm	35 cm	40 cm	40 cm	45 cm	45 cm	
Ketting	80TXL (0,325, 1,1 mm)	80TXL (0,325, 1,1 mm)	80TXL (0,325, 1,1 mm)	80TXL (0,325, 1,1 mm)	3/8" 1,3 mm	3/8" 1,3 mm	3/8" 1,3 mm	3/8" 1,3 mm	
Kettingsnelheid	0 - 25,5 m/s	0 - 25,5 m/s	0 - 25,5 m/s	0 - 25,5 m/s	0 - 25,5 m/s	0 - 25,5 m/s	0 - 25,5 m/s	0 - 25,5 m/s	
Gewicht	6,1 - 7,4 kg	6,1 - 7,4 kg	6,1 - 7,4 kg	6,1 - 7,4 kg	6,1 - 7,4 kg	6,1 - 7,4 kg	6,1 - 7,4 kg	6,1 - 7,4 kg	
Prijs in €	excl. btw	€ 561,16	€ 855,37	€ 566,12	€ 875,21	€ 569,42	€ 880,17	€ 574,38	€ 883,47
	incl. btw	€ 679,00	€ 1.035,00	€ 685,00	€ 1.059,00	€ 689,00	€ 1.065,00	€ 695,00	€ 1.069,00

DUX18

ACCU COMBISYSTEEM 18 V



DUX18Z

		DUX18Z	DUX18ZX1
Platform		LXT 18 V	LXT 18 V
Max. afgegeven vermogen		470 W	470 W
Toerental onbelast		0 - 6800 / 0 - 9700 min ⁻¹	0 - 6800 / 0 - 9700 min ⁻¹
Bijgeleverde accessoires		-	EM408MP
Bijgeleverde accu's / laders		-	-
Prijs in €	excl. btw	€ 205,79	€ 271,90
	incl. btw	€ 249,00	€ 329,00

DUX60

ACCU COMBISYSTEEM
2 x 18 V



DUX60Z

		DUX60Z	DUX60ZN1	DUX60ZM4	DUX60ZX8
Platform		LXT 2 x 18 V	LXT 2 x 18 V	LXT 2 x 18 V	LXT 2 x 18 V
Max. afgegeven vermogen		600 W	600 W	600 W	600 W
Toerental onbelast		0 - 5700 / 0 - 8200 / 0 - 9700 min ⁻¹	0 - 5700 / 0 - 8200 / 0 - 9700 min ⁻¹	0 - 5700 / 0 - 8200 / 0 - 9700 min ⁻¹	0 - 5700 / 0 - 8200 / 0 - 9700 min ⁻¹
Bijgeleverde accessoires		-	EN401MP	EM404MP	EN401MP EM404MP
Bijgeleverde accu's / laders		-	-	-	-
Prijs in €	excl. btw	€ 280,17	€ 466,94	€ 395,87	€ 594,21
	incl. btw	€ 339,00	€ 565,00	€ 479,00	€ 719,00

COMBISYSTEEM OPZETSTUKKEN

Artikel	Referentie	Ø (mm)	Prijs excl. btw	Prijs incl. btw
BOSMAAIER (Voor DUX18 enkel EM408MP geschikt)				
EM404MP	198768-1	450 mm	€ 105,00	€ 127,05
EM401MP	195888-2	300 mm	€ 105,04	€ 127,10
EM400MP	195648-2	420 mm	€ 94,46	€ 114,30
EM406MP	198779-6	420 mm	€ 99,00	€ 119,79
EM408MP	191N31-5	300 mm	€ 99,01	€ 119,80
ROTORSCHAAR				
EM407MP	191M56-3		€ 396,28	€ 479,50
GRASTRIMMER				
ER400MP	195522-4	410 mm	€ 87,60	€ 106,00
SNOEIKETTINGZAAG				
EY403MP	191T38-7		€ 264,21	€ 319,69
STOKHEGGENSCHAAR				
EN401MP	196256-2		€ 245,70	€ 297,30
EN410MP	197726-4		€ 198,68	€ 240,40
EN402MP	1912T8-8		€ 199,01	€ 240,80
EN422MP	1912T0-4		€ 189,00	€ 228,69
GRONDFREES				
KR400MP	199181-6		€ 249,00	€ 301,29
BOORDENSNIJDER				
EE400MP	196752-0		€ 123,14	€ 149,00
VERLENGSTUK				
LE400MP	191E24-8		€ 87,60	€ 106,00
ROLVEGER				
SW400MP	199339-7		€ 359,00	€ 434,39
ROLBORSTEL				
BR400MP	199318-5		€ 349,00	€ 422,29
BLAZER				
UB401MP	191P72-3		€ 143,47	€ 173,60
UB402MP	1912R8-4		€ 92,48	€ 111,90
WATERPOMP				
PF400MP	DEAPF400MP		€ 199,01	€ 240,80
SCHOFFEL				
NIEUW WA400MP	1913P8-6		€ 346,28	€ 419,00
MAAIBALK				
EN424MP	1913C9-3		€ 227,50	€ 275,28

UX01GZ

ACCU COMBISYSTEEM 40VMAX

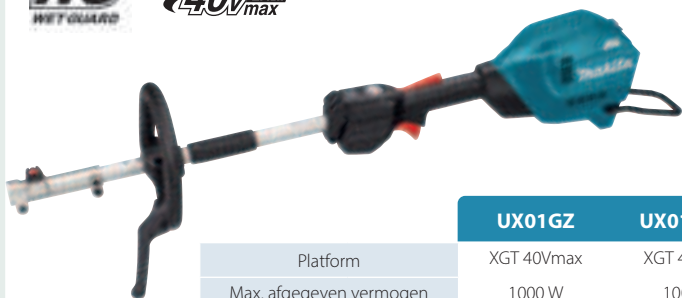

		UX01GZ	UX01GZ01
Platform		XGT 40Vmax	XGT 40Vmax
Max. afgegeven vermogen		1000 W	1000 W
Toerental onbelast		0 - 5700 / 0 - 8200 / 0 - 9700 min ⁻¹	0 - 5700 / 0 - 8200 / 0 - 9700 min ⁻¹
Bijgeleverde accessoires		-	EM404MP
Bijgeleverde accu's / laders		-	-
Prijs in €	excl. btw	€ 280,17	€ 395,87
	incl. btw	€ 339,00	€ 479,00

DDG460 / DDG461
 ACCU GRONDBOOR 2 x 18 V

LXT ADT BL MOTOR XPT

18V+18V → 36V



DDG460Zx7



DDG461Z

DDG460 is uitgerust met boorkop; voor het aansluiten van een grondboor is een adapter nodig (Type "D" voor Makita grondboren, Type "A" voor Stihl grondboren). De DDG461 daarentegen heeft een as-gat opname waar de Makita grondboren rechtstreeks op passen.



	DDG460Zx7	DDG460T2x7	DDG461Z
Spanning	2 x 18 V	2 x 18 V	36 V (40Vmax)
Bijgeleverde accu's	-	2x BL1850B	-
Bijgeleverde lader	-	DC18RD	-
Max. diameter boor	200 mm	200 mm	200 mm
Opname	Boorkop	Boorkop	Directe aansluiting
Max. koppel	136 Nm	136 Nm	136 Nm
Toerental onbelast	0 - 350 min ⁻¹ 0 - 1400 min ⁻¹	0 - 350 min ⁻¹ 0 - 1400 min ⁻¹	0 - 350 min ⁻¹ 0 - 1400 min ⁻¹
Gewicht	7,3 - 8,2 kg	7,3 - 8,2 kg	7,0 - 7,6 kg
Prijs in €	excl. btw	€ 627,27	€ 908,26
	incl. btw	€ 759,00	€ 1.099,00
		€ 544,63	€ 659,00



Omkeerschakelaar

De draairichting kan omgekeerd worden om de boor los te maken wanneer ze geblokkeerd geraakt is of te diep vastzit in zware kleigrond.



Slijpkoppeling

De slijpkoppeling verbreekt de verbinding tussen de motor en de boor wanneer het koppel een extreme waarde overschrijdt. Dat voorkomt schade aan de machine en verhoogt de veiligheid voor de gebruiker.

Scan hier voor het overzicht grondboren



DG001G / DG002G
 ACCU GRONDBOOR 40VMAX

WG ADT BL MOTOR XPT XGT 40Vmax

PROMO

gratis AS001GZ na online registratie DG001GM105

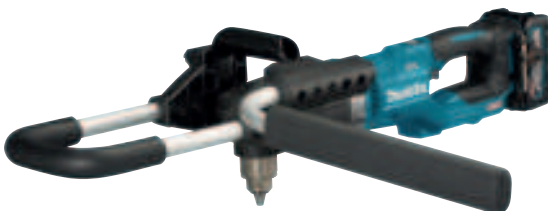

DG001GM105



DG002GZ



DG001G is uitgerust met boorkop. Voor het aansluiten van een grondboor is een adapter nodig. (Type D voor Makita grondboren, type A voor Stihl grondboren) De DG002G heeft een as-gat opname waar de Makita grondboren rechtstreeks op passen.



	DG001GZ05	DG001GM105	DG002GZ
Spanning	36V (40Vmax)	36V (40Vmax)	36V (40Vmax)
Bijgeleverde accu's	-	1x BL4040	-
Bijgeleverde lader	-	DC40RA	-
Max. diameter boor	200 mm	200 mm	200 mm
Opname	Boorkop	Boorkop	Directe opname
Max. koppel	136 Nm	136 Nm	136 Nm
Toerental onbelast	0 - 350 min ⁻¹ 0 - 1400 min ⁻¹	0 - 350 min ⁻¹ 0 - 1400 min ⁻¹	0 - 350 min ⁻¹ 0 - 1400 min ⁻¹
Gewicht	7,2 - 8,1 kg	7,2 - 8,1 kg	7,2 - 8,1 kg
Prijs in €	excl. btw	€ 627,27	€ 891,74
	incl. btw	€ 759,00	€ 1.079,00
		€ 544,63	€ 659,00

UP100D

SNOEISCHAAR 12VMAX



UP100D - DUP180Z

- Uiterst licht en smalle greep dankzij ultracompacte BL motor zonder metalen kern
- Werkt zeer comfortabel dankzij servosturing (de schaar volgt exact de beweging van de trigger)
- De bladopeningshoek kan in verschillende posities ingesteld worden afhankelijk van de dikte van de takken, dit werkt tijdsbesparend.
- **DUP180:** versie voor LXT accu's, met batterijadapter die aan de heup bevestigd wordt en een kabel naar de snoeischaar.
- **UP100D:** versie voor CXT accu's, de accu zit achteraan op de snoeischaar. Bijzonder geschikt voor fijn snoeiwerk.



UP100DSMJ

Spanning	10,8V	
Bijgeleverde accu's	1x BL1041B	
Bijgeleverde lader	DC10SB	
Maximaal afgegeven vermogen	170 W	
Snijcapaciteit	25 mm	
Afmetingen (L x B x H)	259 x 53 x 98 mm	
Gewicht	0,89 - 1,1 kg	
Prijs in €	excl. btw	€ 784,30
	incl. btw	€ 949,00

DUP180

ACCU SNOEISCHAAR 18V



NIEUW DUP180Z



De bladopeningshoek kan in verschillende posities ingesteld worden

Spanning	18V	
Bijgeleverde accu's	-	
Bijgeleverde lader	-	
Maximaal afgegeven vermogen	370 W	
Snijcapaciteit	30 mm	
Afmetingen (L x B x H)	296 x 40 x 99 mm	
Gewicht	0,68 kg	
Prijs in €	excl. btw	€ 701,65
	incl. btw	€ 849,00

DUP362

ACCU SNOEISCHAAR 2 x 18 V



Inclusief
harnas & holster

DUP362Z DUP362PT2

Bijgeleverde accu's	-	2 x accu 5,0 Ah	
Bijgeleverde lader	-	DC18RD	
Snijcapaciteit	33 mm	33 mm	
Gewicht	3,3 kg	3,3 kg	
Prijs in €	excl. btw	€ 1.230,58	€ 1.503,31
	incl. btw	€ 1.489,00	€ 1.819,00

UD2500

ELEKTRISCHE HAKSELAAR



UD2500

Nominaal vermogen	2500 W	
Max. toerental onbelast	40 t.p.m	
Max. takdikte	45 mm	
Geluidsdruk	84 dB(A)	
Gewicht	29,7 kg	
Prijs in €	excl. btw	€ 329,75
	incl. btw	€ 399,00

DCU180Z

ACCU KRUIWAGEN 18 V



Elektronische snelheidsregeling



Demonteerbare achterwielen



Geïntegreerde ledverlichting



PROMO

GRATIS BUIZENFRAME
(199009-8)



		DCU180Z
Spanning		18 V
Rijsnelheid		0 - 3,5 km/u
Draagvermogen		130 kg
Max. helling		12°
Gewicht		39,3 - 44,8 kg
Prijs in €	excl. btw	€ 1.023,97
	incl. btw	€ 1.239,00

DCU603 / DCU604 / DCU605 / DCU601 / DCU602

ACCU TRANSPORTERS 2 X 18 V



DCU603

Met kuip en manuele kiepfunctie



DCU605

Met vaste, vlakke kuip



DCU604

Met frame en manuele kiepfunctie



DCU601

Plateau met elektrische lift



DCU602

Met kuip en elektrische kiepfunctie



DCU601Z

- Transporter met elektrohydraulische lift
- Ideaal voor het optillen van zware lasten om bijvoorbeeld over te laden in een bestelwagen of aanhangwagen
- De zijsteunen kunnen verlaagd worden tot onder het platform
- Maximum hefcapaciteit 300 kg



DCU602Z

- Dumper met elektrohydraulische kiepfunctie
- De laadbak kan elektrisch worden gekiept tot 75° en handmatig tot 110°.
- Maximum hefcapaciteit 300 kg

		DCU603Z	DCU604Z	DCU605Z	DCU601Z	DCU602Z
Spanning		2 x 18V	2 x 18V	2 x 18V	2 x 18V	2 x 18V
Type		Kantelbare kuip	Kantelbaar frame	Vaste kuip	Plateau met elektrische lift	Elektrisch kantelbare kuip
Volume kuip		100 l	-	250 l	-	100 l
Max. lading vlak terrein		300 kg	300 kg	300 kg	300 kg	300 kg
Max. lading helling (3° - 12°)		180 kg	180 kg	180 kg	180 kg	180 kg
Rijsnelheid vooruit		1,5 - 3,5 - 5,0 km/h	1,5 - 3,5 - 5,0 km/h	1,5 - 3,5 - 5,0 km/h	1,5 - 3,5 - 5,0 km/h	1,5 - 3,5 - 5,0 km/h
Rijsnelheid achteruit		1,0 km/h	1,0 km/h	1,0 km/h	1,0 km/h	1,0 km/h
Gewicht		122 - 124 kg	122 - 124 kg	122 - 124 kg	145 kg	147 kg
Prijs in €	excl. btw	€ 4949,59	€ 4949,59	€ 4767,77	€ 5.990,91	€ 5.990,91
	incl. btw	€ 5989,00	€ 5989,00	€ 5769,00	€ 7.249,00	€ 7.249,00

NIEUW

NIEUW



DUC353Z DUC405Z
 € 351,24 excl. btw € 376,03 excl. btw
 € 425,00 incl. btw € 455,00 incl. btw

DUR368LZ
 € 313,22 excl. btw
 € 379,00 incl. btw

DUR190UT11
 € 362,81 excl. btw
 € 439,00 incl. btw

DUR369AZ
 € 412,40 excl. btw
 € 499,00 incl. btw

DUR368AZ
 € 354,55 excl. btw
 € 429,00 incl. btw

DLM481CT2
 € 784,30 excl. btw
 € 949,00 incl. btw

DLM539CT2
 € 825,62 excl. btw
 € 999,00 incl. btw

DLM536Z
 € 933,06 excl. btw
 € 1.129,00 incl. btw

DLM537Z
 € 1.313,22 excl. btw
 € 1.589,00 incl. btw

DLM463Z
 € 594,21 excl. btw
 € 719,00 incl. btw

DLM463PT2
 € 866,94 excl. btw
 € 1.049,00 incl. btw

DLM465Z
 € 904,96 excl. btw
 € 1.095,00 incl. btw

DLM465PT2
 € 1.156,20 excl. btw
 € 1.399,00 incl. btw



1 accu 5,0 Ah gratis na online registratie
 Bij aankoop van een LXT machine

PROMO
 BL1850B



Z-versies
 geleverd zonder
 batterijen of lader

**1 accu 4,0 Ah na
 online registratie**



LM003GM102
 € 508,26 excl. btw
 € 615,00 incl. btw

LM004GM102
 € 528,10 excl. btw
 € 639,00 incl. btw

PROMO
 BL440

Promo: gratis artikelen direct geleverd bij de machines

PROMO
 831253-8

PROMO
 E-08458



GRATIS
 Gereedschapsset



DUC256Z001

DUC256Z001
 € 400,83 excl. btw
 € 485,00 incl. btw

DUC356Z001
 € 409,09 excl. btw
 € 495,00 incl. btw

DUC406Z001
 € 412,40 excl. btw
 € 499,00 incl. btw

DUC306Z001
 € 404,13 excl. btw
 € 489,00 incl. btw



GRATIS
 Opbergtas



UM600DSAEX
 € 202,48 excl. btw
 € 245,00 incl. btw

DUM604RFEX
 € 268,60 excl. btw
 € 325,00 incl. btw



DUM111SYX
 € 161,16 excl. btw
 € 195,00 incl. btw

DUM604ZX



Bij aankoop van een 40Vmax machine hieronder

Gratis promo na online registratie

PROMO
 AS001GT



GRATIS
 Blaas- en zuigmachine

UC003GM101
 € 685,12 excl. btw
 € 829,00 incl. btw

UC004GM101
 € 690,08 excl. btw
 € 835,00 incl. btw

UC002GM101
 € 681,82 excl. btw
 € 825,00 incl. btw

UC010GT101
 € 855,37 excl. btw
 € 1.035,00 incl. btw

UC011GT101
 € 875,21 excl. btw
 € 1.059,00 incl. btw

UC012GT102
 € 880,17 excl. btw
 € 1.065,00 incl. btw

UC013GT102
 € 883,47 excl. btw
 € 1.069,00 incl. btw



UC003GM101



UB001GM101

UB001GM101
 € 544,63 excl. btw
 € 659,00 incl. btw

UH007GM201

UH004GM201
 € 891,74 excl. btw
 € 1.079,00 incl. btw

UH006GM201
 € 891,74 excl. btw
 € 1.079,00 incl. btw

UH013GM101
 € 962,81 excl. btw
 € 1.165,00 incl. btw

UH007GM201
 € 908,26 excl. btw
 € 1.099,00 incl. btw

UH005GM201
 € 908,26 excl. btw
 € 1.099,00 incl. btw

UH014GM101
 € 990,91 excl. btw
 € 1.199,00 incl. btw



DG001GM105

DG001GM105
 € 891,74 excl. btw
 € 1.079,00 incl. btw

PROMO
 DMR057



GRATIS
 Lantaarn met
 radio en
 Bluetooth



DUH501RTE

DUH501RTE
 € 541,32 excl. btw
 € 655,00 incl. btw

Deze XGT machines
 worden geleverd met
 batterij(en) en lader



Ontvang een gratis cadeau!

Van 01 januari 2024 t.e.m. 31/12/2024 kan u bij aankoop van de bovenstaande producten een gratis cadeau aanvragen! Voor de gratis producten na online registratie: surf naar www.makita.be en vul het formulier in dat u kan terug vinden in 'Mijn Makita'. Na ontvangst van de correcte gegevens sturen we het gratis product zo snel mogelijk naar u toe.

De actie is uitsluitend van toepassing op aankopen bij een officieel erkende Makitaverdeler. Deze kan u terugvinden in de dealerlocator op www.makita.be. De complete voorwaarden van deze actie zijn na te lezen op de actiepagina in 'Mijn Makita'. Actie niet cumuleerbaar met andere acties en niet van toepassing op machines die deel uitmaken van een combikit of een omruiling in het kader van een reparatie.

DLX4181PT2

ACCU COMBOPACK TUIN

18V → 36V

18V LITHIUM-ION

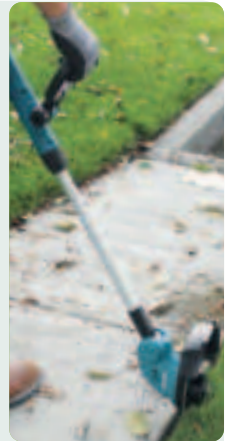

DLX4181PT2

Bijgeleverde accu's	2 x accu 5,0 Ah	
Duo snellader	DC18RD	
Heggenschaar	DUH507	
Bladblazer	DUB184	
Gastrimmer	DUR193	
Grasmaaier	DLM432	
Prijs in €	excl. btw	€ 866,94
	incl. btw	€ 1049,00

DLX5057PTJ

ACCU COMBOPACK TUIN

18V → 36V

XPT

BL MOTOR

18V LITHIUM-ION



DLX5057PTJ

Bijgeleverde accu's	4 x accu 5,0 Ah	
Duo snellader	DC18RD	
Heggenschaar	DUH601	
Kettingzaag	DUC353	
Gastrimmer	DUR368	
Grasmaaier	DLM460	
Bladblazer	DUB362	
Prijs in €	excl. btw	€ 2.065,29
	incl. btw	€ 2.499,00



Scan hier
voor info
over BAC01



Makita[®]



www.makita.be



Jan-Baptist Vinkstraat 2
B-3070 Kortenberg

Afbeeldingen kunnen afwijken van het origineel. Technische gegevens en prijzen zijn indicatief en onder voorbehoud van drukfouten. Aanbevolen prijzen excl. bebat en recupel. Registratienummer/milieubelasting: 400/0000042/81. Promoties geldig tot einde voorraad

REF : PLFNL24